

Important safety instructions.....	1
Specified Conditions of Use .....	2
Error Code Table .....	2
Overview.....	3
Change batteries .....	4
Corner Pin .....	4
Belt Clip .....	4
Function Switch, Measuring Reference, Pythagoras.....	5
Single Distance Measuring.....	6
Permanent / Minimum-Maximum Measuring.....	7
Add / Subtract Measuring.....	8
Area Measuring.....	9
Volume Measuring.....	10
Indirect Measuring (Pythagoras 1) .....	11
Indirect Measuring (Pythagoras 2) .....	12
Indirect Measuring (Pythagoras 3) .....	13
Wall Area Measuring (Scenario 1).....	14
Wall Area Measuring (Scenario 2).....	15
Timer .....	16
Memory.....	16
Basic Description on example of Area measuring (1).....	17
Basic Description on example of Area measuring (2).....	18

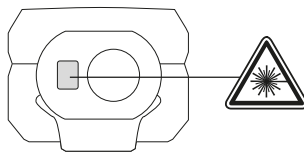

Do not use the product before you have studied the Safety instructions and the User Manual.

**Laser Classification****WARNING:**

It is a Class 2 laser product in accordance with EN 60825-1:2007.

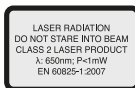
**Labeling**

We have supplied you with an adhesive label in your language and now request that you please apply this in place of the English text on the specification plate before first commissioning the machine.

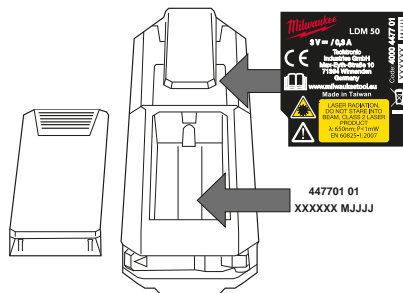
**WARNING:**

Avoid direct eye exposure. The laser beam can cause flash blindness.

Do not stare into the laser beam or direct it towards other people unnecessarily.

Don't dazzle other individuals.

**WARNING:**

Do not operate the tool around children or allow children to operate the tool.

The reflective surface could reflect the beam back at the operator or other persons.

Keep extremities in a safe distance from the moving parts.

Carry out periodic test measurements. Particularly before, during and after important measurements.

Watch out for erroneous measurements if the product is defective or if it has been dropped or has been misused or modified.

**WARNING:** Use of controls, adjustments, or the performance of procedures other than those specified in the manual may result in hazardous radiation exposure.

The laser distance measurer has limits of use. (Refer to the "Technical data" section). Attempts to measure outside the maximum and minimum range will cause inaccuracy. Use in adverse conditions including too hot, too cold, very bright sunlight, rain, snow, fog, or other vision restricting conditions will result in inaccurate readings.

When the laser distance measurer is brought into a warm environment from very cold conditions, or vice versa, allow it to come to the surrounding temperature before use.

Always store the laser distance measurer indoors, avoid exposing the tool to shock, continuous vibration or extreme temperatures.

Always keep the tool away from dust, liquids and high humidity. These may damage internal components or affect accuracy.

Do not use aggressive cleaning agents or solutions. Use only a clean, soft cloth for cleaning.

Avoid heavy impact to or dropping of the measuring tool. The accuracy of the tool should be checked before use if it has been dropped or subjected to other mechanical stresses.

Any repair required on this laser product should be performed only by authorised service personnel.

Do not operate the product in explosion hazardous areas or in aggressive environments.

Only use chargers recommended by the manufacturer to charge the batteries.



Flat batteries must not be disposed of with household waste. Care for the environment and take them to the collection points provided in accordance with national or local regulations. The product must not be disposed with household waste. Dispose of the product appropriately in accordance with the national regulations in force in your country. Adhere to the national and country specific regulations. Please contact your local authority or your dealer for how to dispose of batteries properly.

**CE** European Conformity Mark

## TECHNICAL DATA

Dust and Water resistance	IP54
Receiving Lens	14 mm
Focus	35 mm
Maximum Measuring Range	50 meters (Tolerance : 55m)
Minimum Measuring Range	0.05 meters
Absolute Accuracy @ < 10m	± 1.5 mm (Max)
Repeatability Accuracy @ < 10m	± 1.5 mm (Max Typical, 2σ)
Repeatability Accuracy @ > 10m	Increase ± 0.25 mm / meter (Max Typical, 2σ)
Measurement Time	0.5 s
Display Type	LCD ( 22.7 mm x 31 mm )
Power Type	AAA 2x (Alkaline Battery)
Battery Life	10000 (Single Measure)
Laser Output Power	0.6 mW ~ 0.95 mW (Class 2, 650nm )
Laser Spot Size	25 x 30 mm @ 16 m (Max)
Laser Radiation Vertical Angle	+1 degree
Laser Radiation Horizontal Angle	±1 degree
Device auto off time	180 seconds
Laser auto off time	30 seconds
Operating Temperature Range	-10°C to +50°C
Storage Temperature Range	-25°C to +70°C
Weight without Battery	80 g

## SPECIFIED CONDITIONS OF USE

The laser distance measurer can be used for measuring distances and tilts.  
Do not use this product in any other way as stated for normal use.

## ERROR CODE TABLE

Code	Description	Solution
Err01	Out of measuring range	Measure in a proper range
Err02	Reflect signal is too weak	Choose a better surface
Err03	Out of display range (max value: 99.999) e.g. result of area or volume is out of display range	Check and verify values and steps are correct
Err04	Pythagorean calculation error	Check and verify values and steps are correct
Err05	Battery is low	Install new batteries
Err06	Out of working temperature	Measure in an environment with the specified working temperature
Err07	Ambient light is too strong	Measure in a darker place (shadow target)

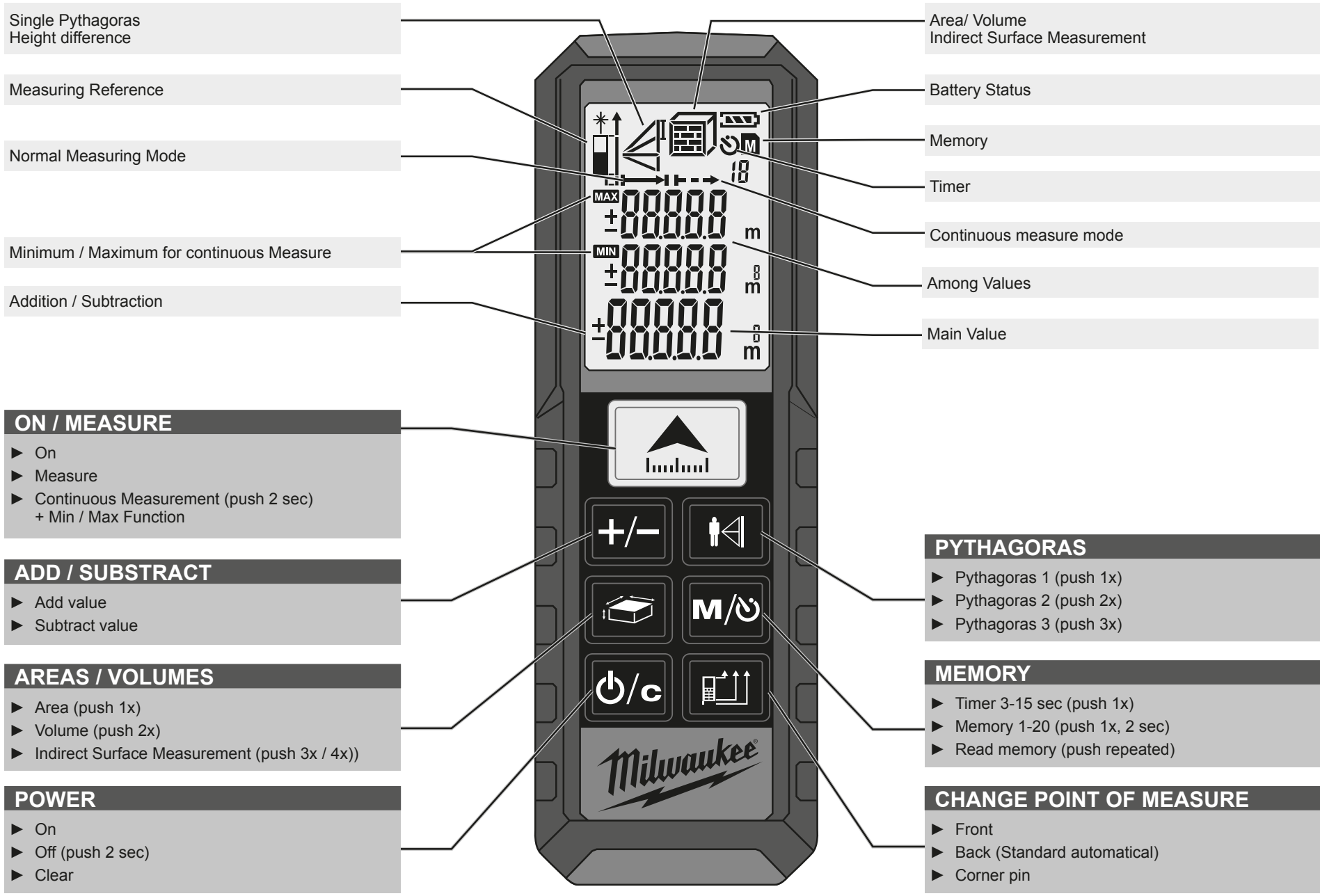

## CHANGE BATTERIES

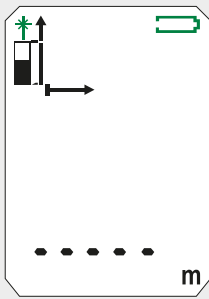

Change batteries when battery symbol is flashing.

1

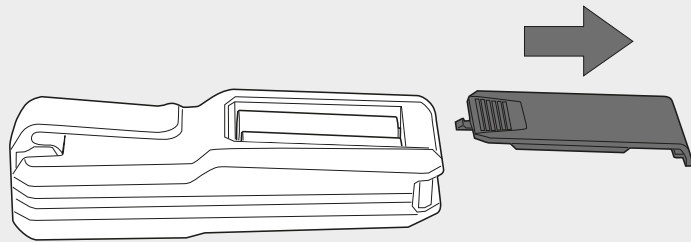

2

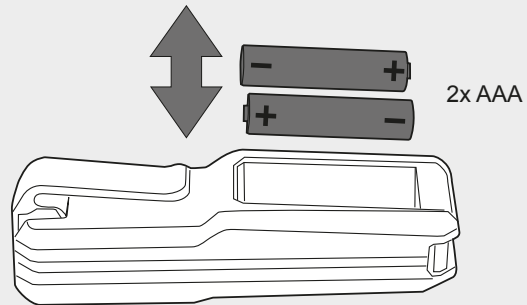

3

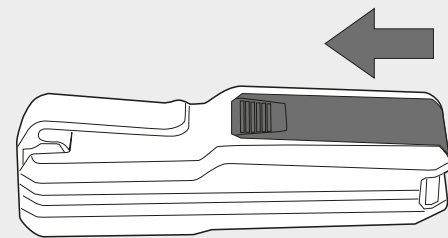

## CORNER PIN

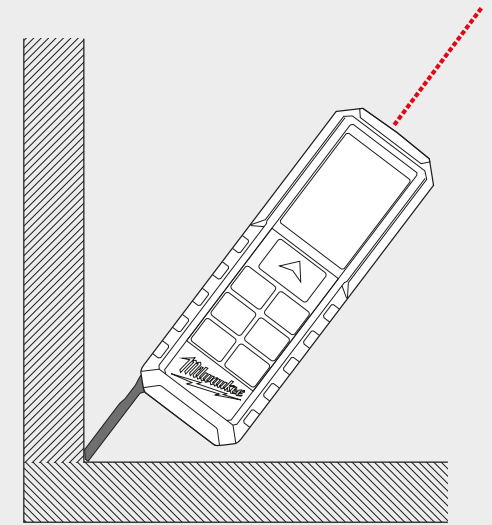
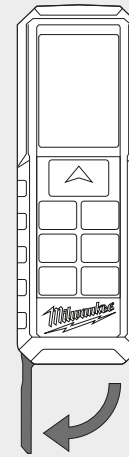

## BELT CLIP

1

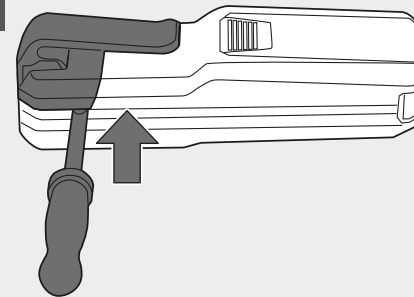

2

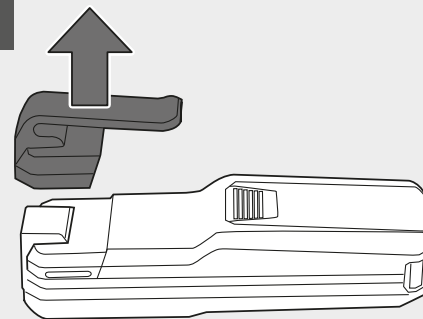

3

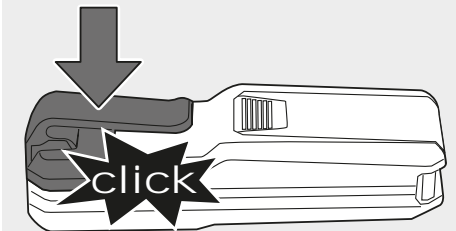

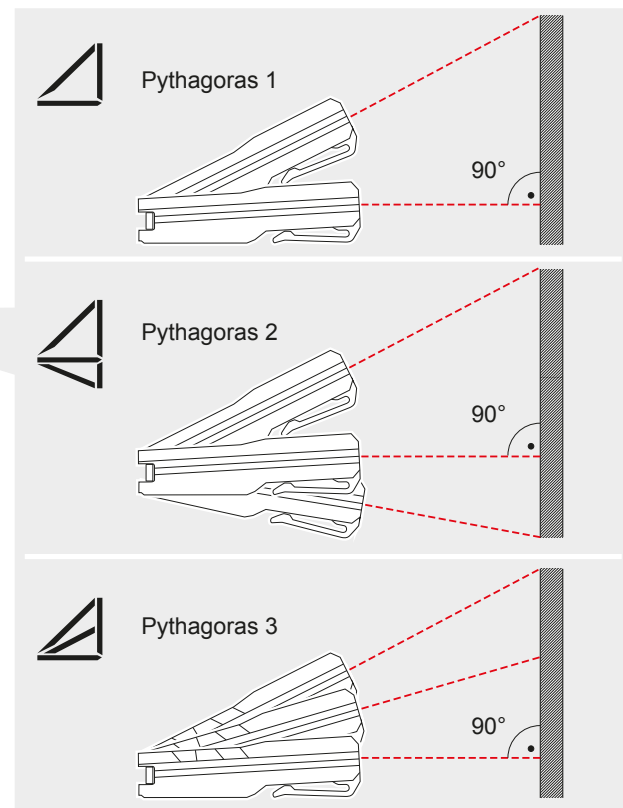
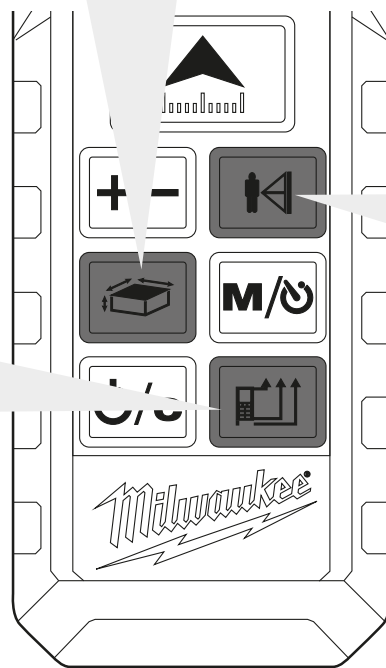
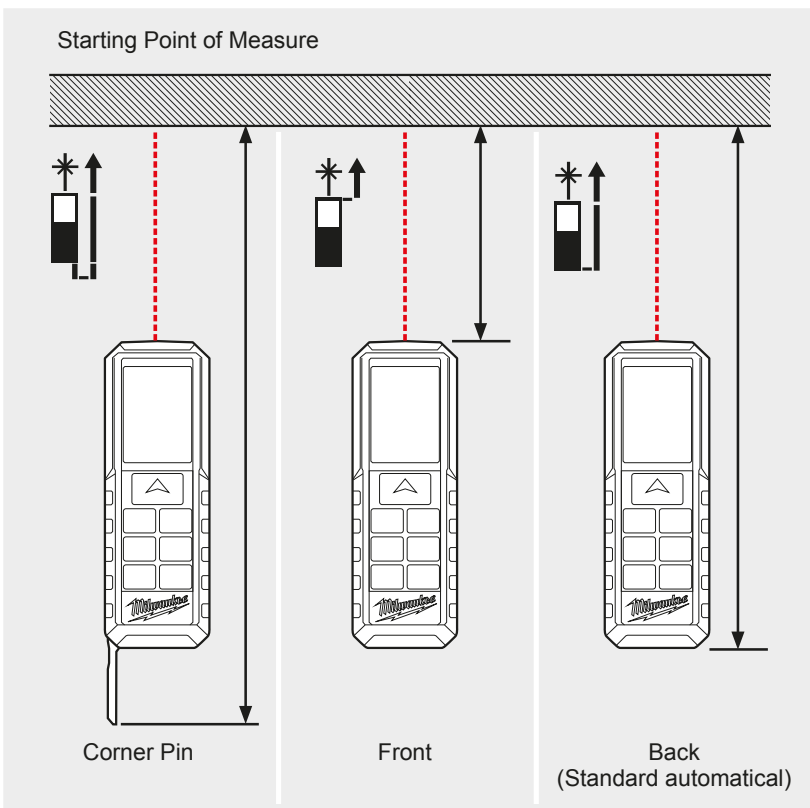
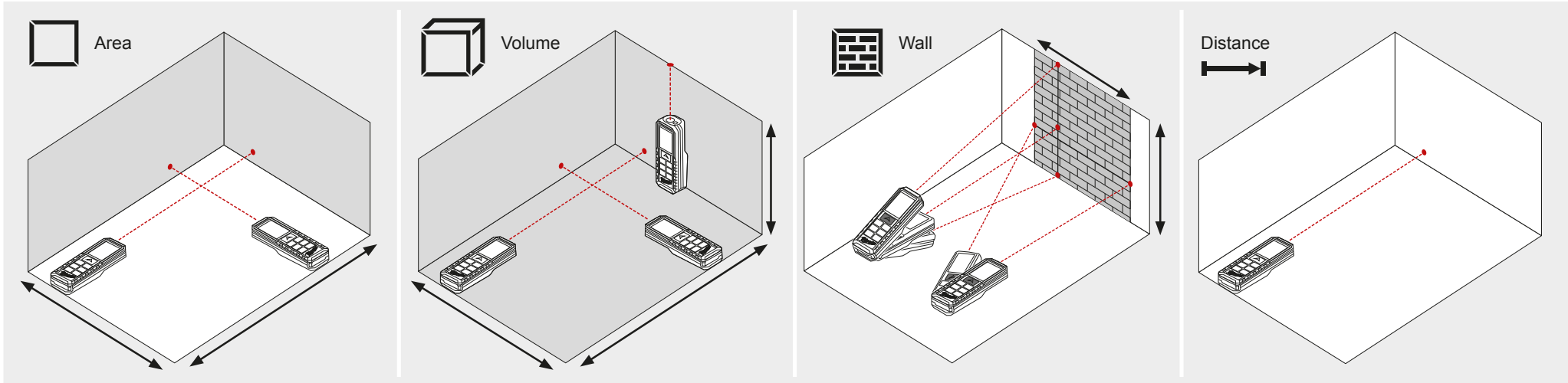

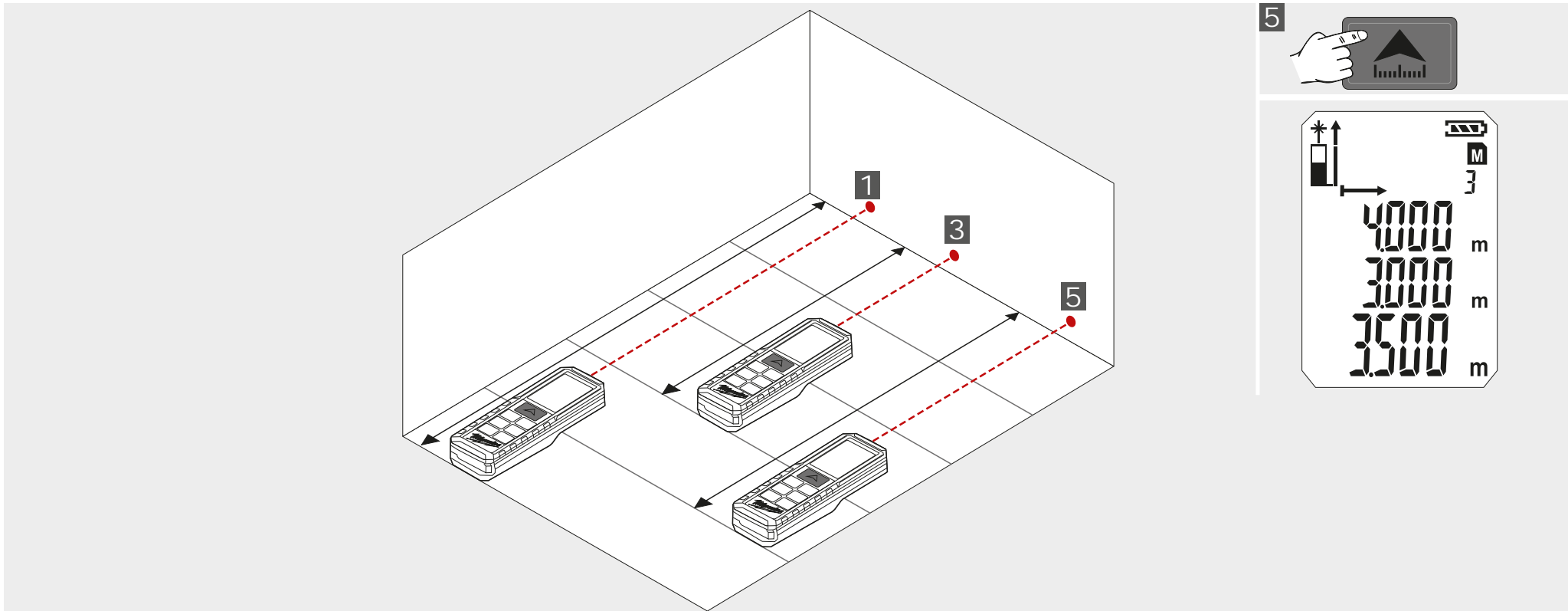
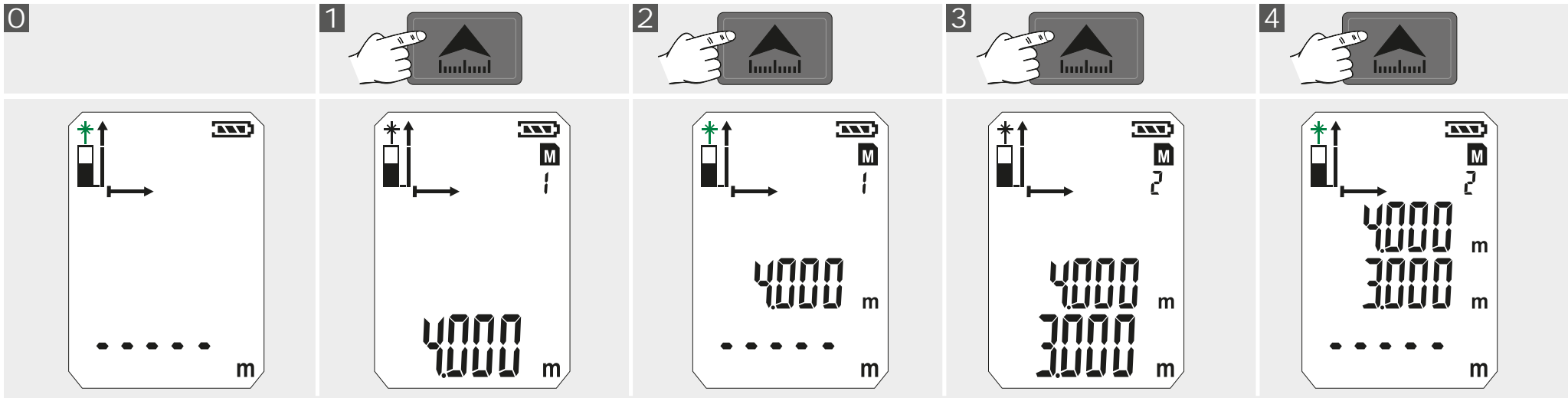

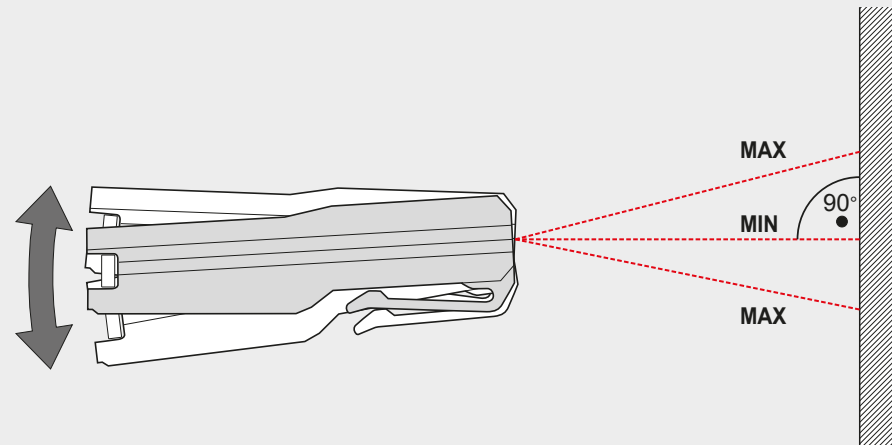
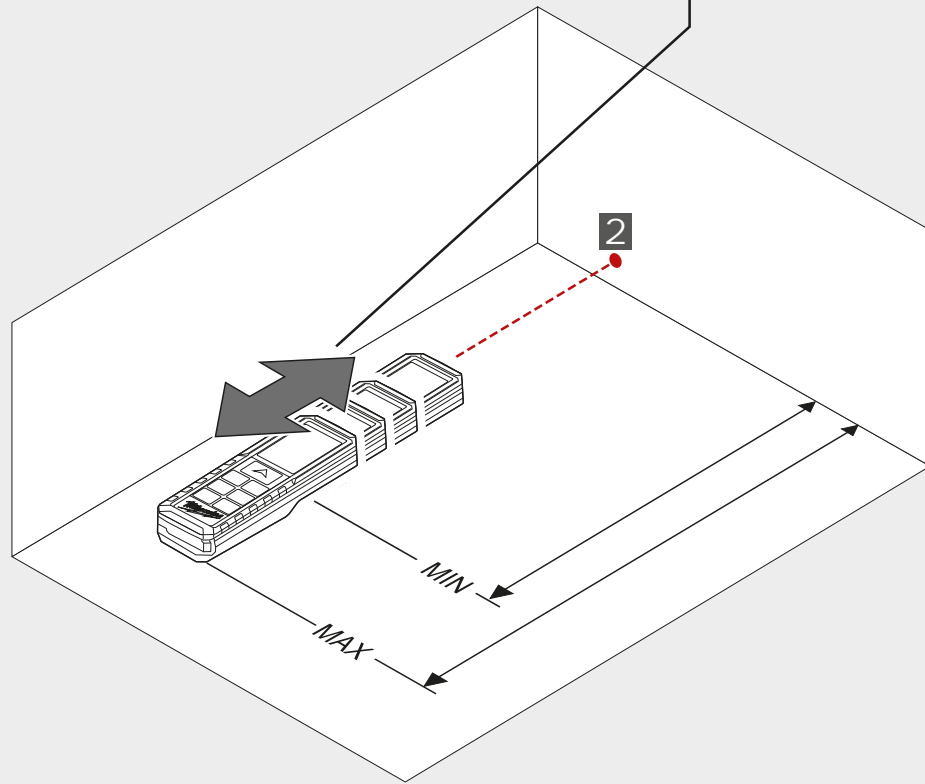
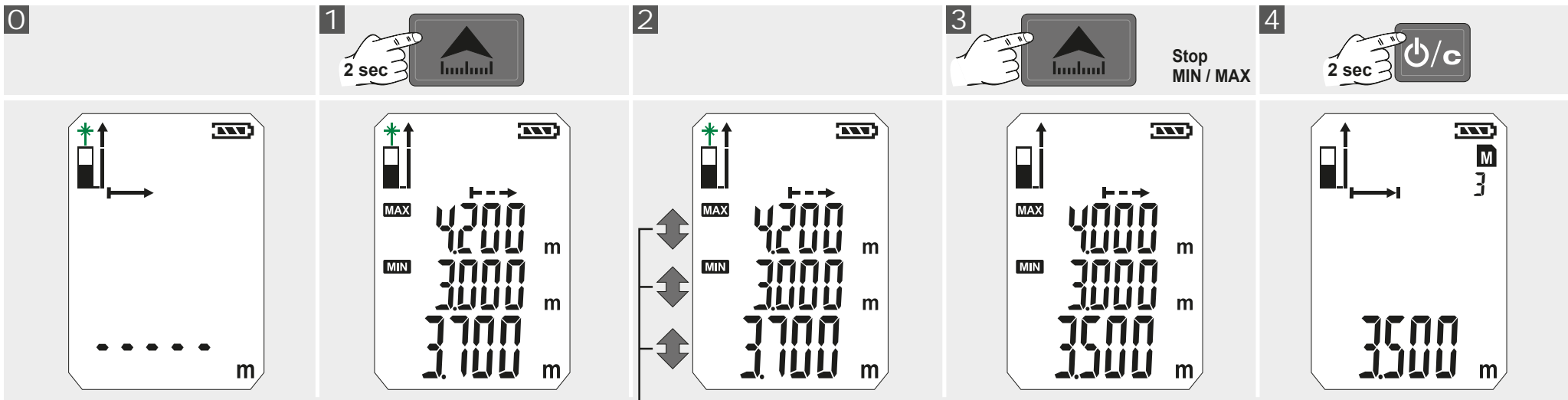

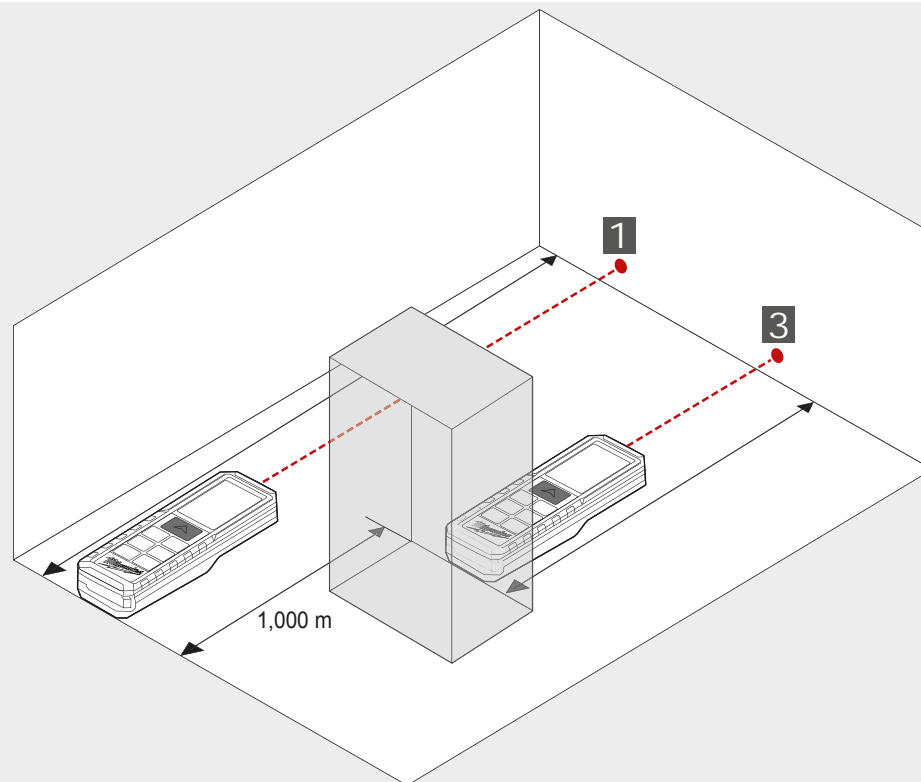
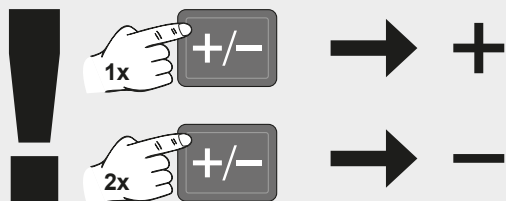
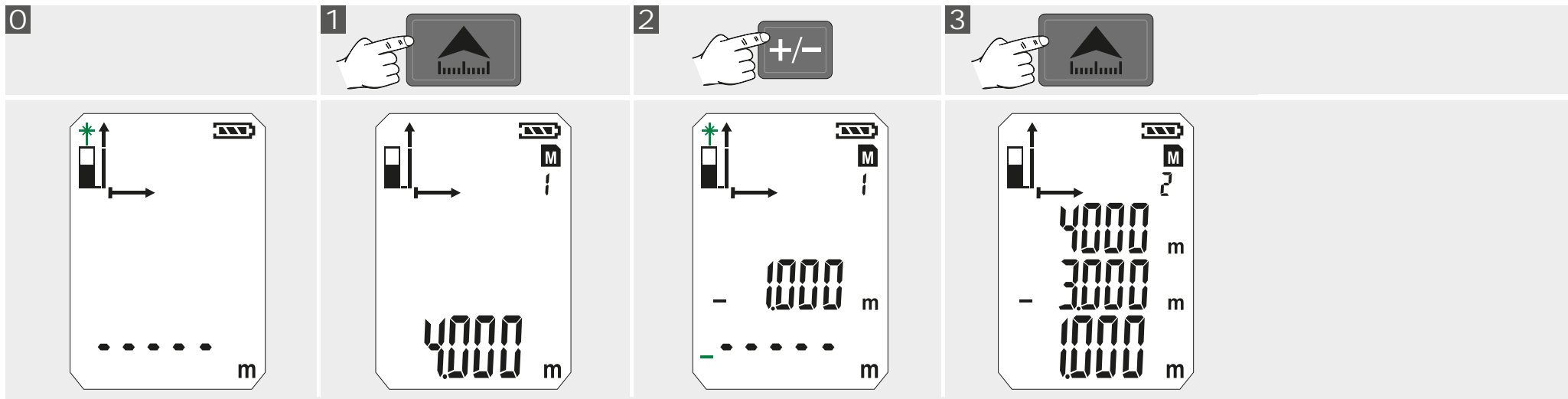



0



1



2

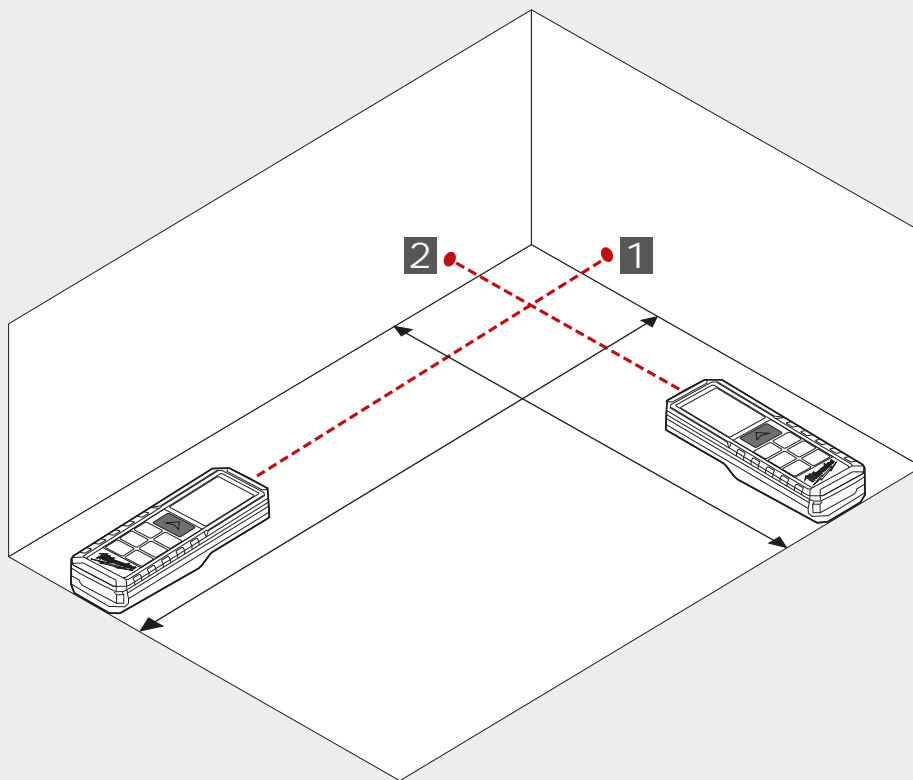
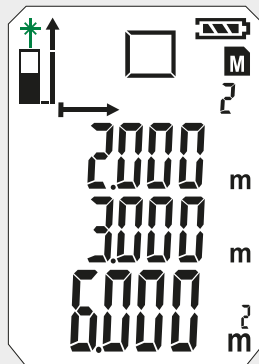
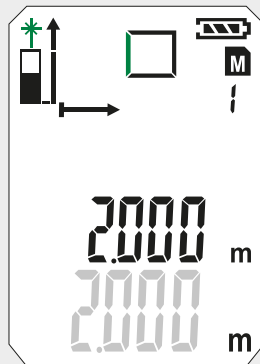
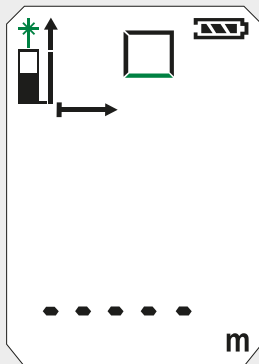

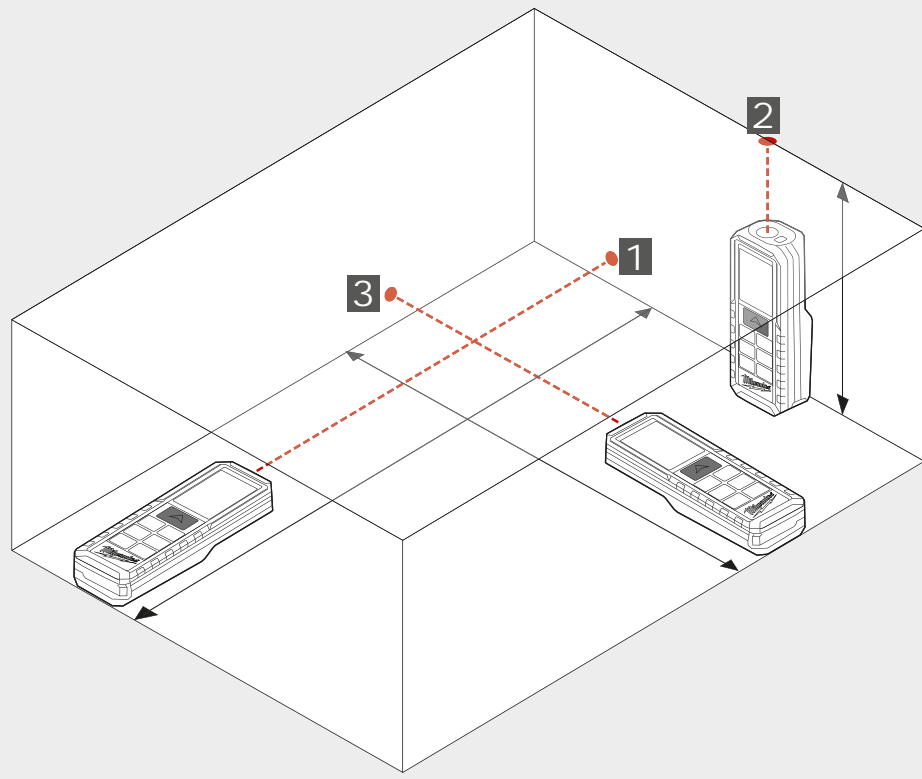
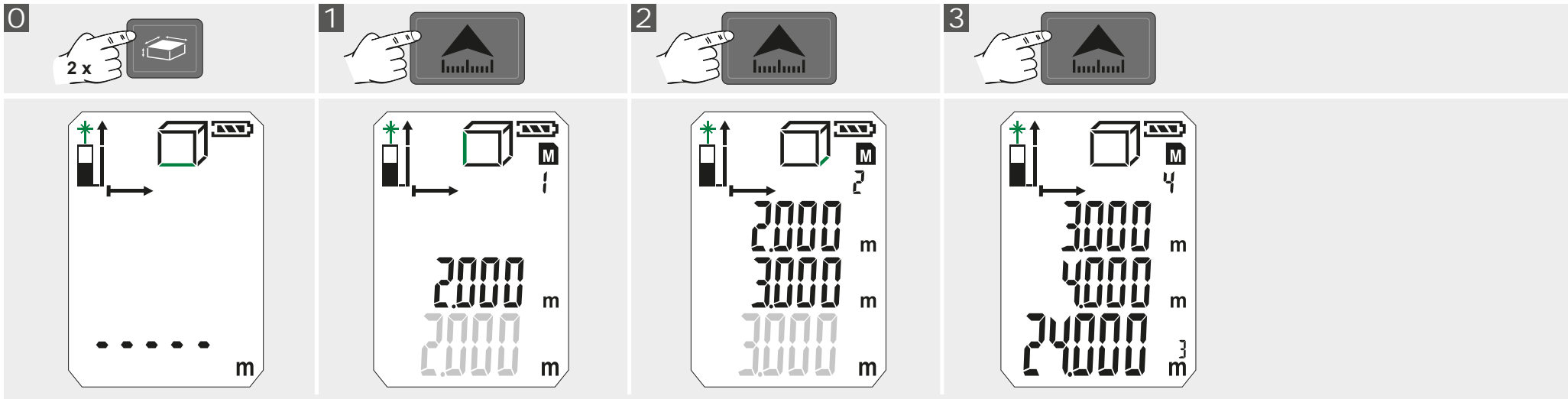

0

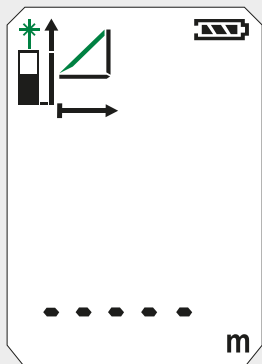

1

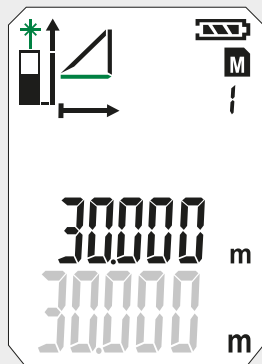



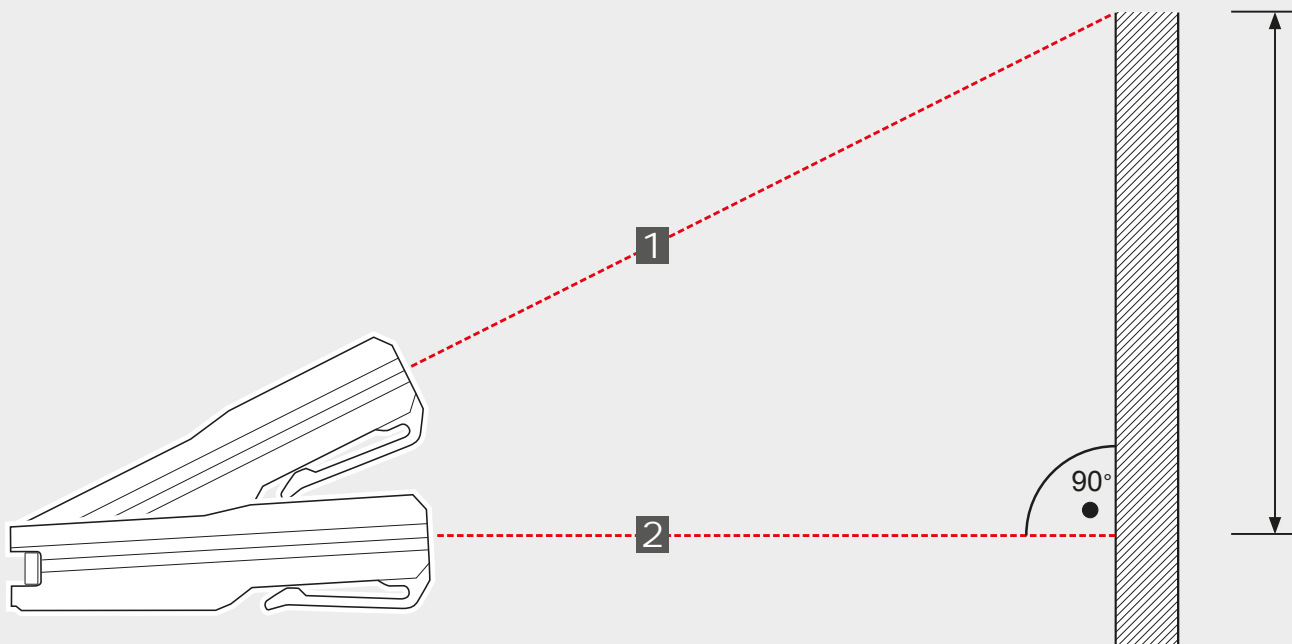
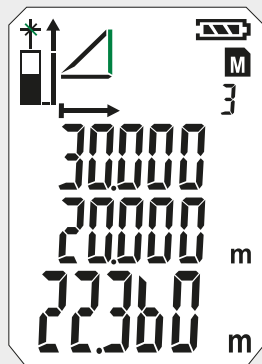

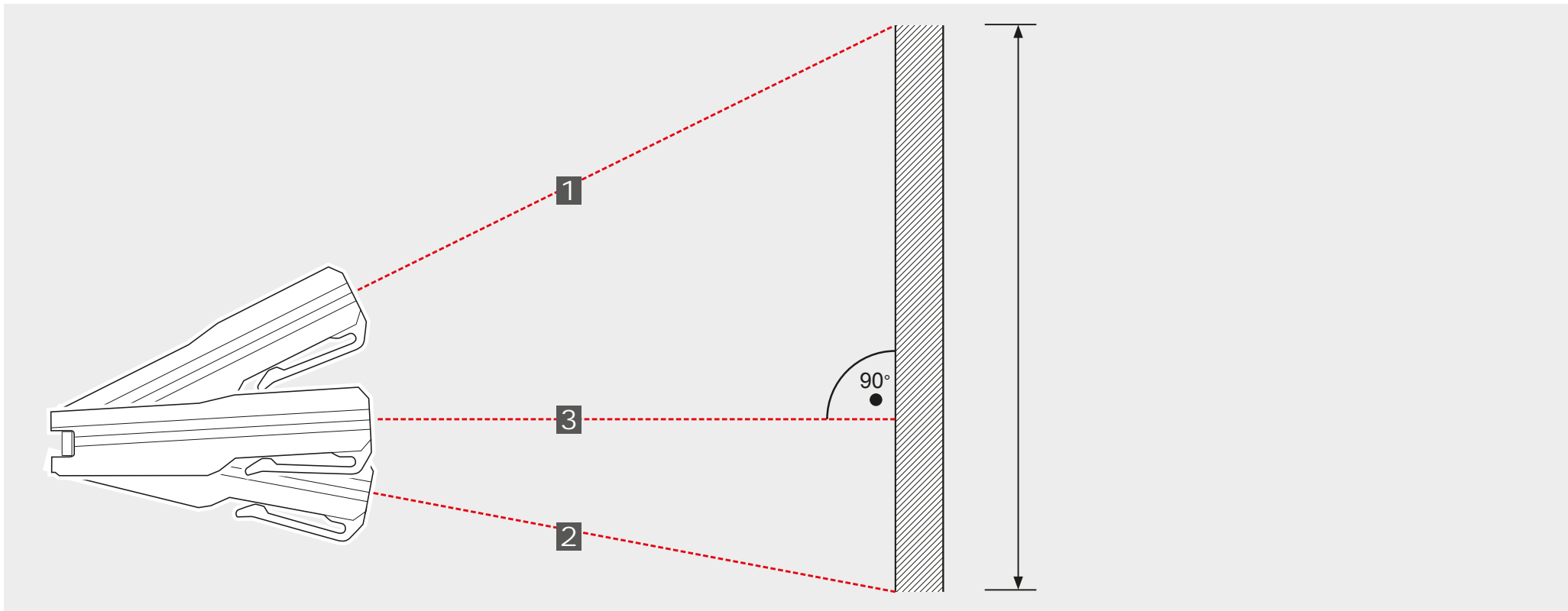
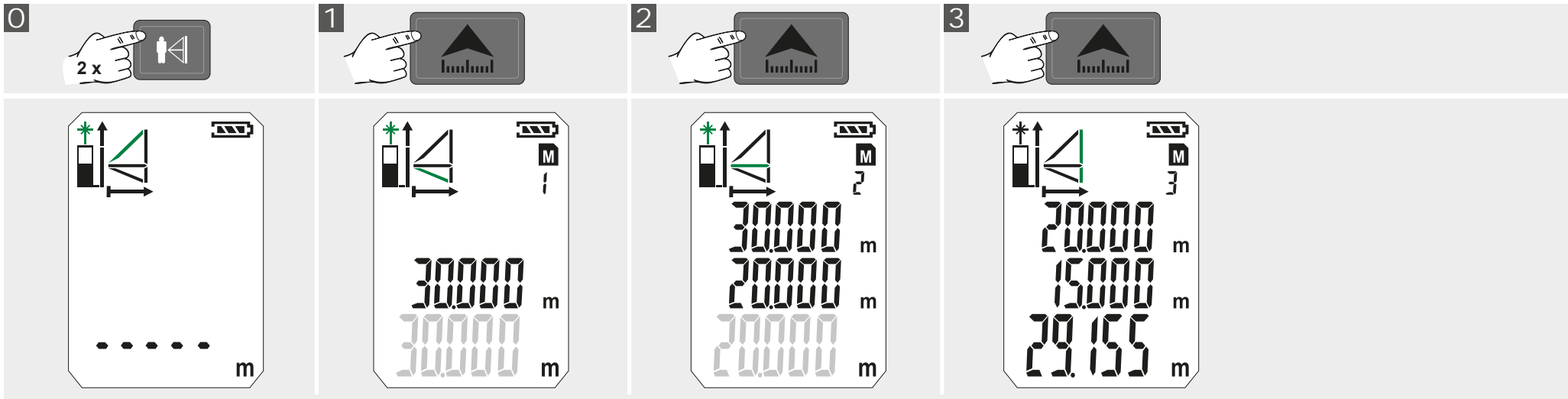
2

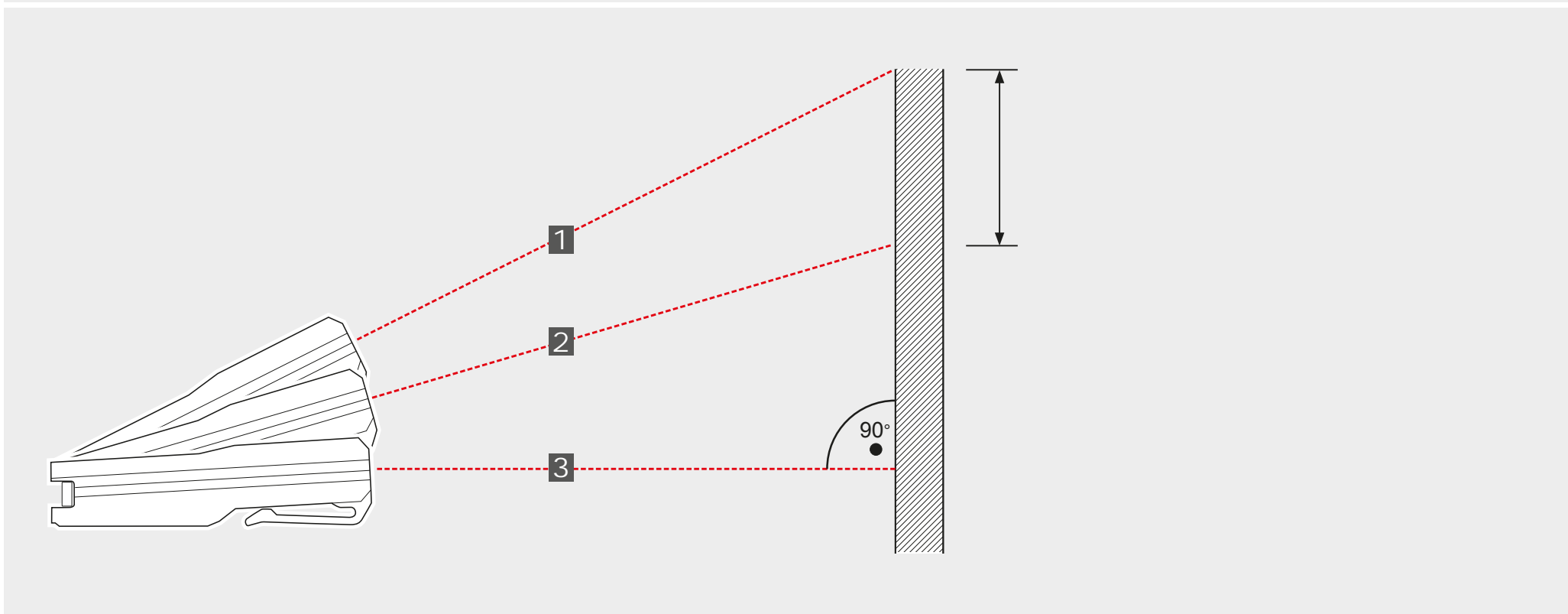
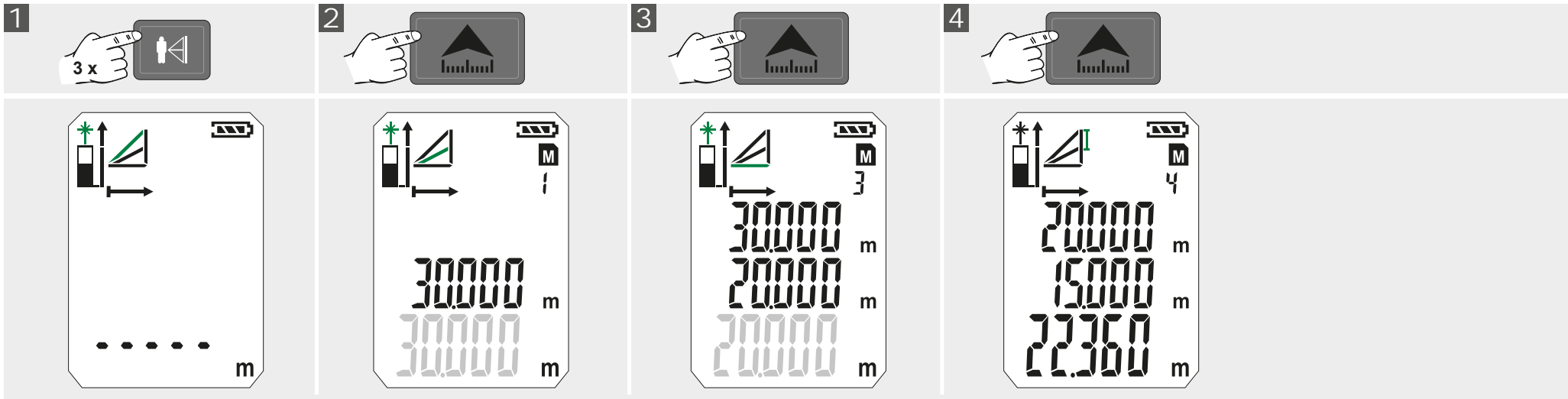



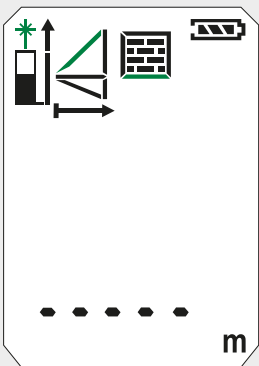
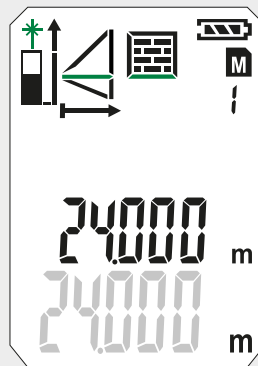
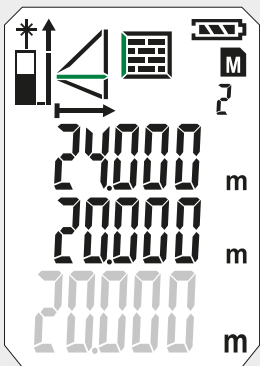
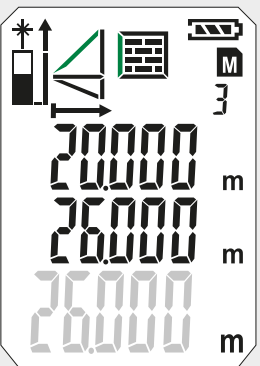
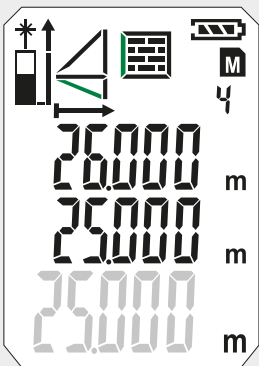

<p>0</p>  <p>3 x</p>	<p>1</p> 	<p>2</p> 	<p>3</p> 	<p>4</p> 
				

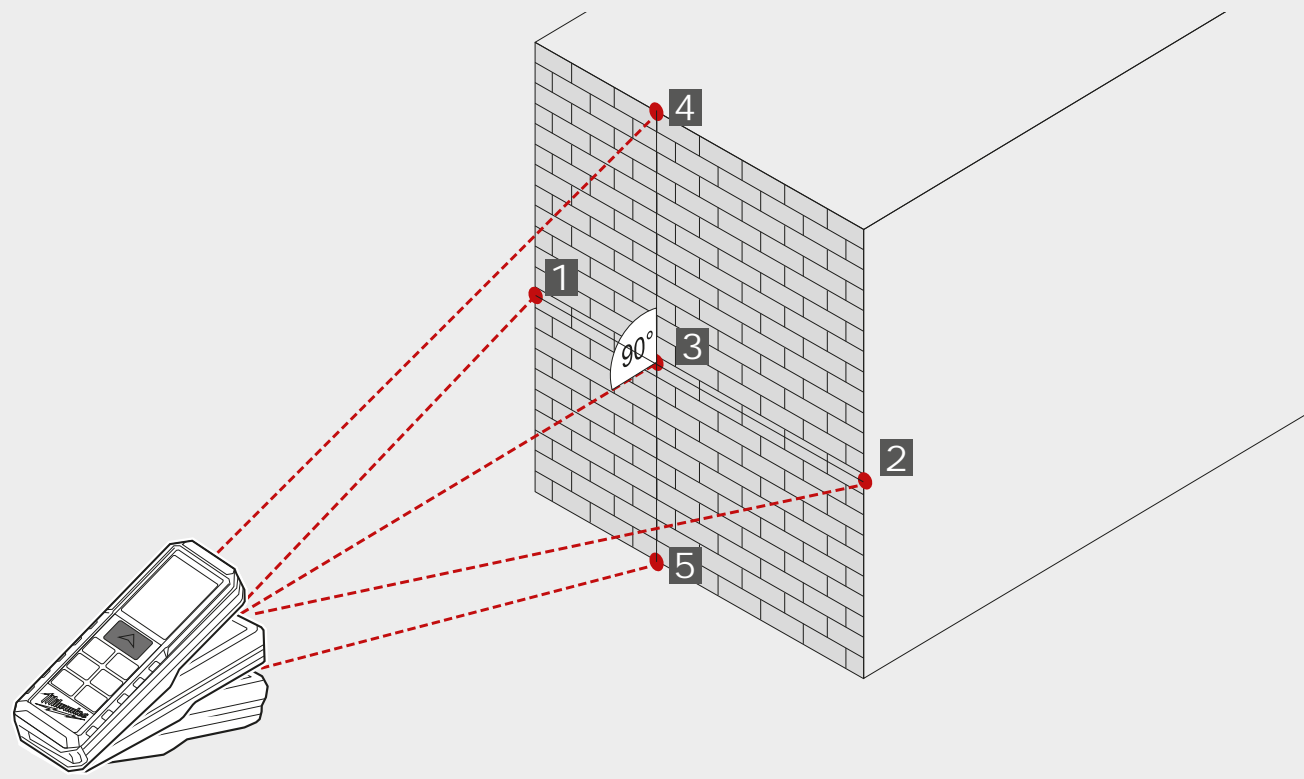
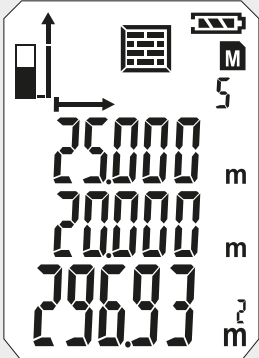





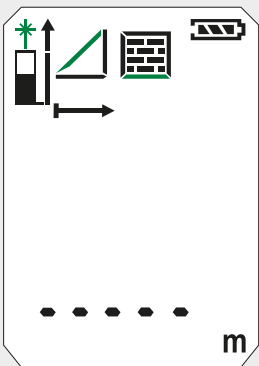
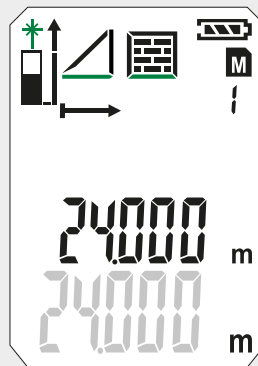
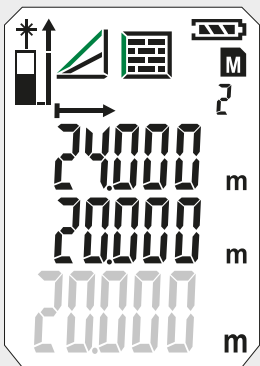
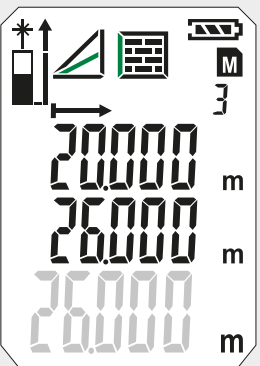
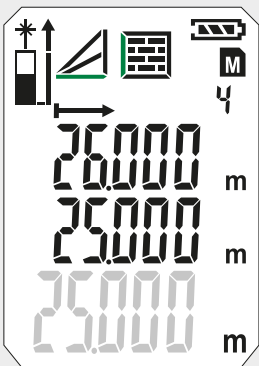
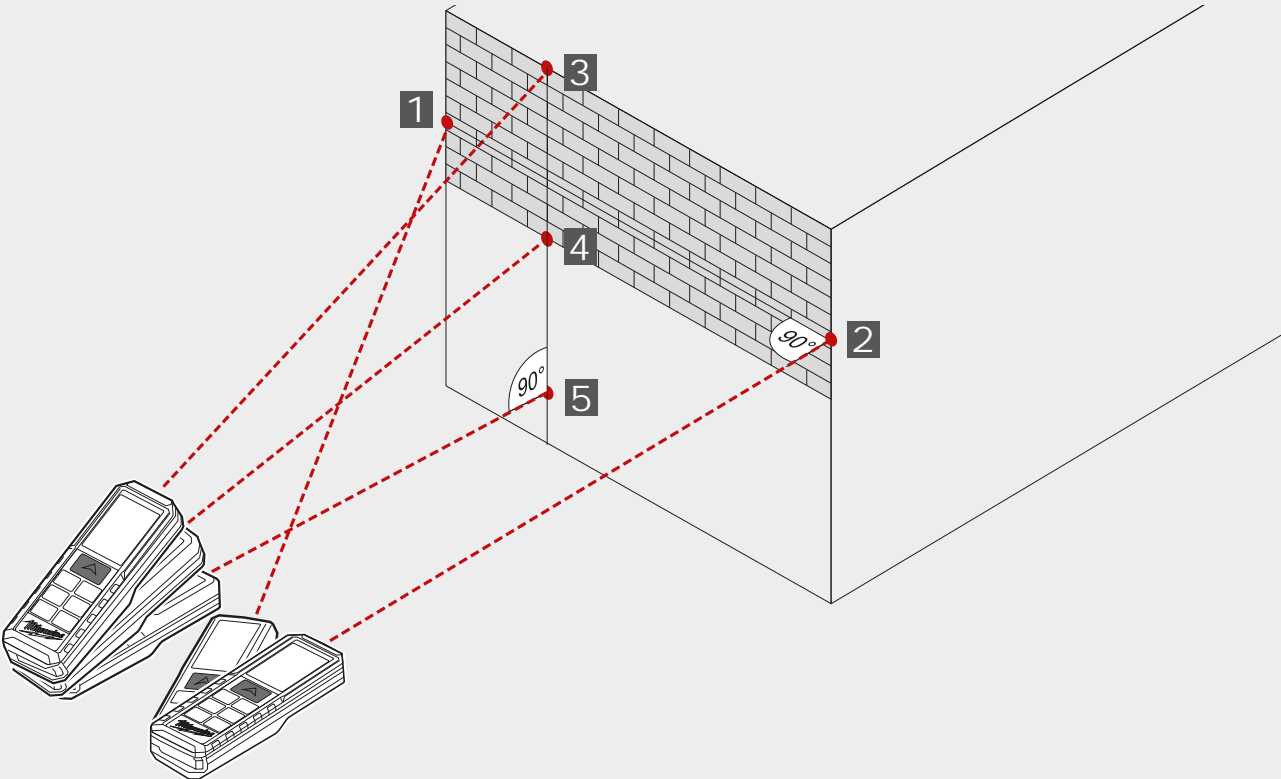



Diagram illustrating the wall area measuring process. A hand-held device is shown measuring a wall. Red dashed lines indicate the measurement path from the device to points 1, 2, 3, 4, and 5 on the wall. A 90-degree angle is marked at point 3. The device's LCD display shows the final calculation: 25000 m, 20000 m, and 296.93 m<sup>2</sup>.

5

<p>0</p> 	<p>1</p> 	<p>2</p> 	<p>3</p> 	<p>4</p> 
				

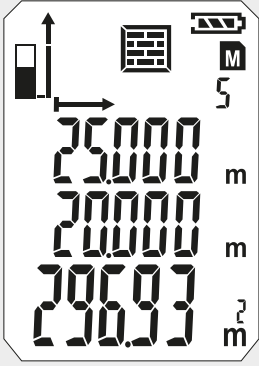

<p>5</p> 

## TIMER

With the timer, the measurement can be start delayed. For example to position a part in the measuring beam.

Push button 

- Icon is displayed.
- Timer can be set between 3 to 15 sec by pressing the button .

Push button 

- The seconds are counted down until the measurement starts.
- At 0, the measurement starts.

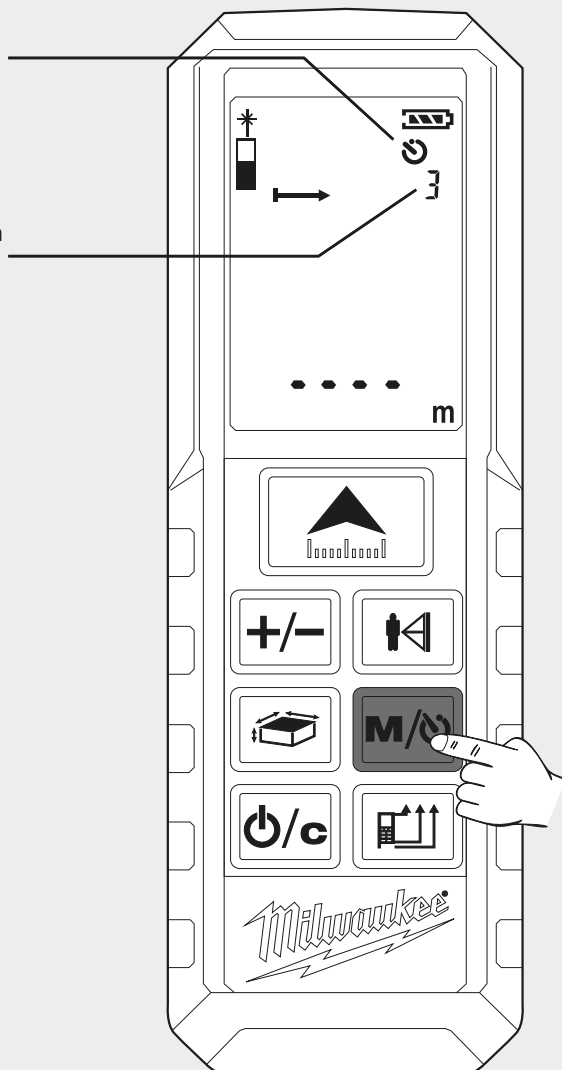

## MEMORY

The measured values are stored continuously and automatically in memory.

The stored values can be retrieved by pushing the button .

Push the button  2 sec.

- Icon and memory number appears.
- associated measured parameter is shown.
- Stored value is displayed in the main line.
- read stored values by repeated pushing the button .

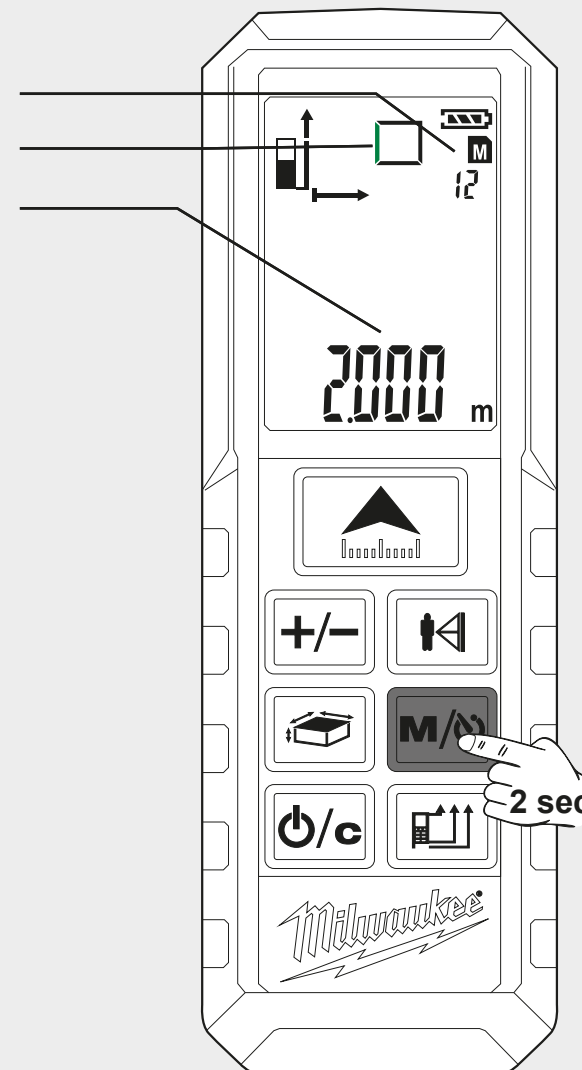



# BASIC DESCRIPTION ON EXAMPLE OF AREA MEASURING (1)

## 1 Turn On

Push Button   
**⚠ Attention! Laser on!**  
Do not point it at a person!

## 2 Choose Measuring Reference

Standard after turning on: Bottom  
 Push 1x -> Corner Pin  
Push 2x -> Top  
Push 3x -> Bottom

## 3 Choose Function

After switching on the device is always on single distance measurement  
 Push 1x - Area Measurement.

## 4 Measure length

Level the device and push button 

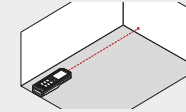

## 5 Measure width

Level the device and push button 

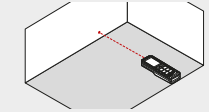

Lasericon flashes (flashing green illustrated).

Icon is displayed.

- Icon appears.  
Measured parameter flashes (flashing green illustrated)

- Measured value appears briefly in the main line.  
- Measured value jumps by 1 sec in line above.

- Measured value appears briefly in the base line.  
- Measured value jumps by 1 sec in line above.

Measured value is stored in memory at consecutive numbers.  
Second measured parameter flashes.  
Device ready for measurement of the second value.

Measured value is stored in memory at consecutive numbers.  
- Result is displayed in the main line and stored in memory at consecutive numbers.

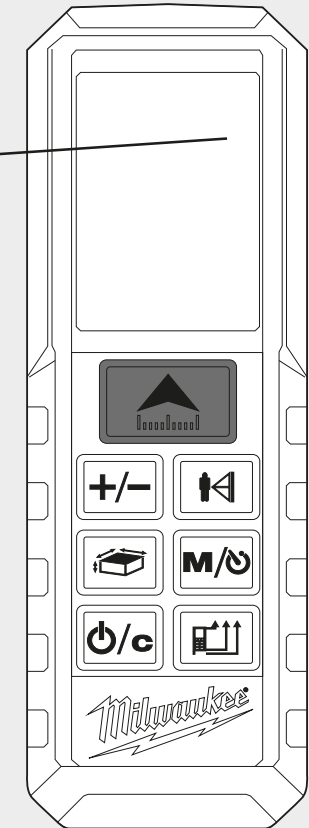
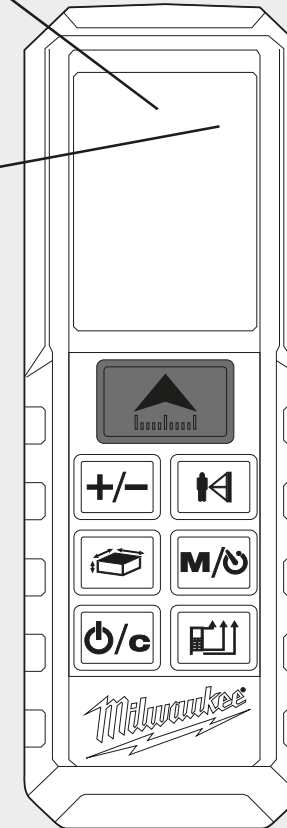
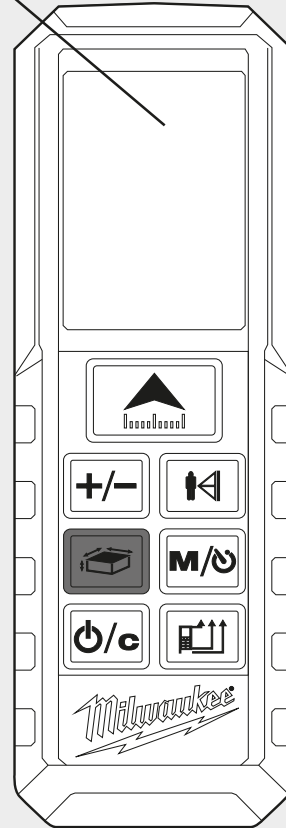
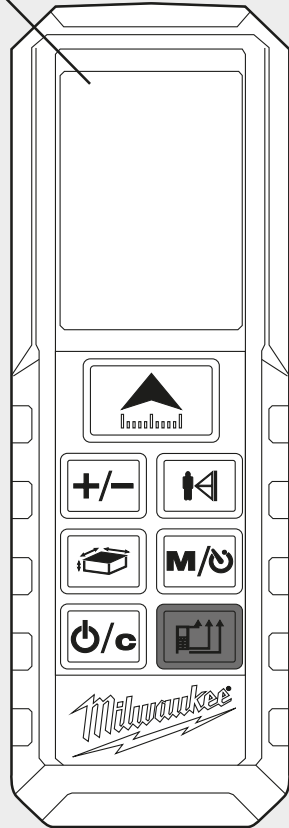
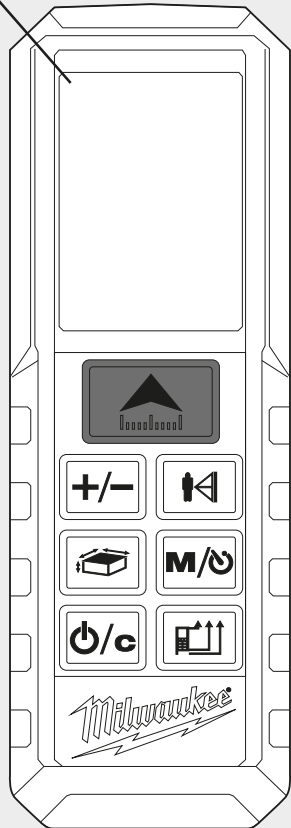

## 6 View stored values

Push button **M/0** 2 sec.  
Push button **M/0** repeated

## 7 Exit memory

Push button **0/c**.

## 8 Switch off

Push button **0/c** 2 sec  
(Memory must be exited before)

- Stored values appears in the main line.

Associated icon appears and measured parameter flashes (flashing green illustrated)

- Device switches off.

- If no button is pressed, the device switches off automatically after 3 minutes.

