

**LEGO**

# МІНІЖАГО

7112

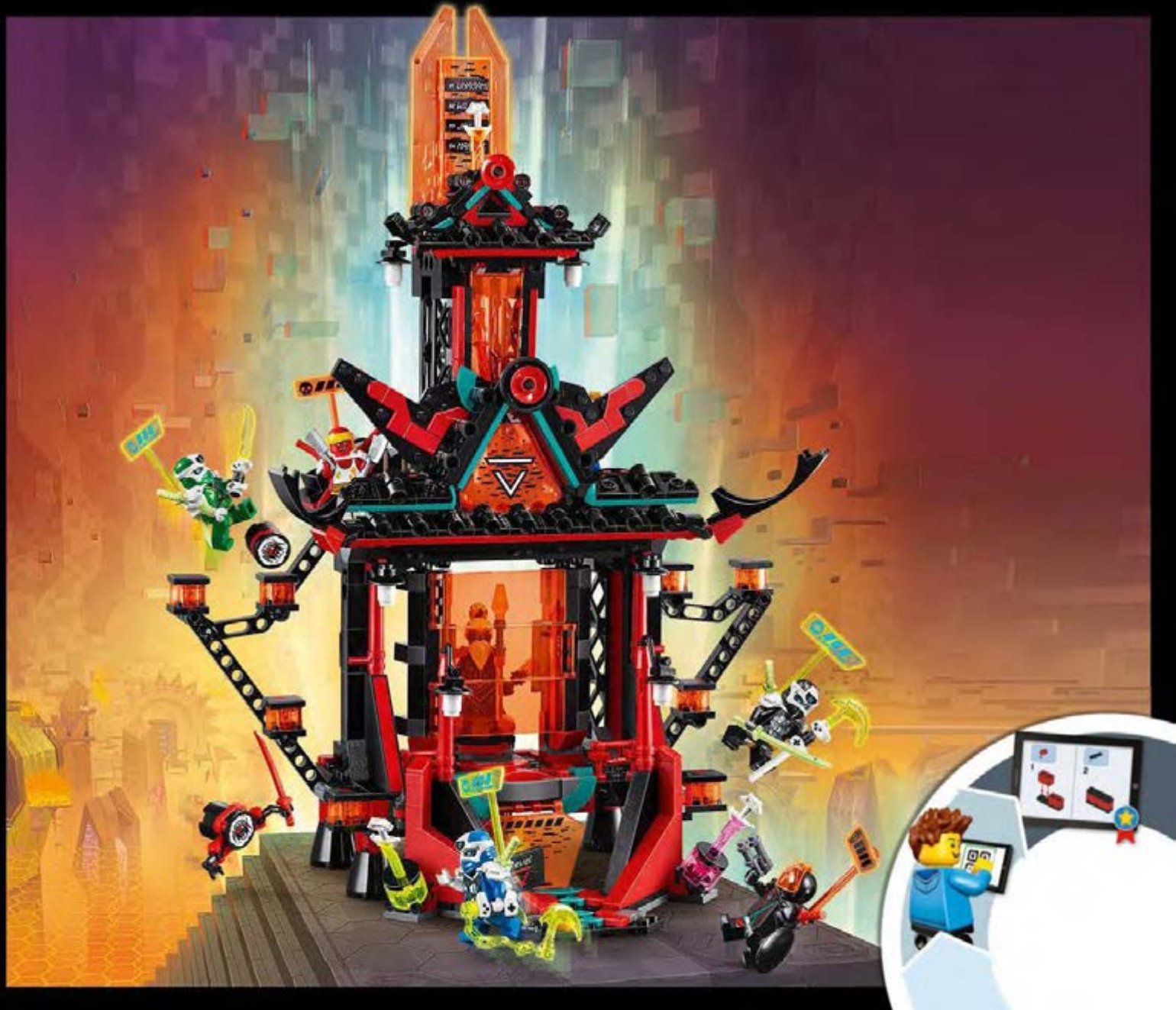

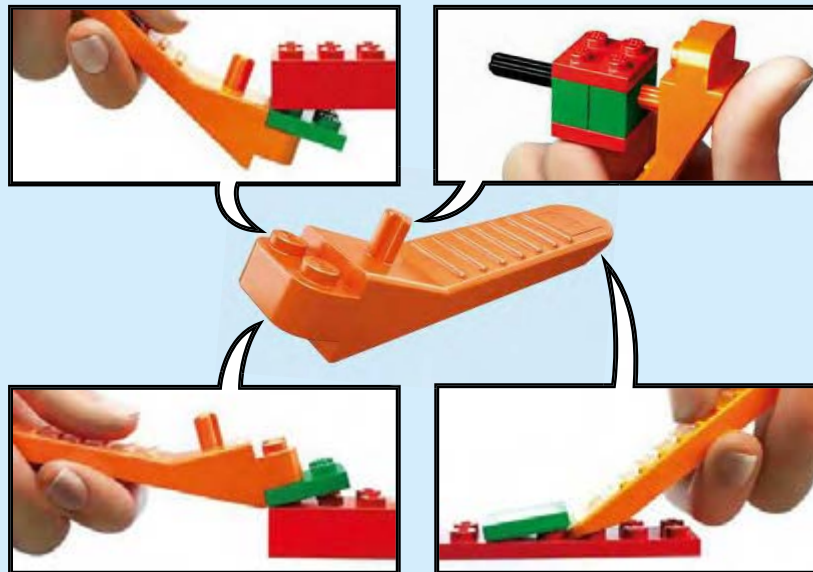

[LEGO.com/brickseparator](https://lego.com/brickseparator)



- 1** Scan the code on the front cover  
 Scanne den Code auf der Titelseite  
 Scanne le code sur la page de couverture  
 Scanner le code sur la page couverture  
 Scansiona il codice sulla copertina  
 Escanea el código de la portada  
 Faz scan do código na frente da capa  
 Olvasd be a borítón látható kódot!  
 Noskenē kodu uz priekšējā vāka  
 扫描封面上的二维码



- 2** Get the Building Instructions  
 Hol dir die Bauanleitung  
 Obtens les instructions de montage  
 Obtenir les instructions de montage  
 Scarica le istruzioni per la costruzione  
 Consulta las instrucciones de construcción  
 Obtém as Instruções de Construção  
 Szerezd be az építési útmutatókat!  
 Saņem būvēšanas instrukcijas  
 获取拼搭说明

**LEGO.com/apps**

Check for compatibility  
 Kompatibilität prüfen  
 Vérifier la compatibilité  
 Controlla la compatibilità  
 Comprueba tu compatibilidad

Verificar a compatibilidade  
 Ellenőrizd a kompatibilitást  
 Pārbaudīt saderību  
 检查兼容性



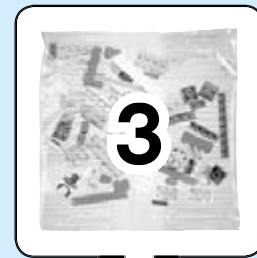
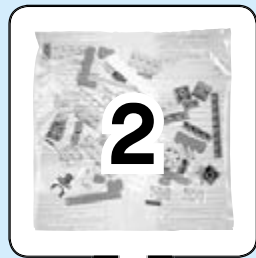



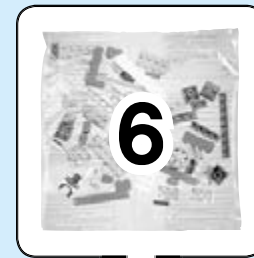



1









1



2

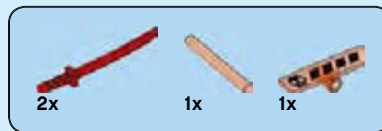
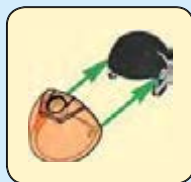

3

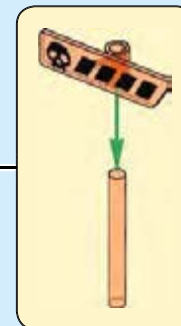

4



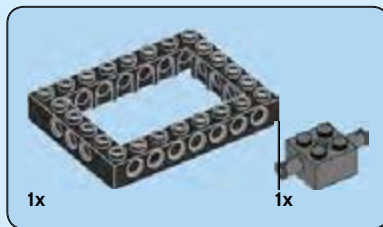
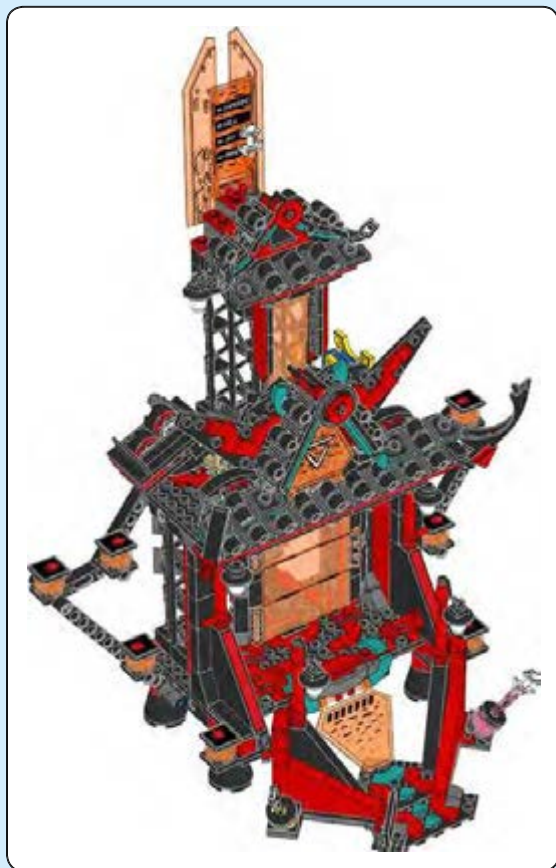

1

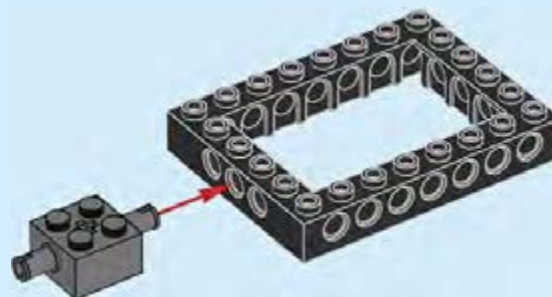

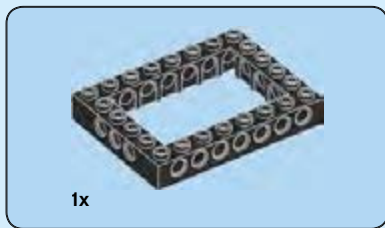

2

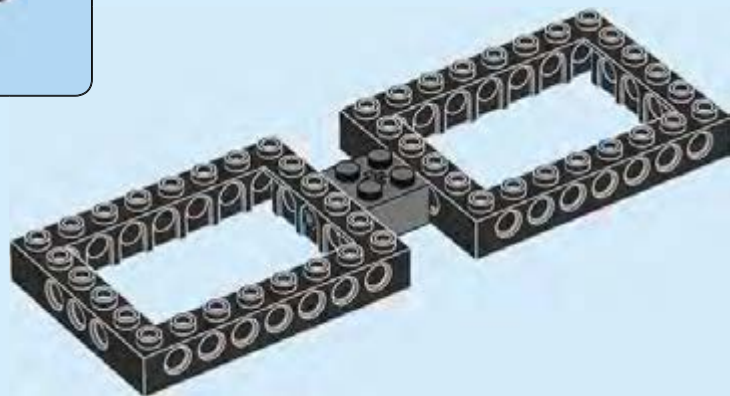

3

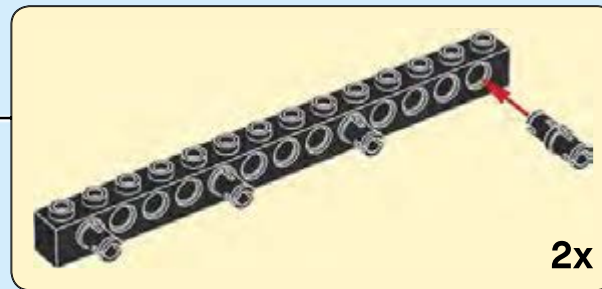
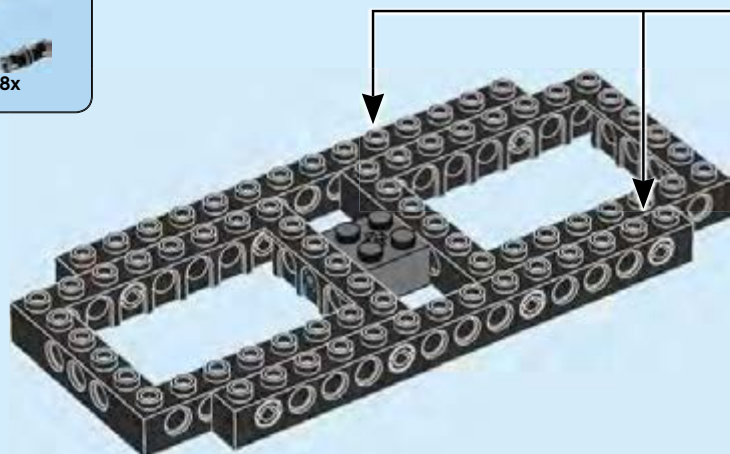





4

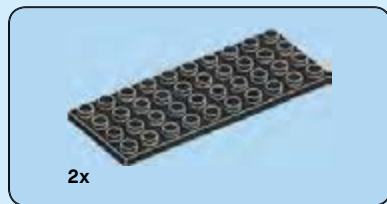
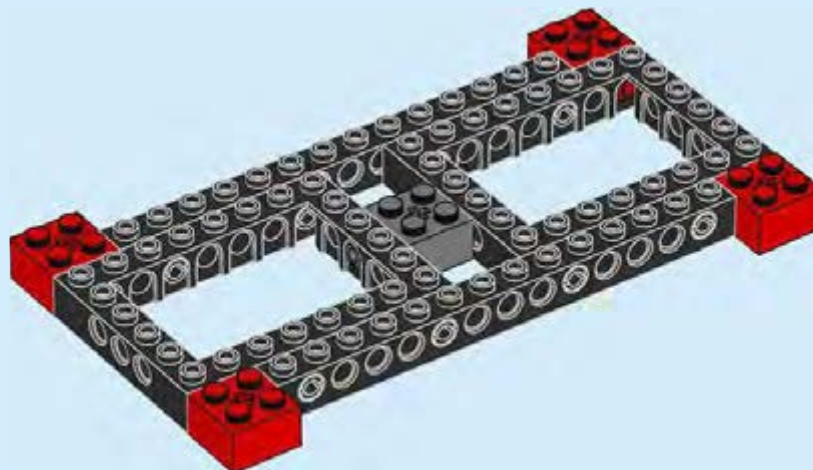

5

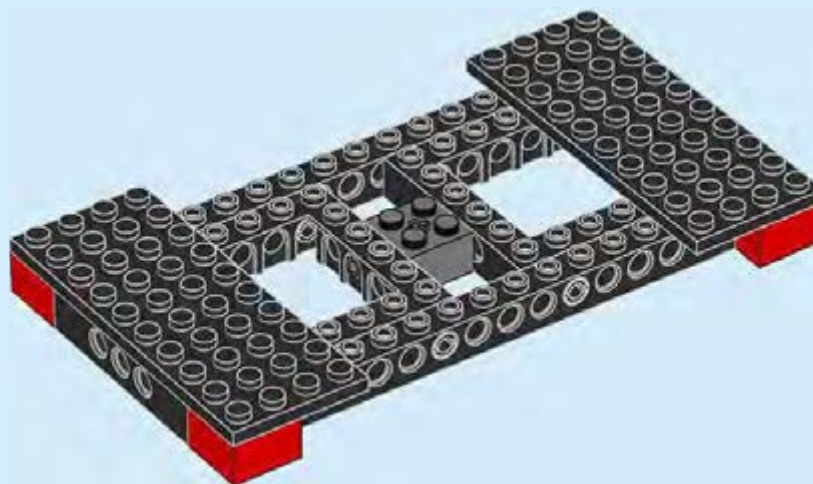

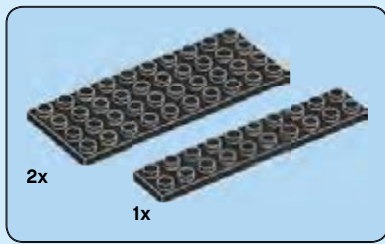

6

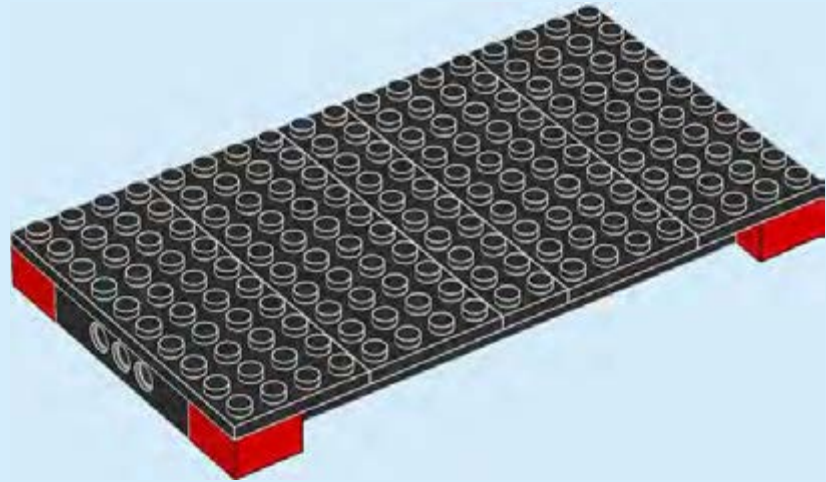

7

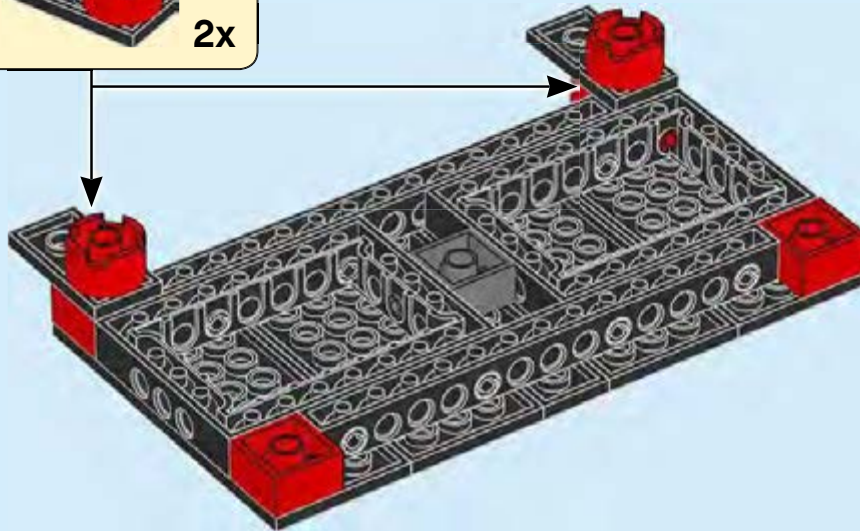

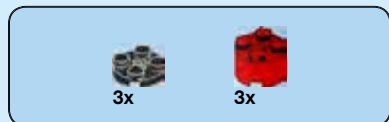

8

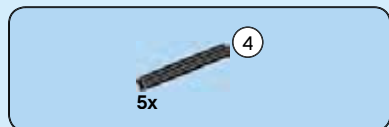
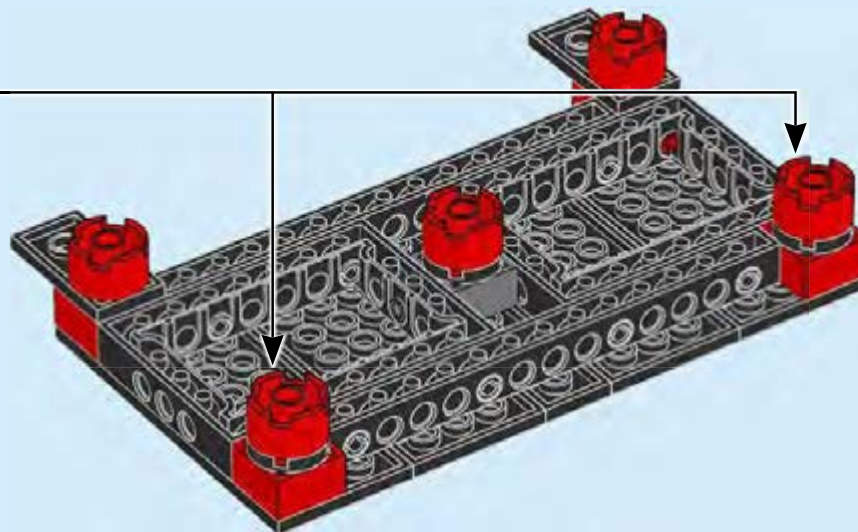
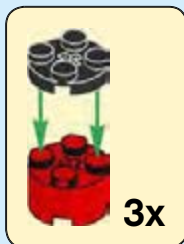

9

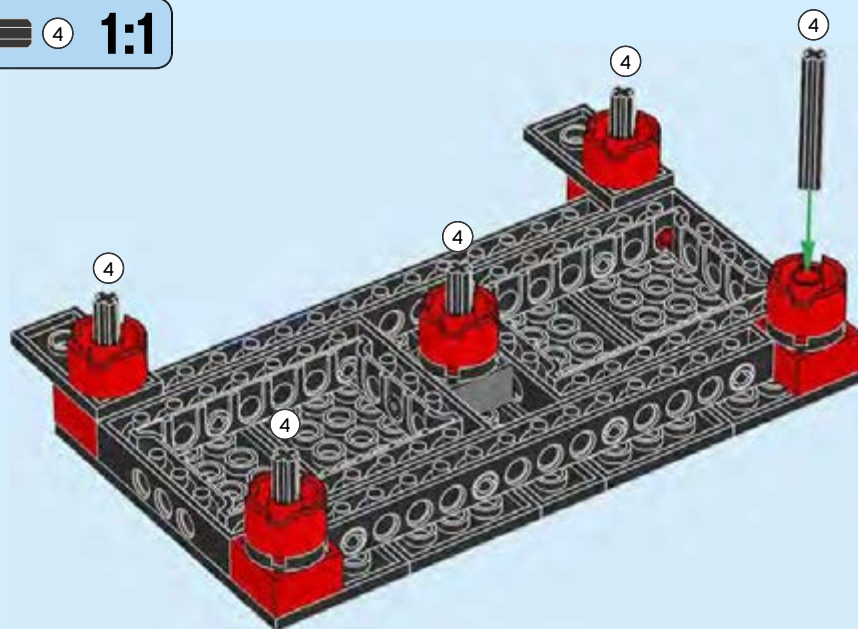



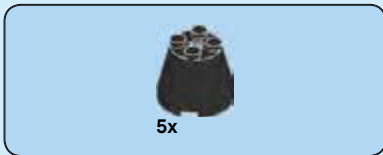

10

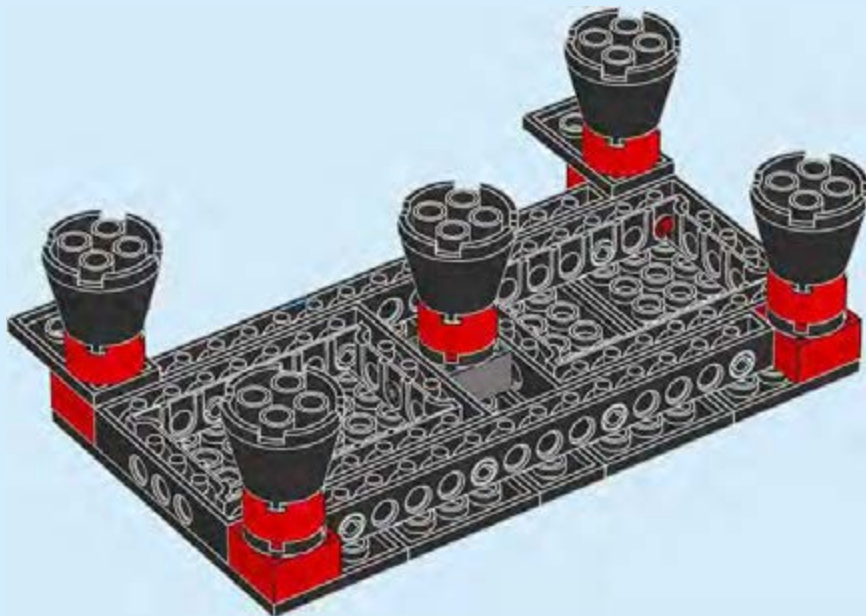

11

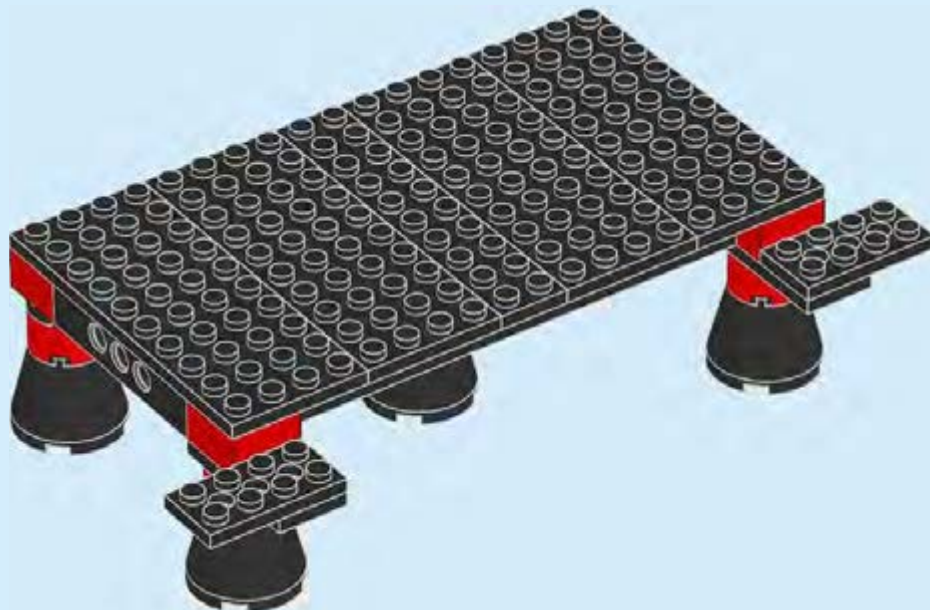

14



12

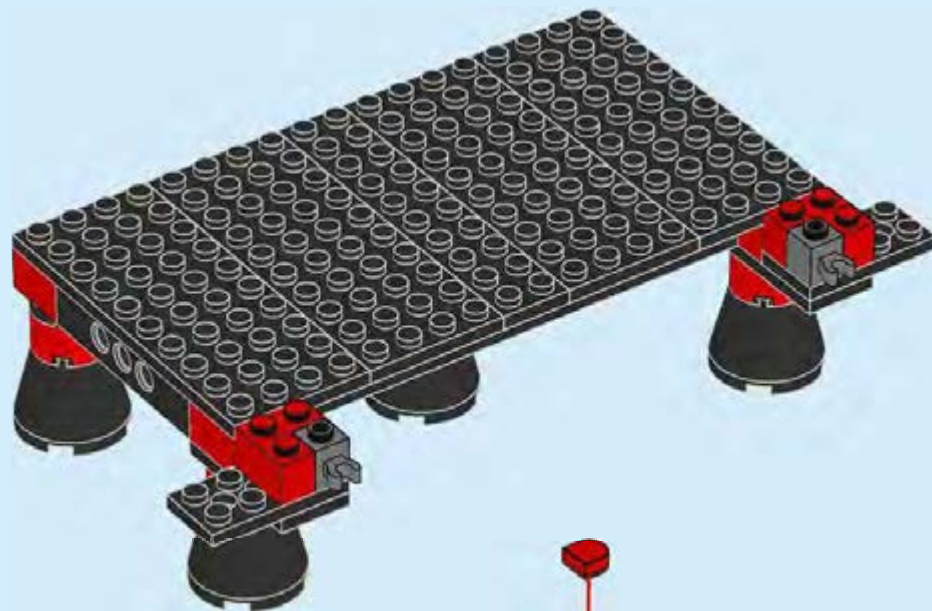

13

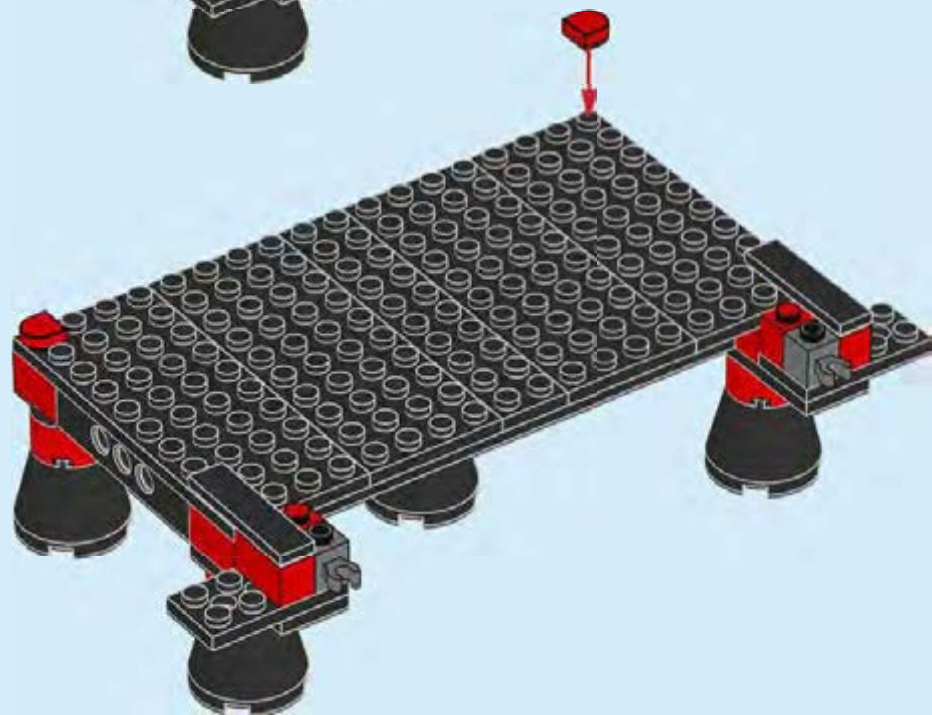

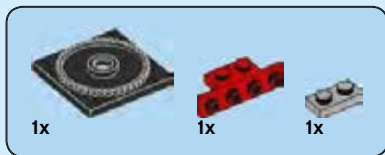

14

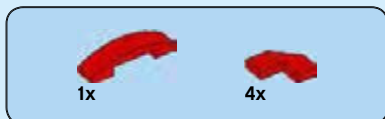
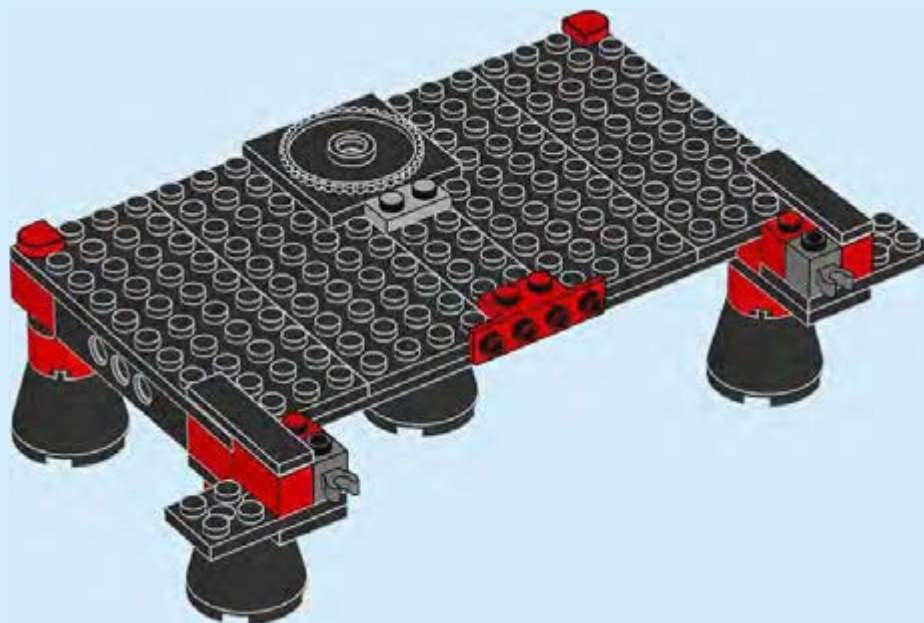

15

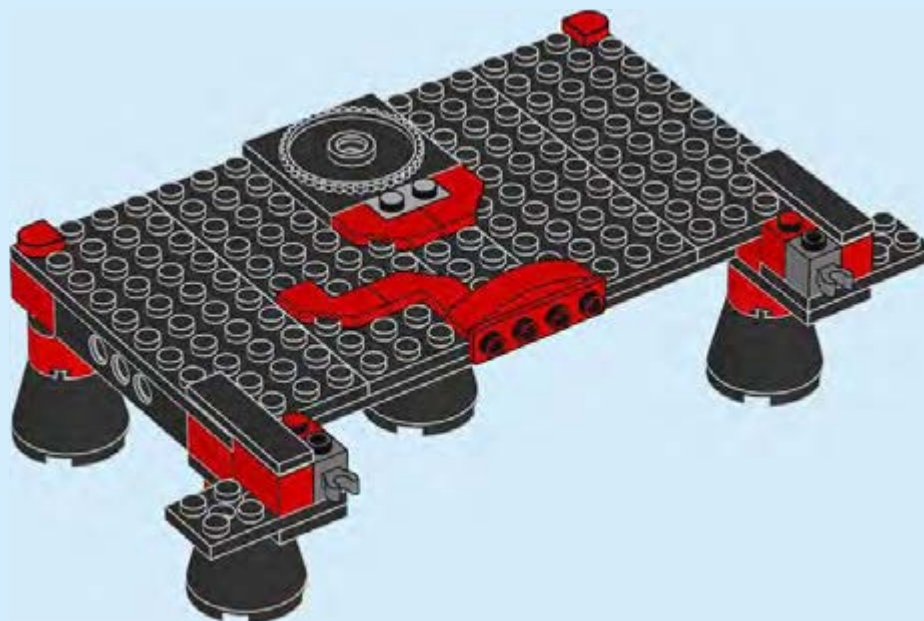

16





16



17

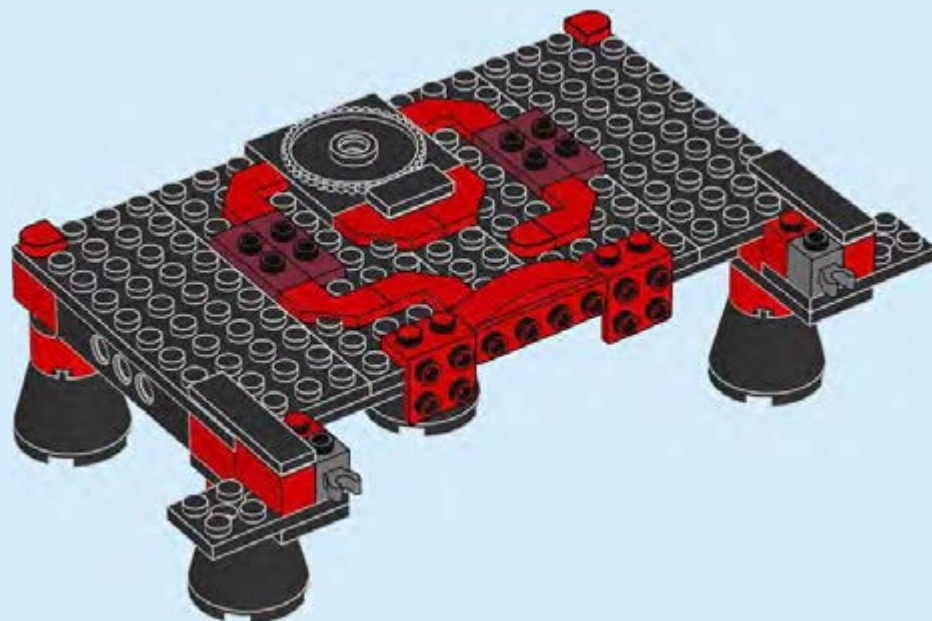



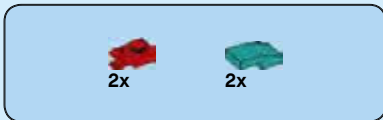

18

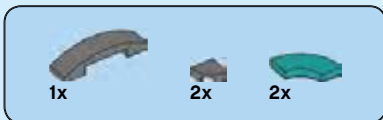
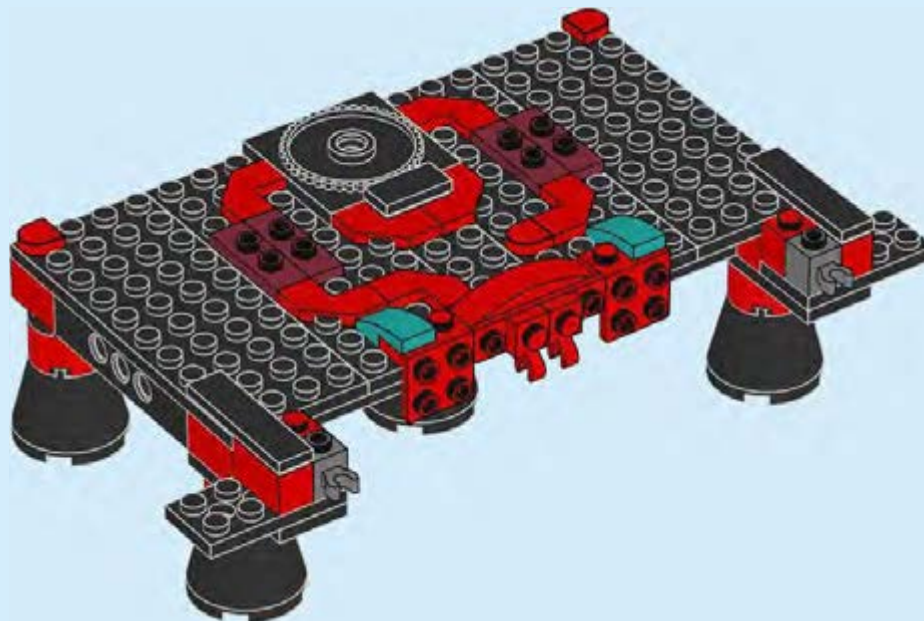

19

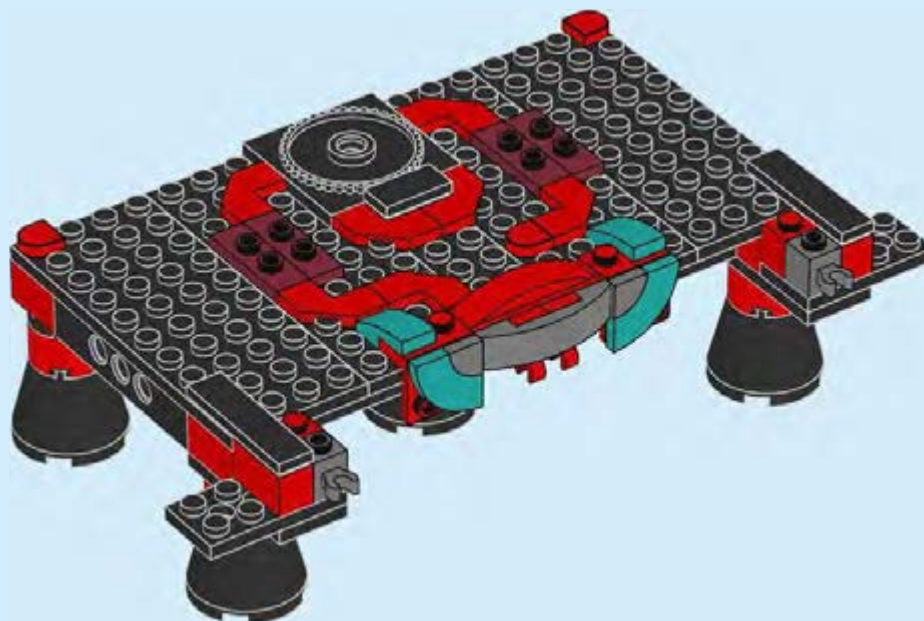

18



20

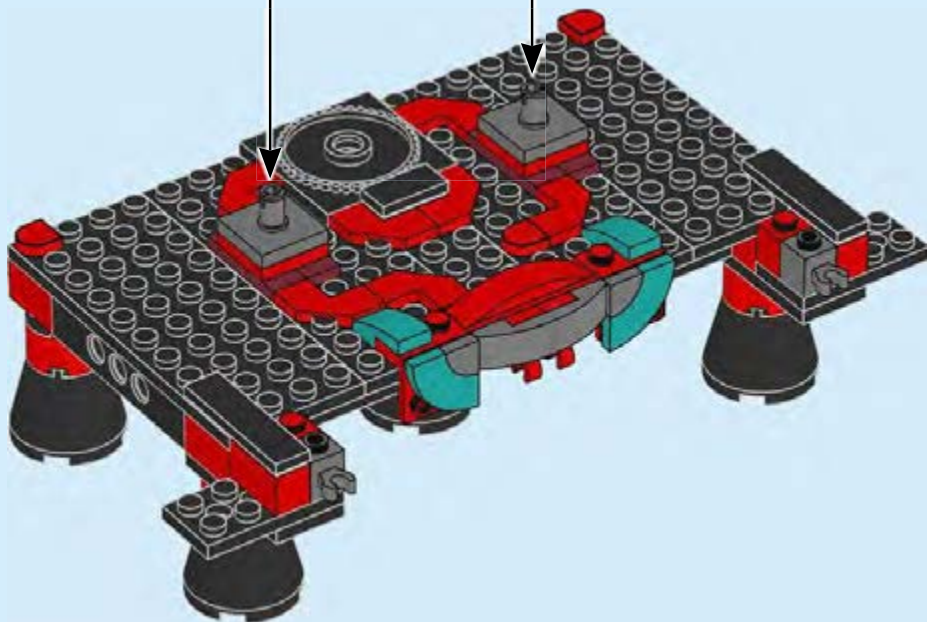

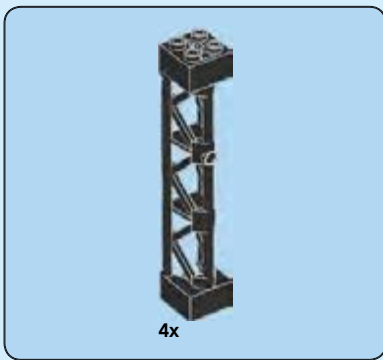

21

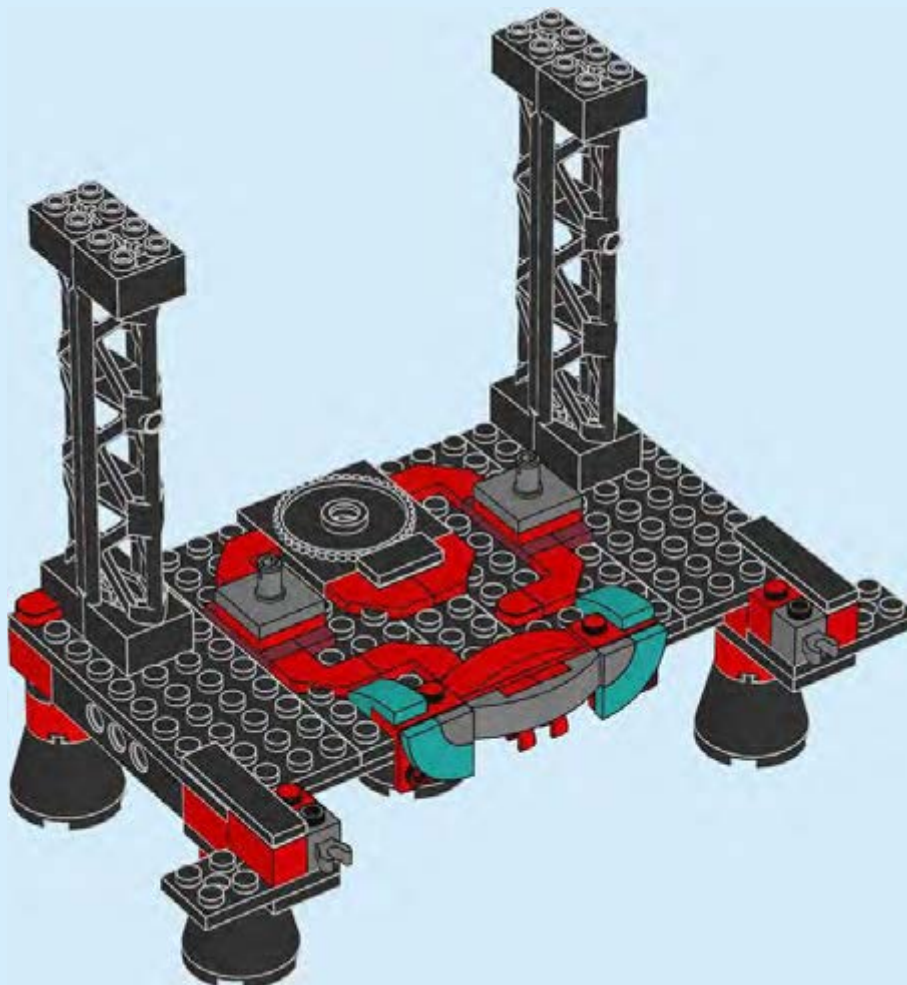

20



22

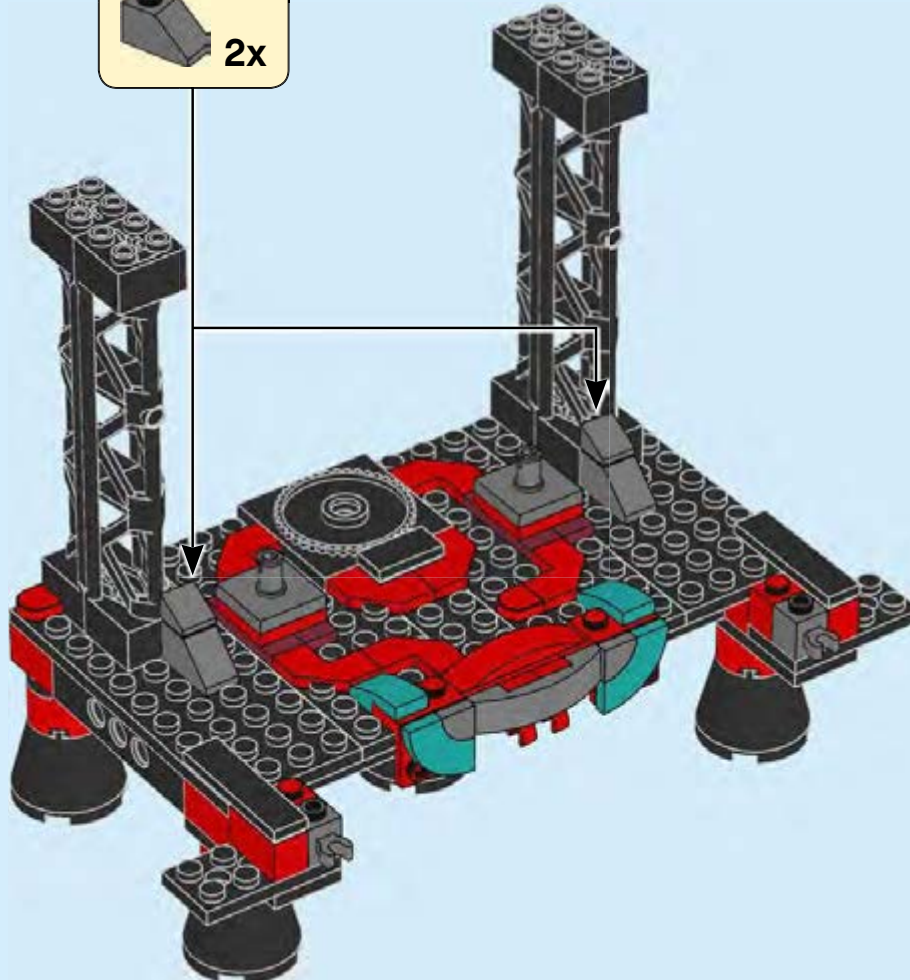
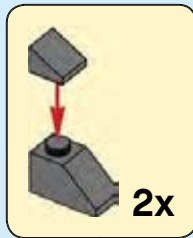





23

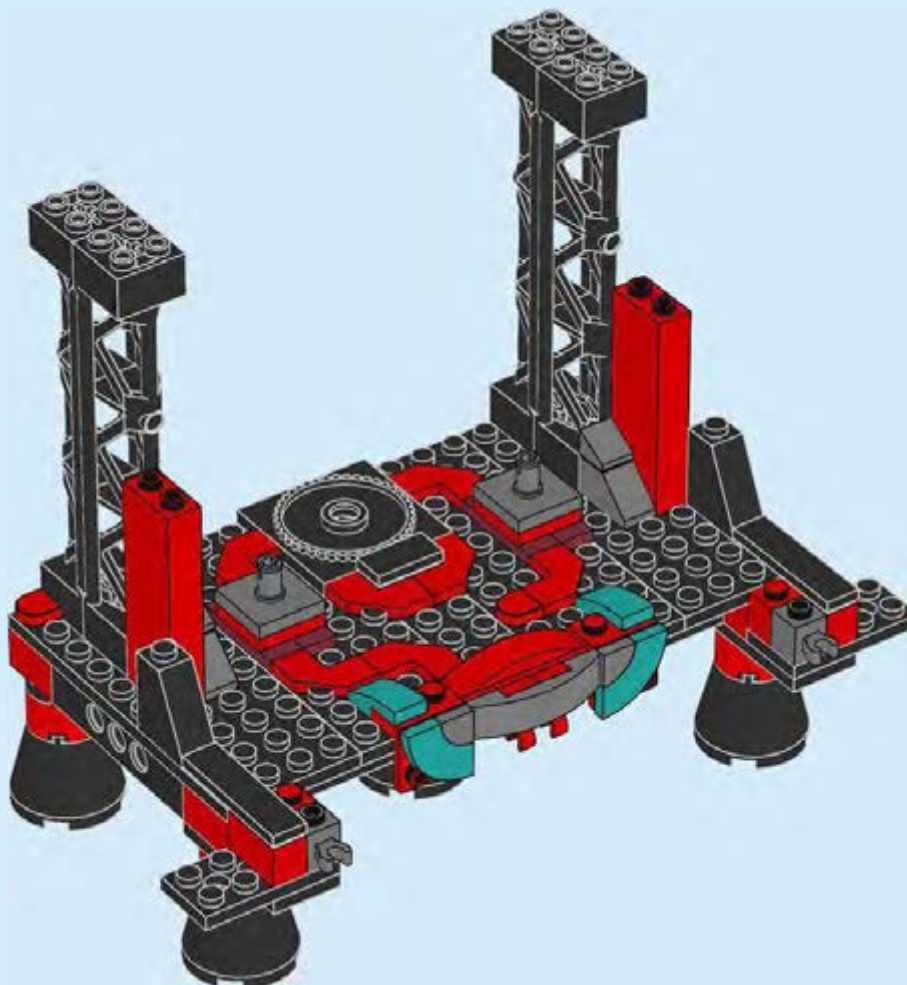

22

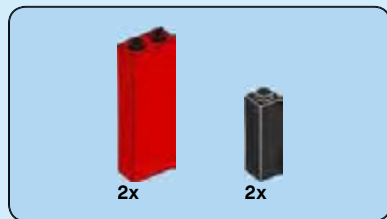

24

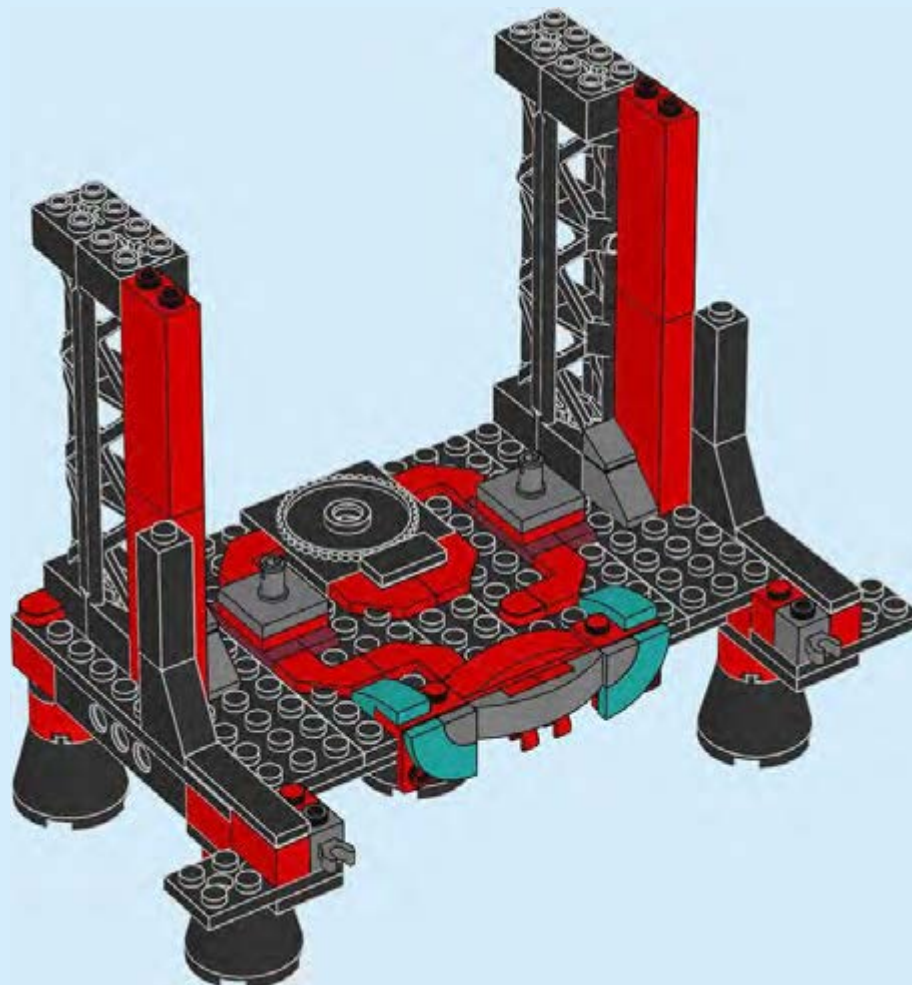



25

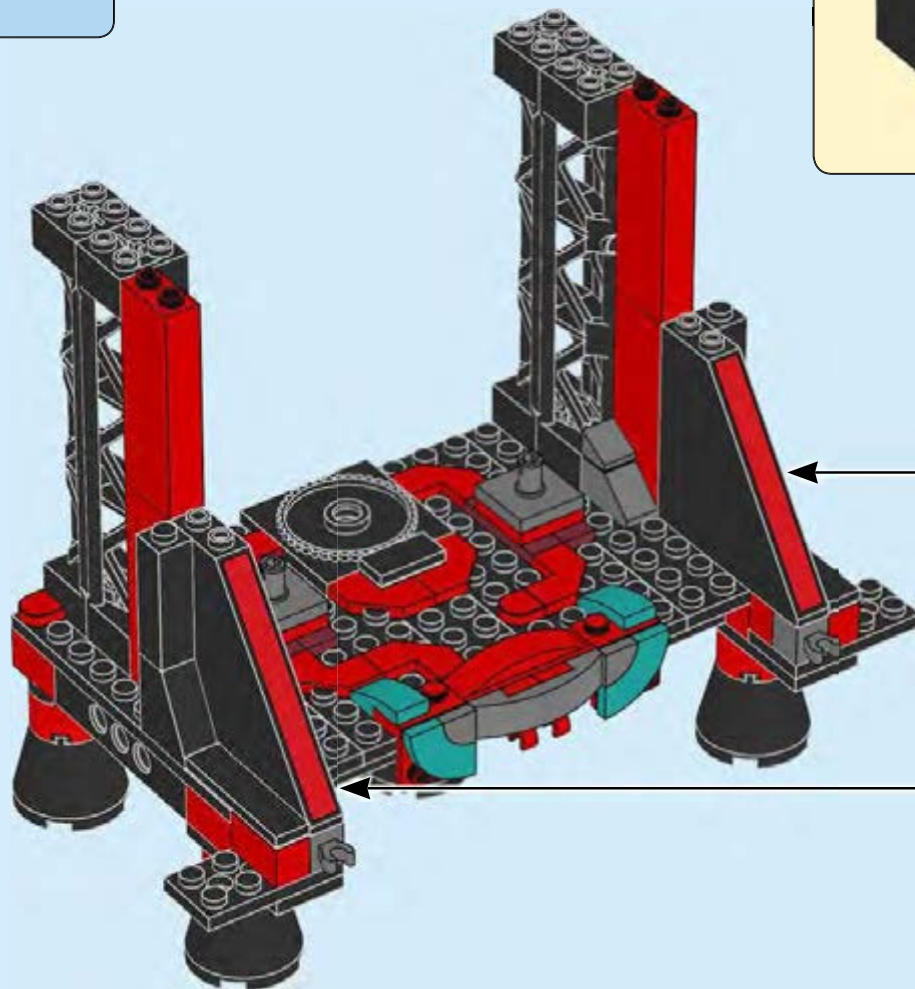
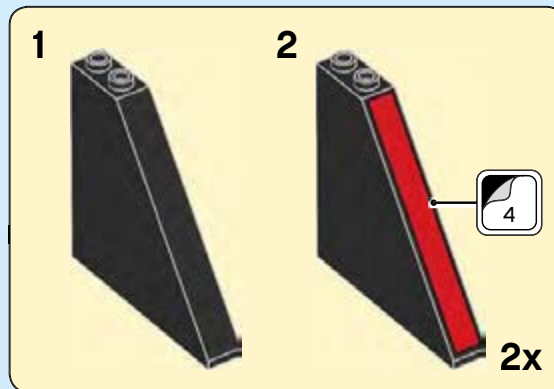

24



26

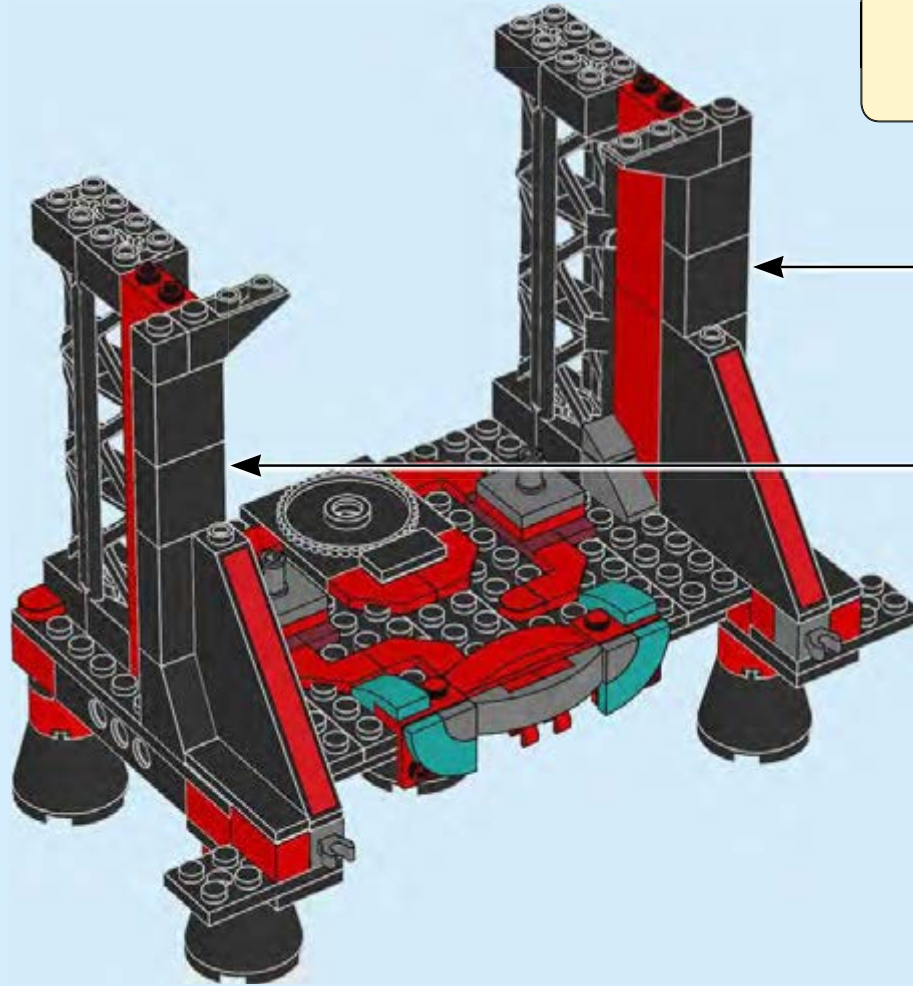
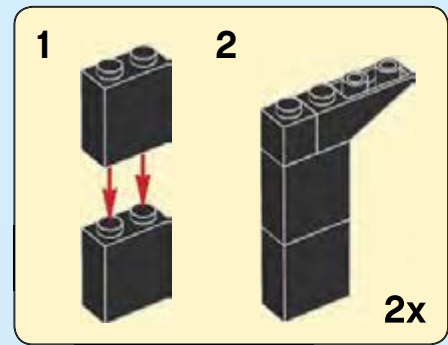



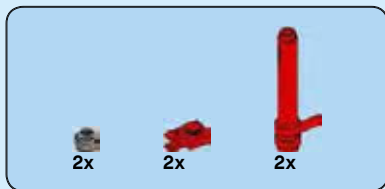

27

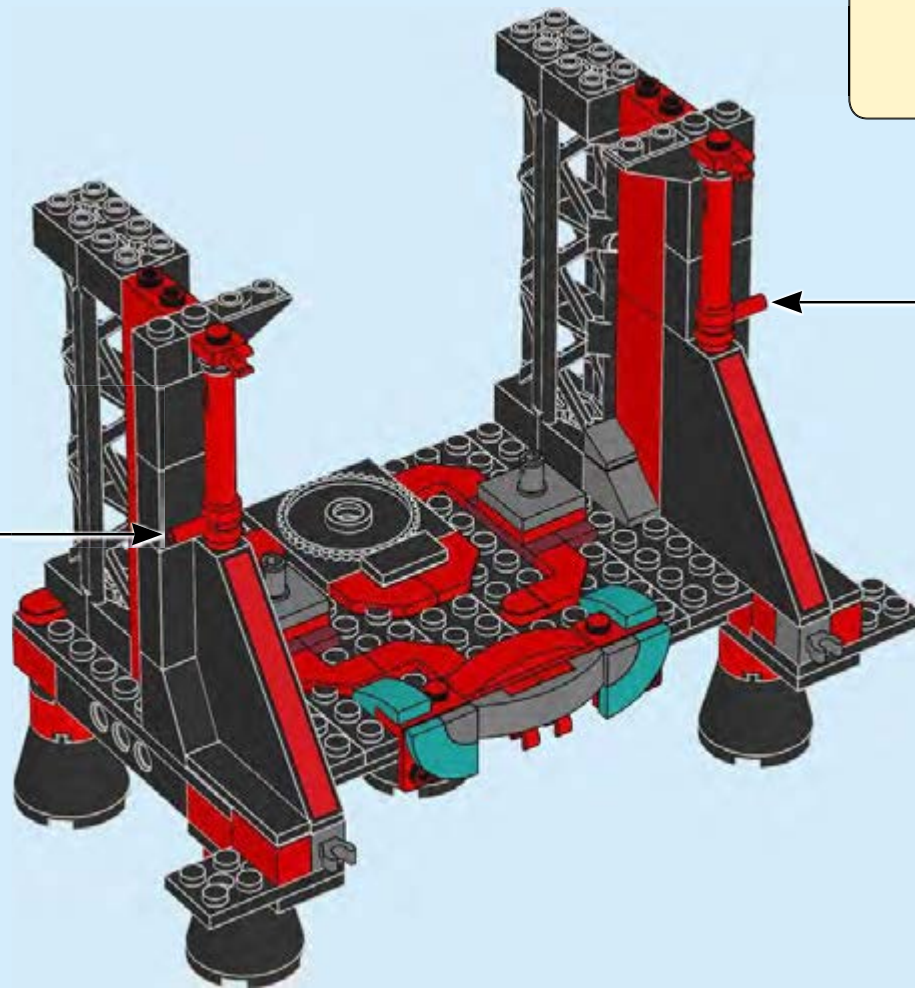
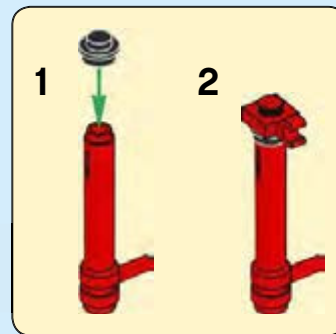
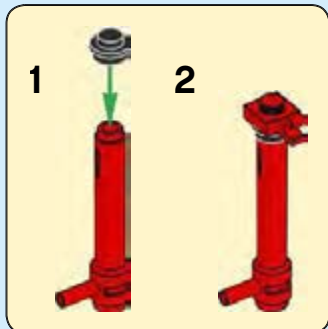

26



28

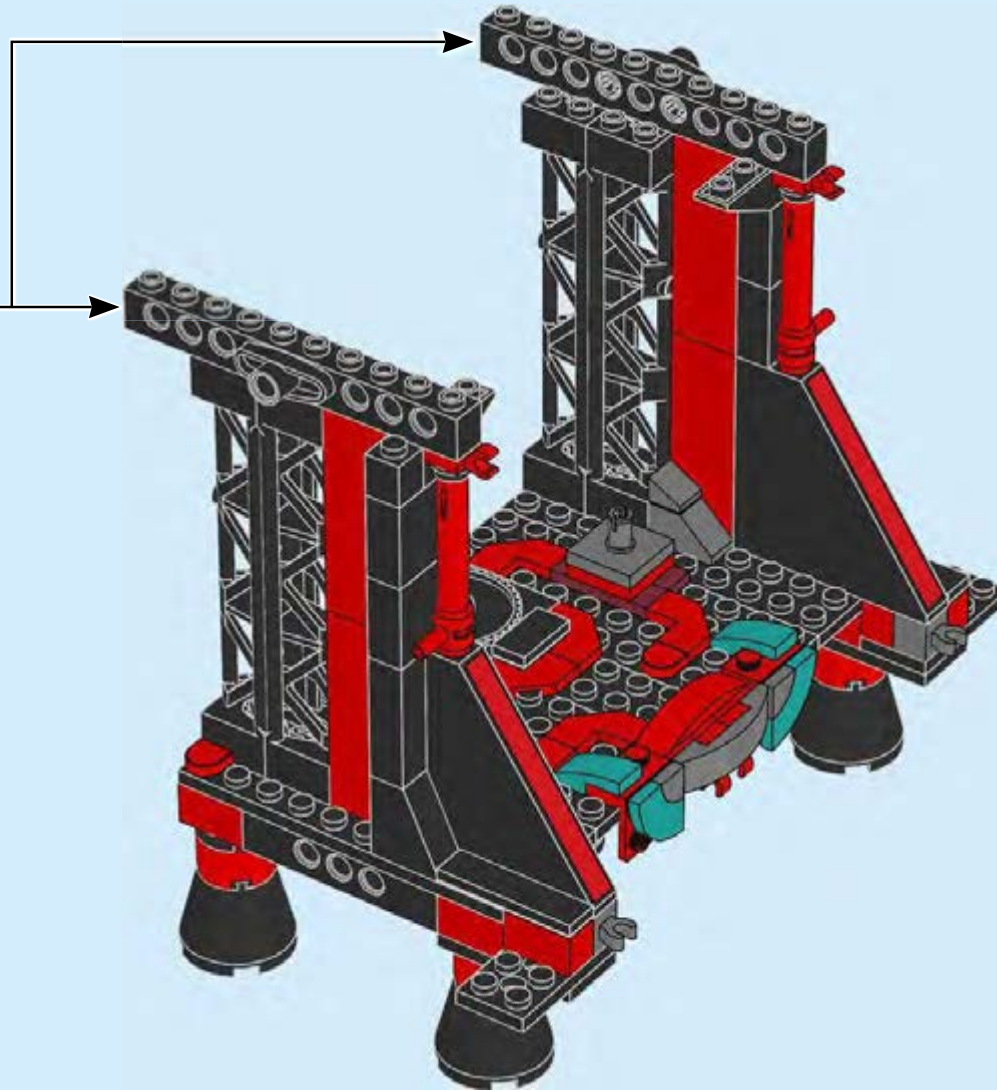
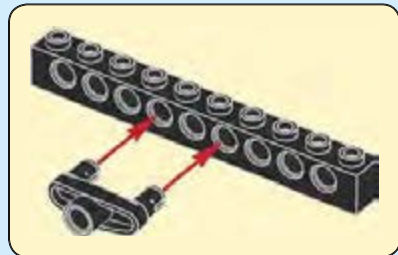



29

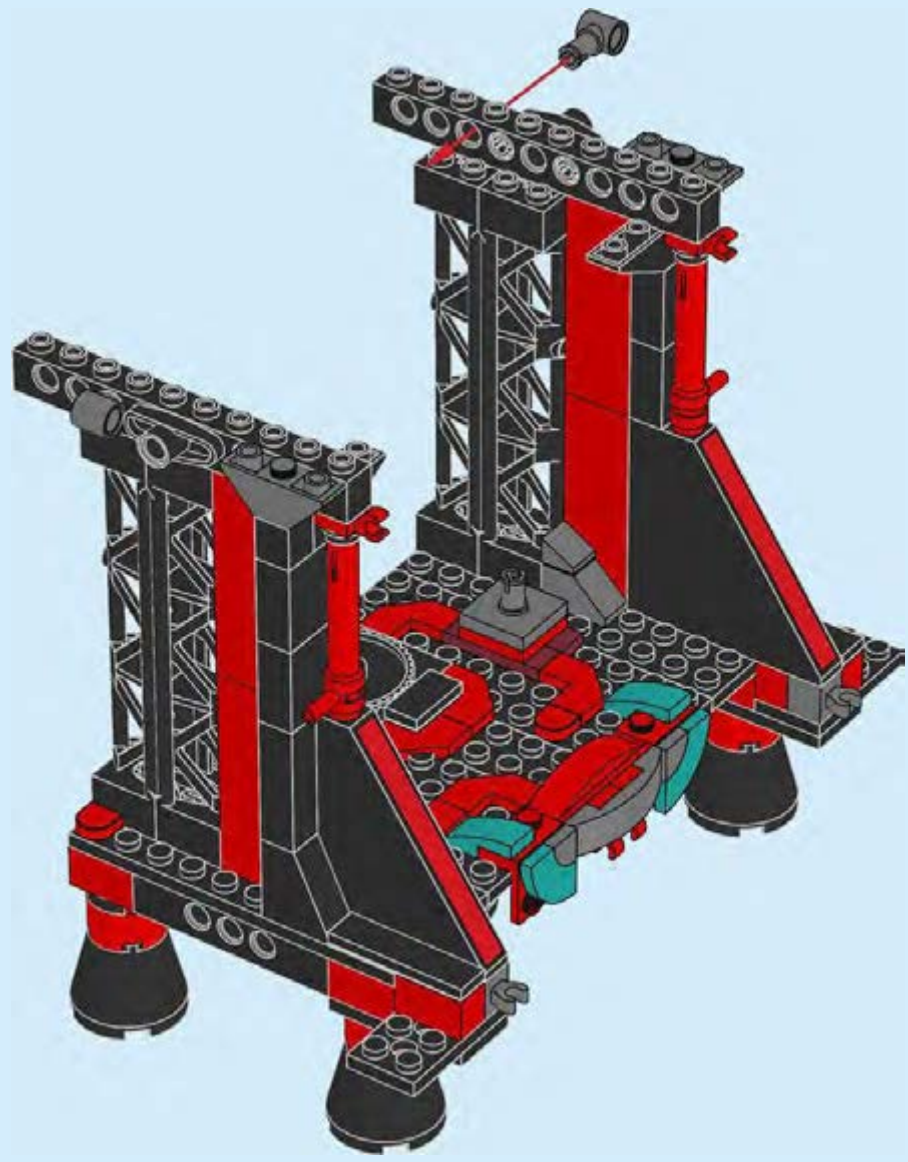

28

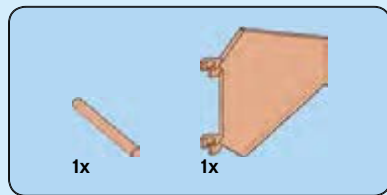

30

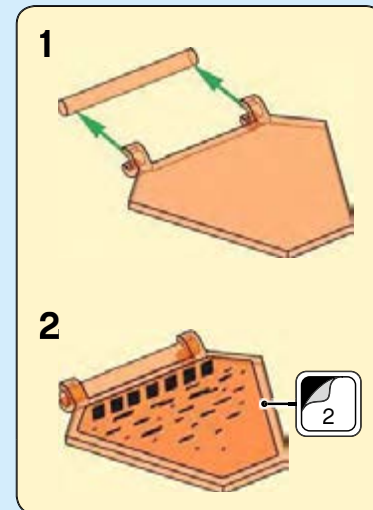
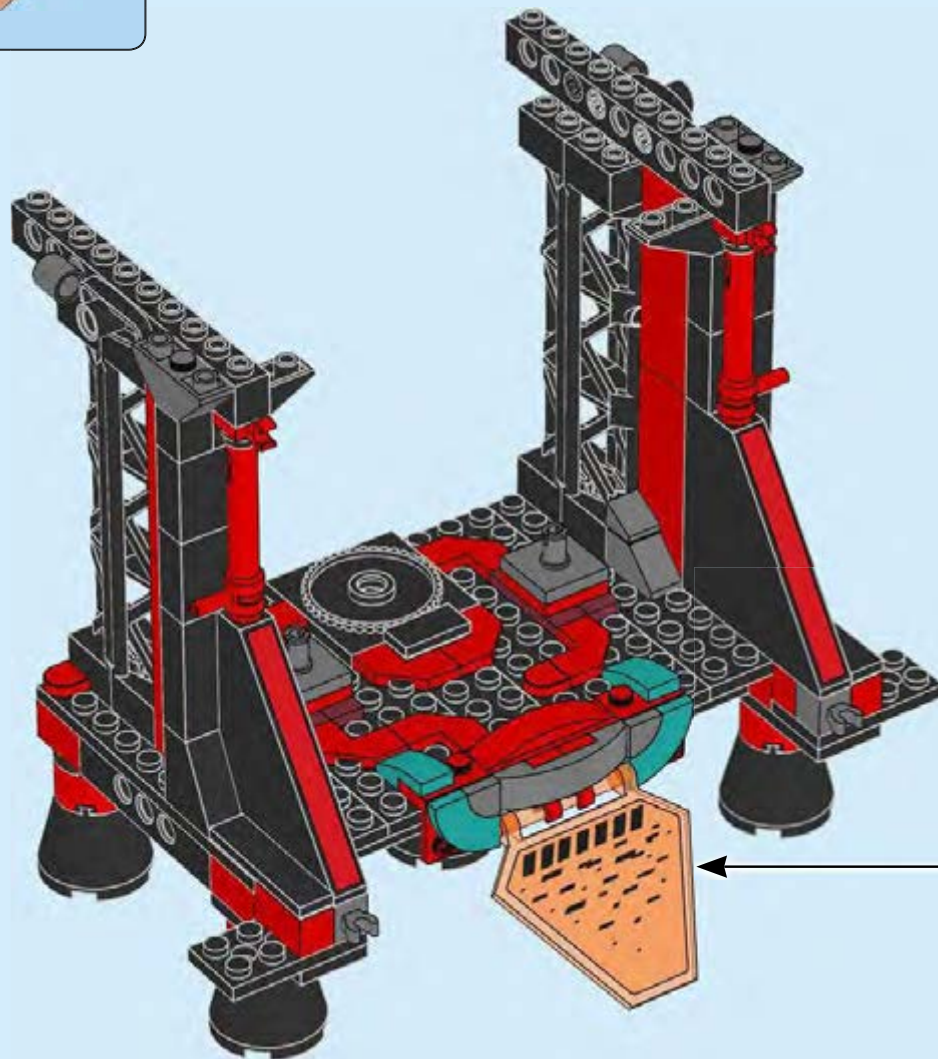





1



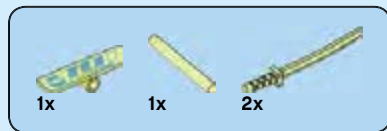

2

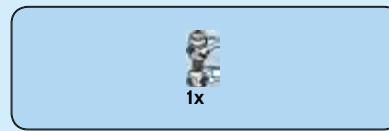
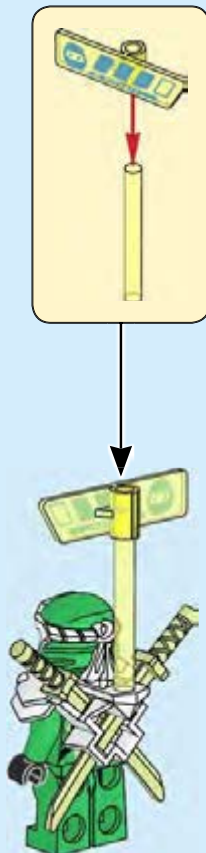

3

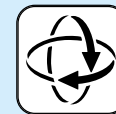
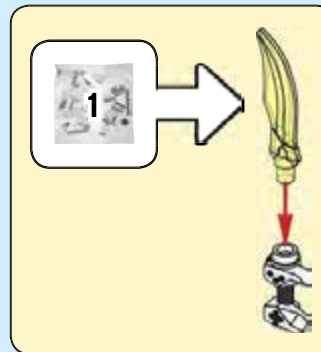



4x



4x

31

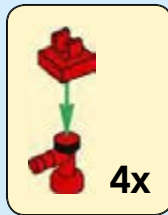

4x

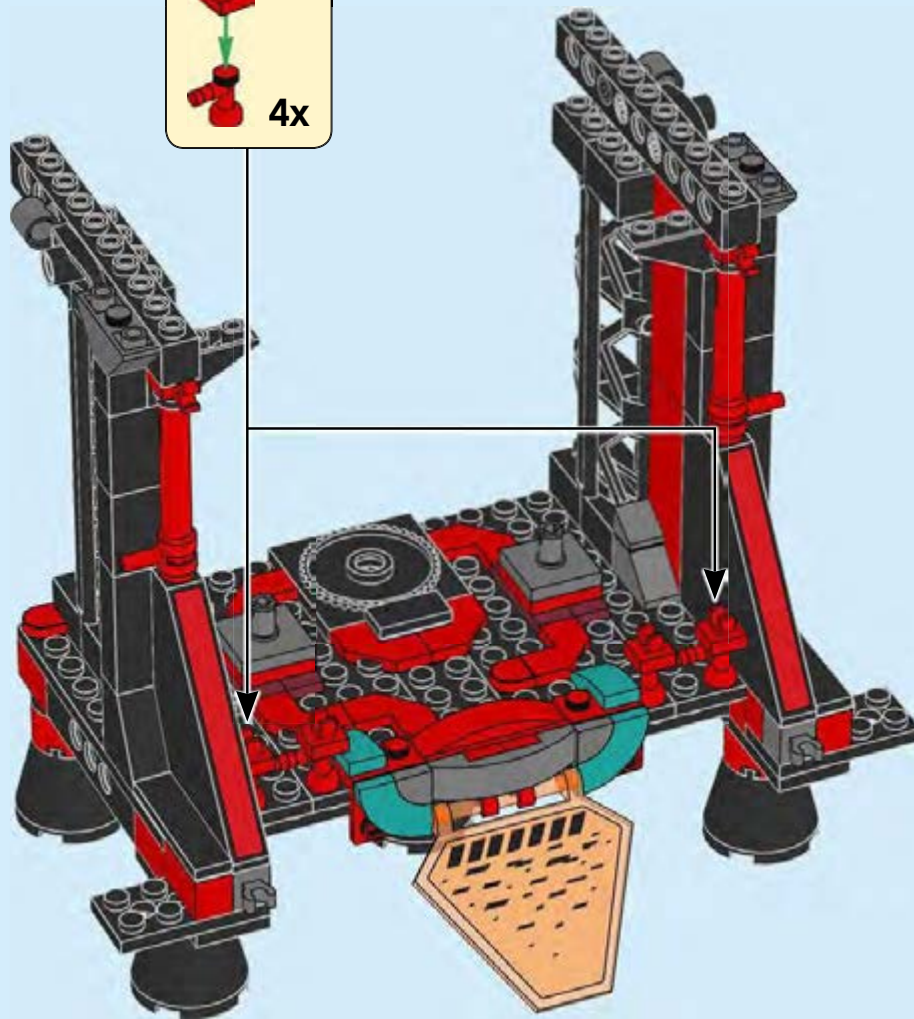

32

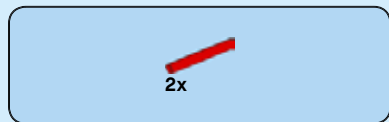

32

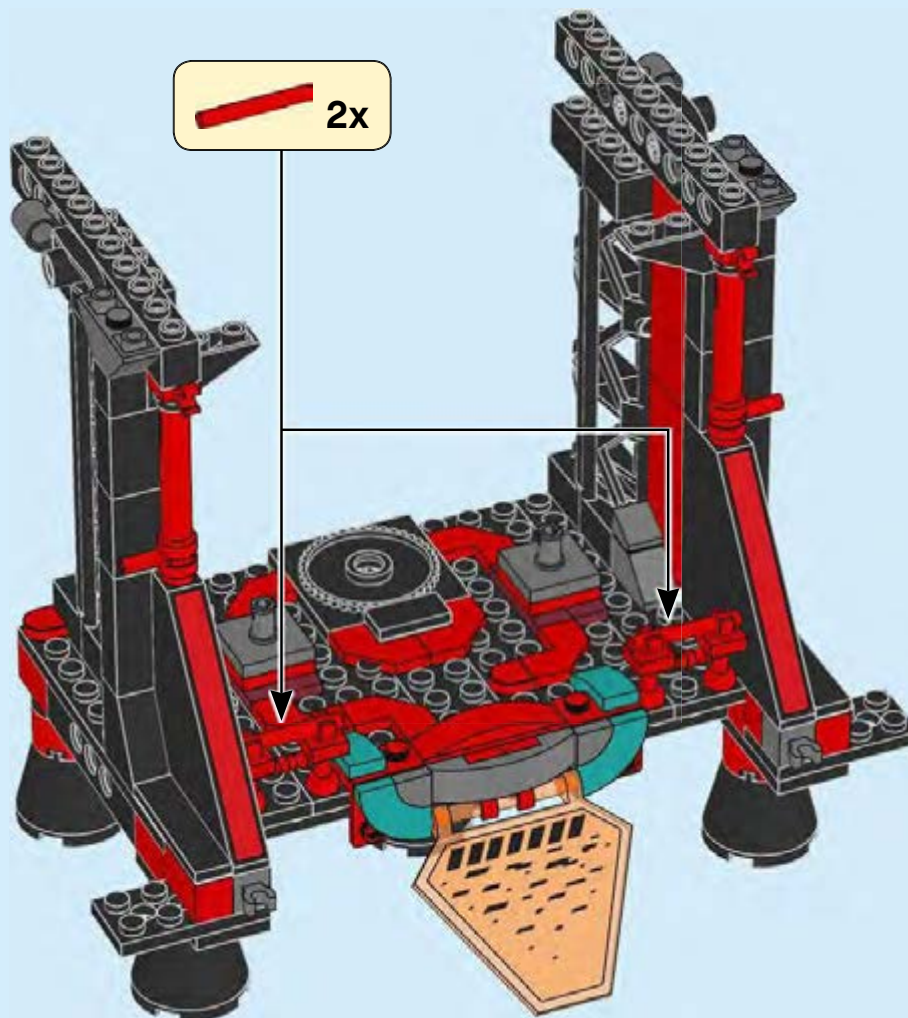



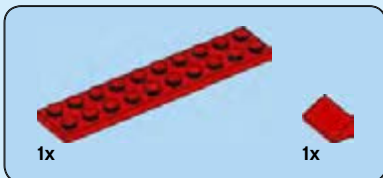

33

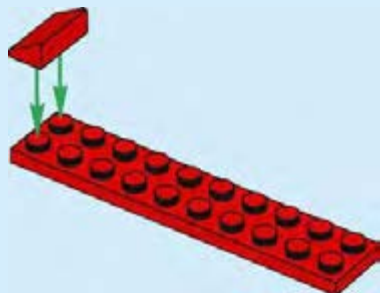

34



34

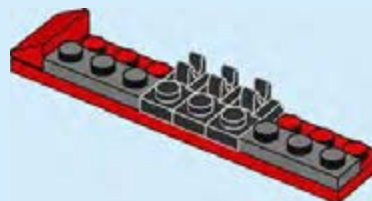

35

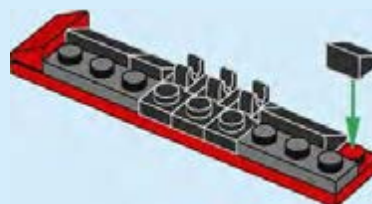



36

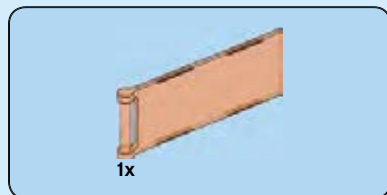
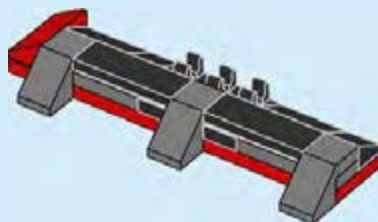

37

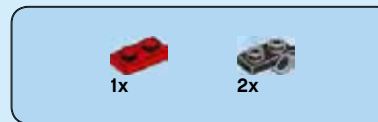
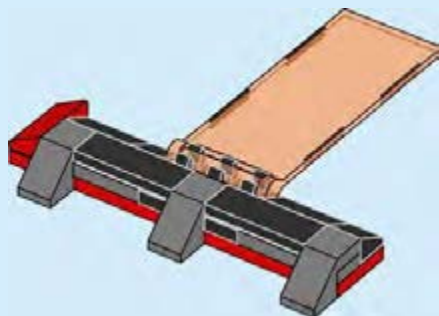

38

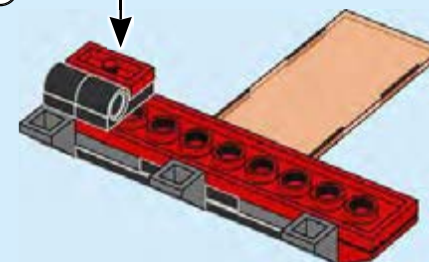
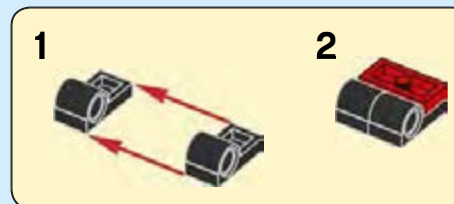

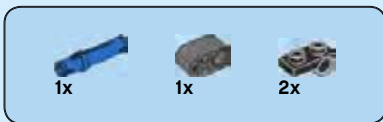

39

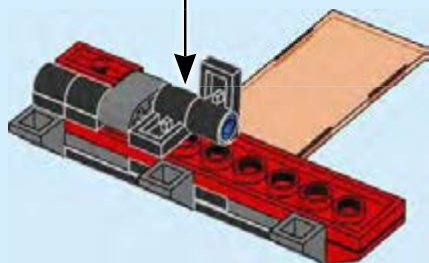

36

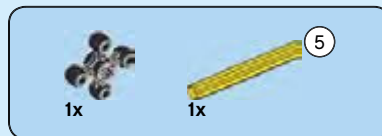

40

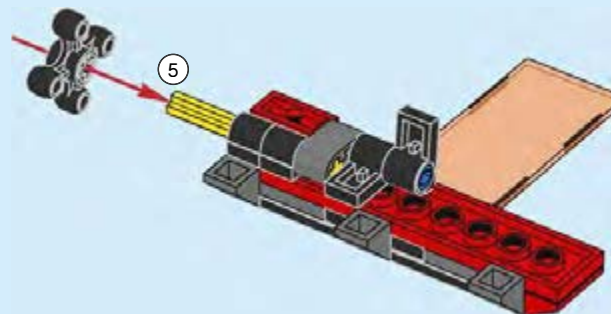

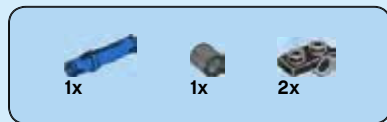

41

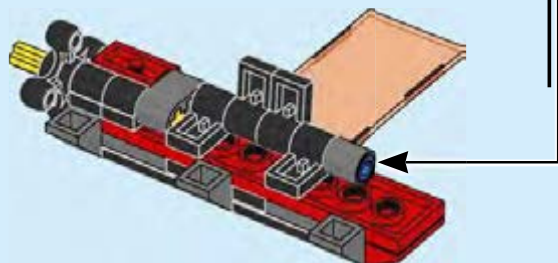

42

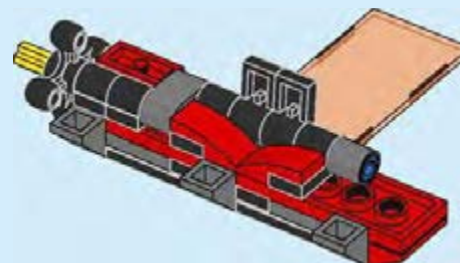



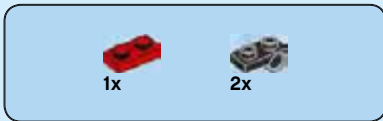

43

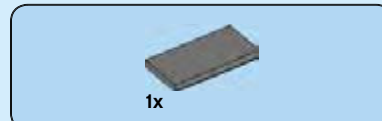
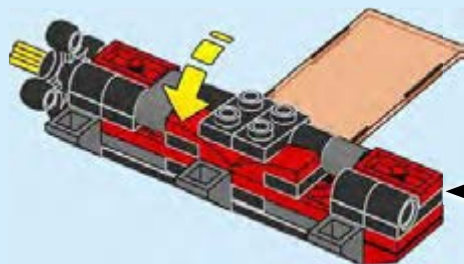
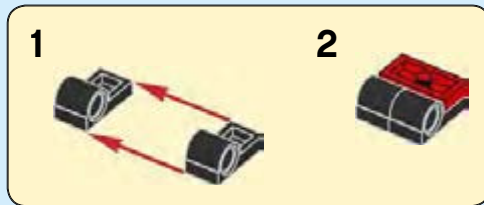

44

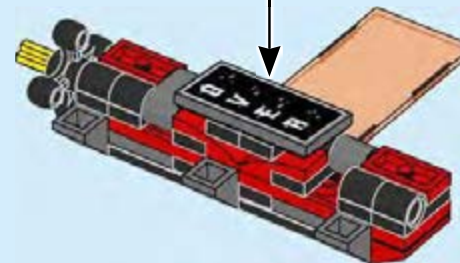
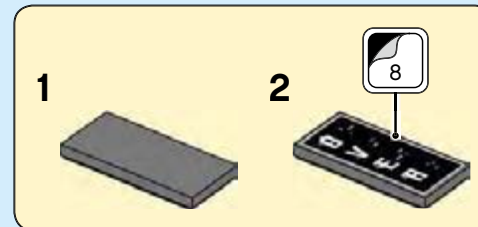

45

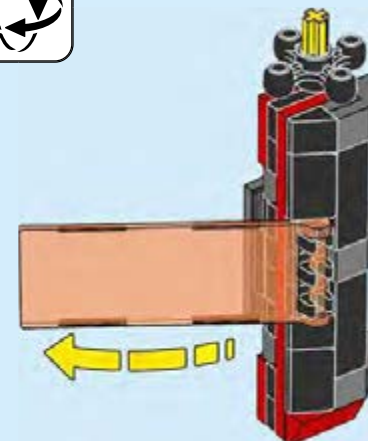

46

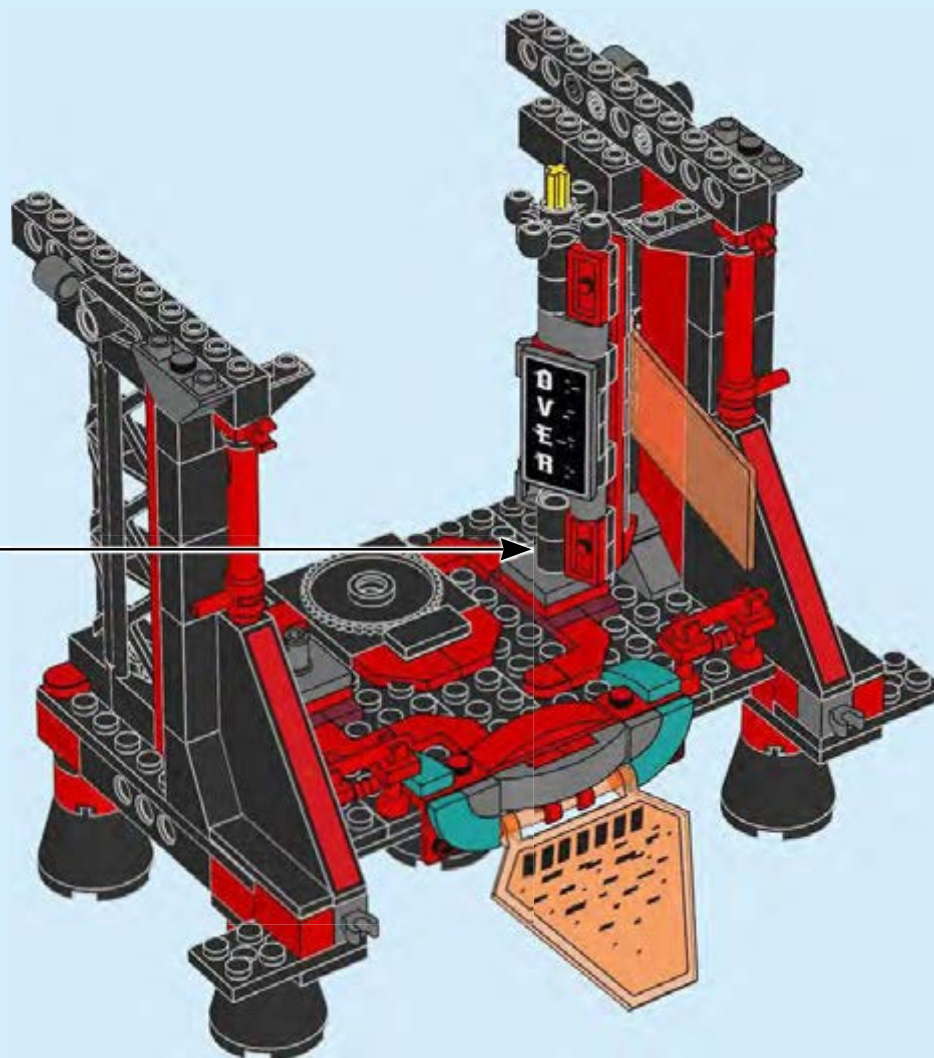

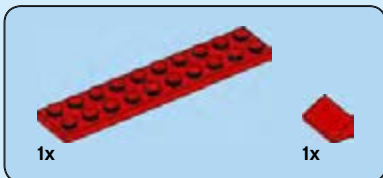

47

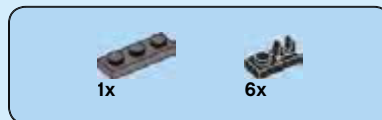
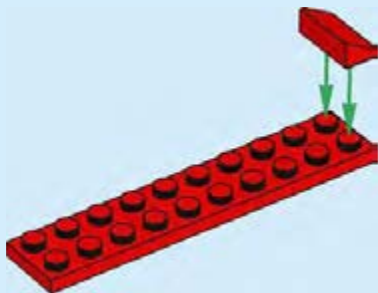

48

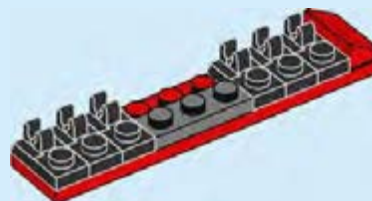

49

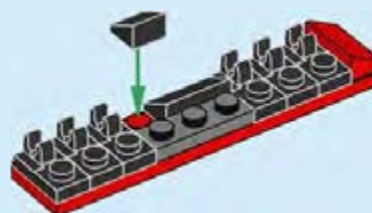



50

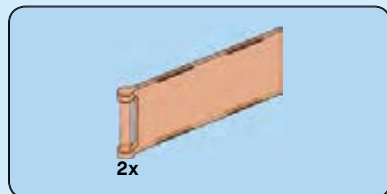
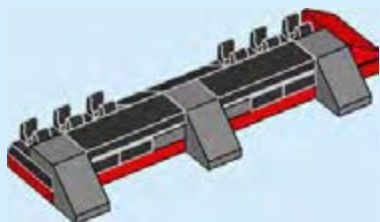

51

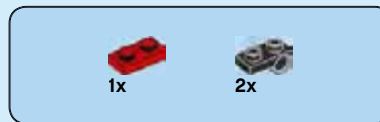
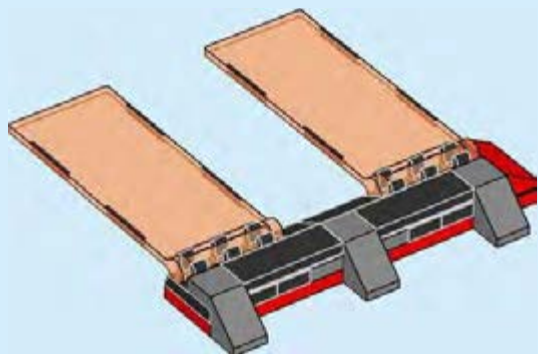

52

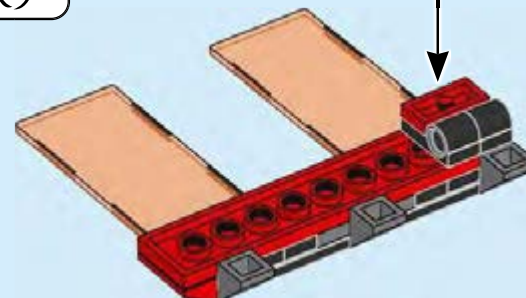
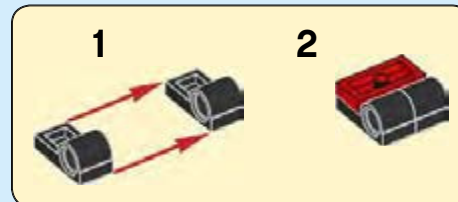



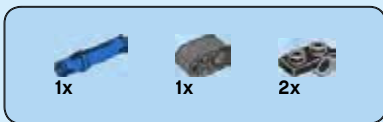

53

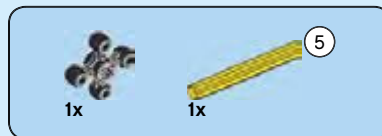
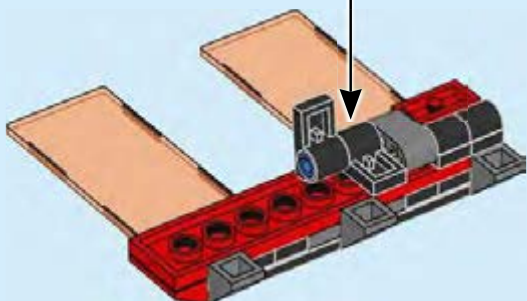

54

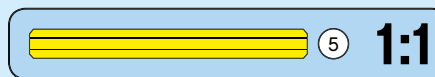
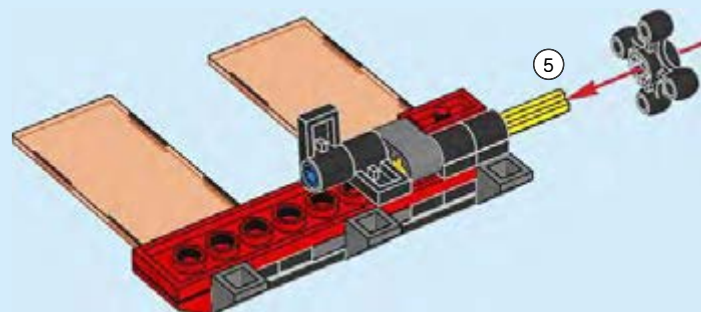

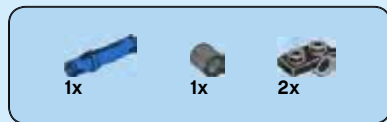

55

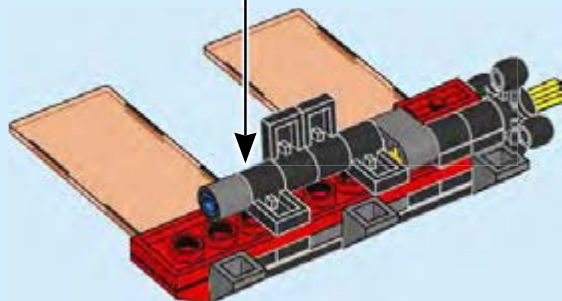

56

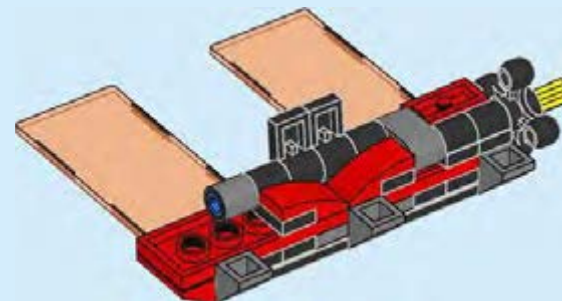

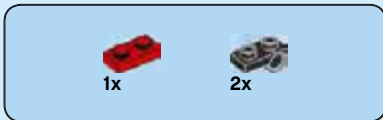

57

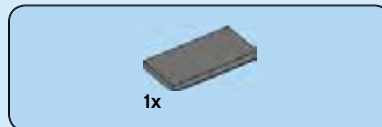
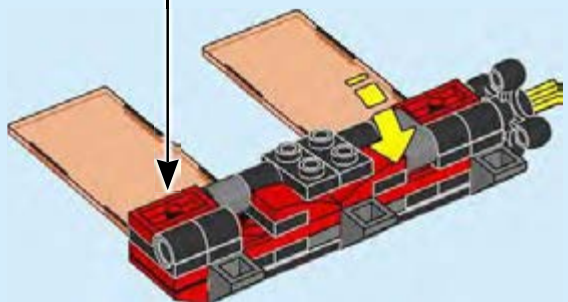
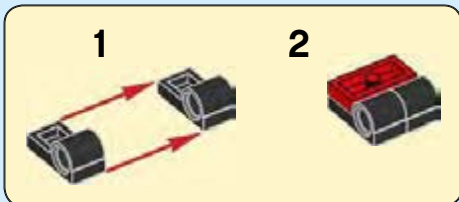

58

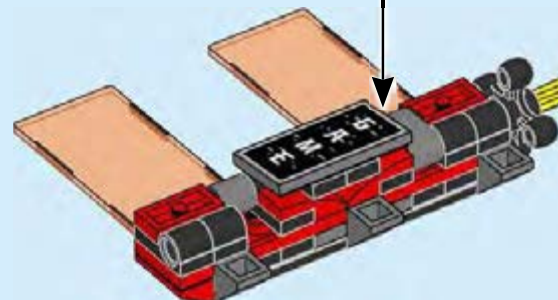
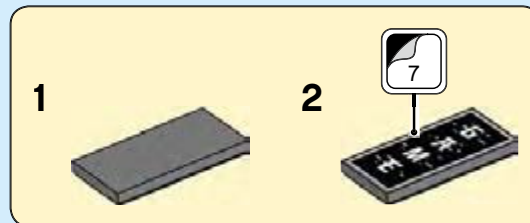

59

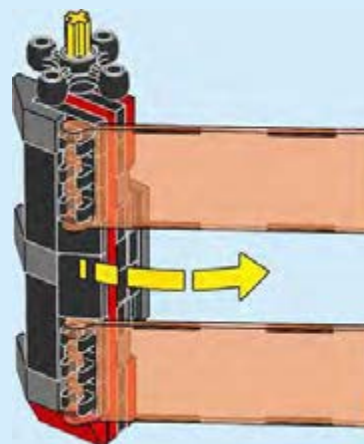
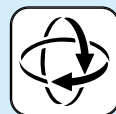

60

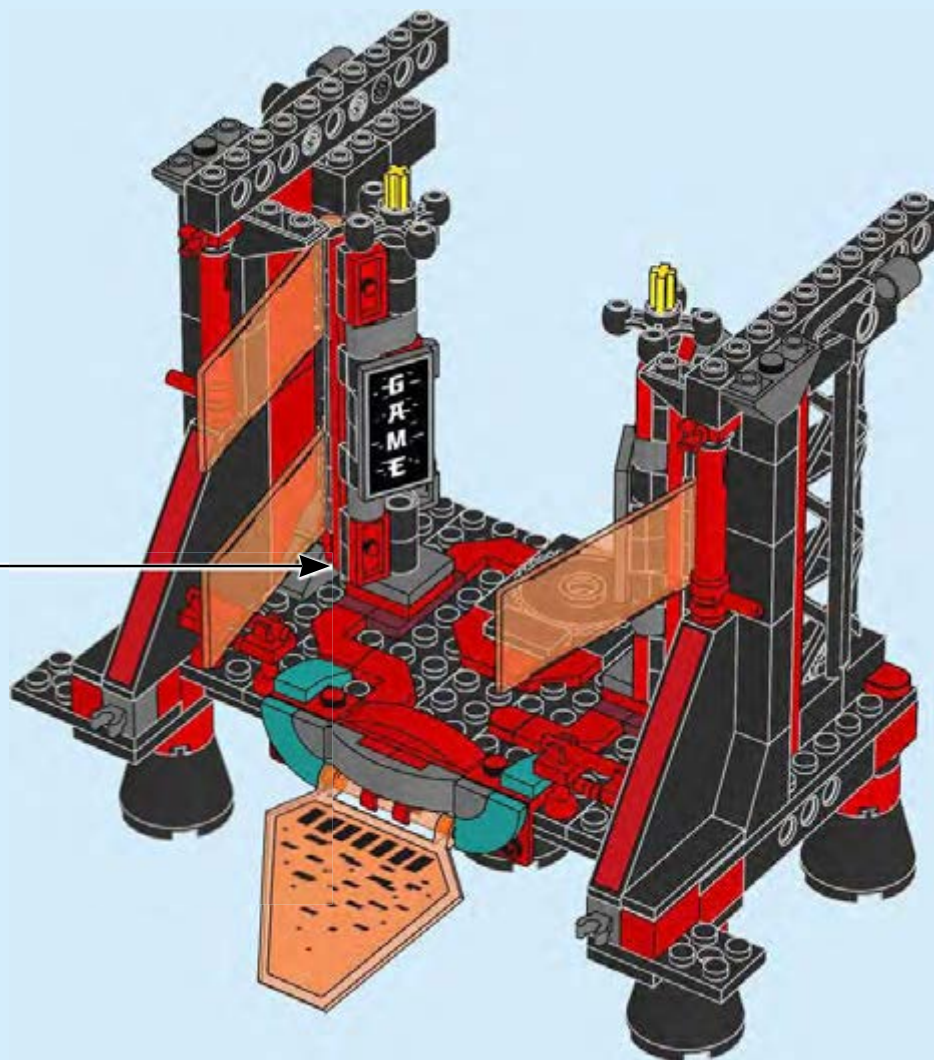



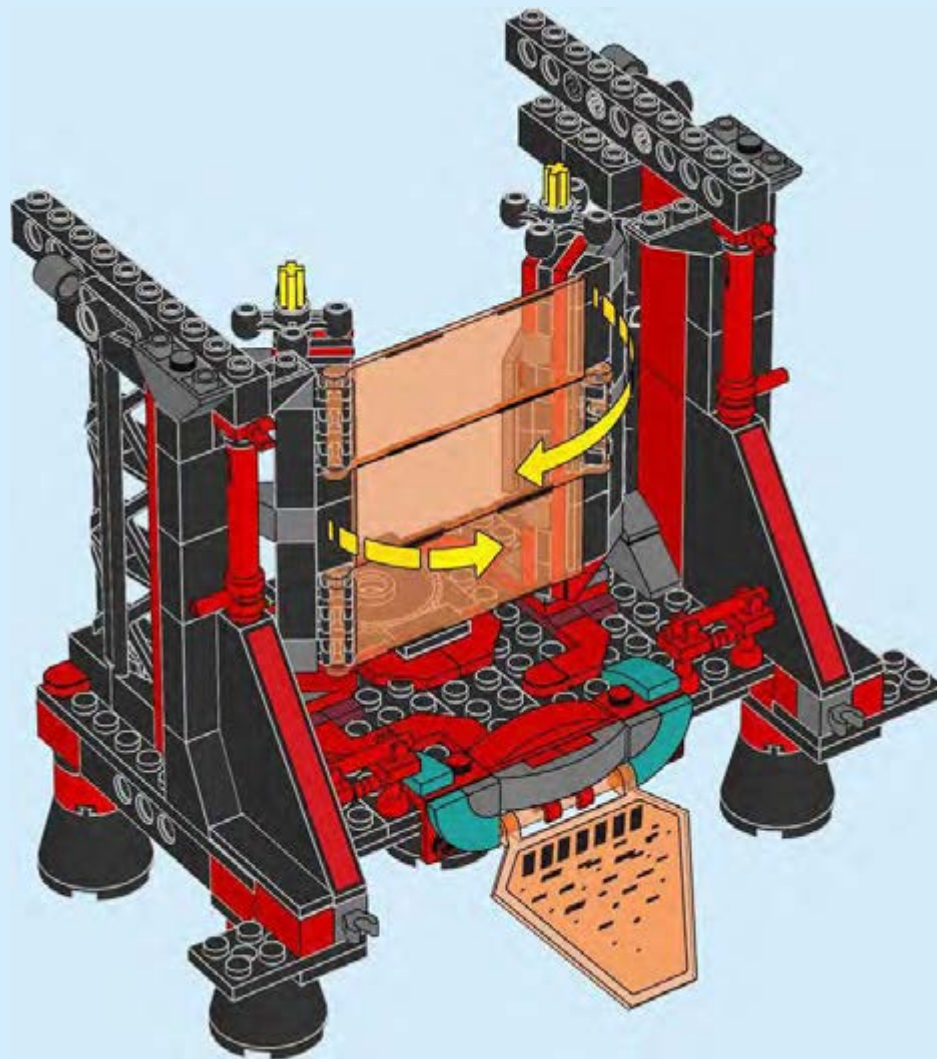

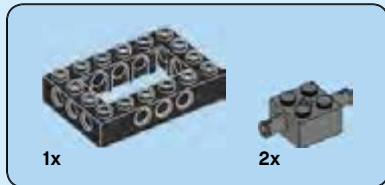

62

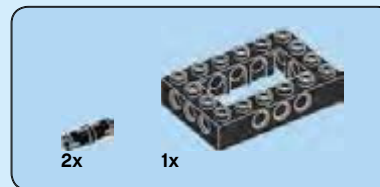
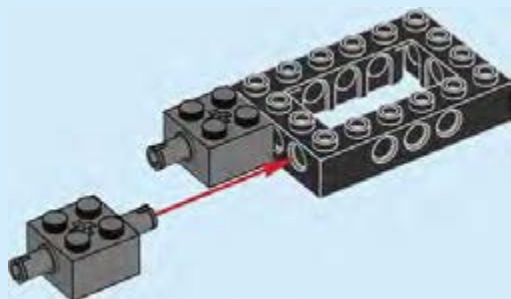

63

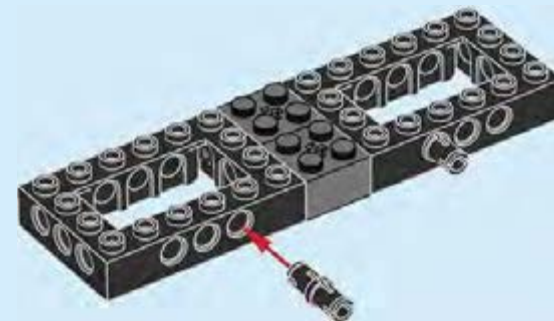

64



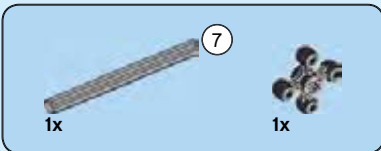

65

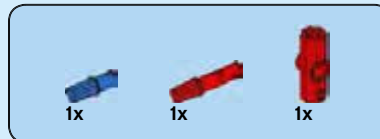

66

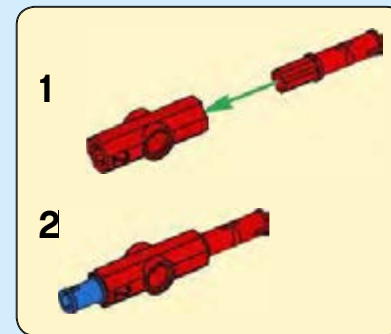

67

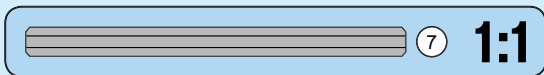
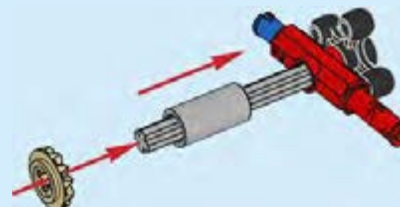

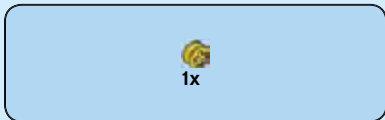

68

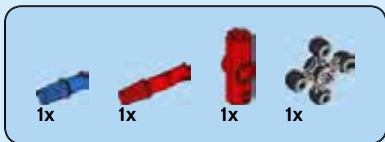

69

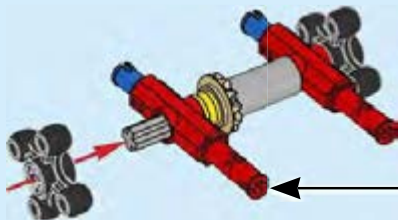
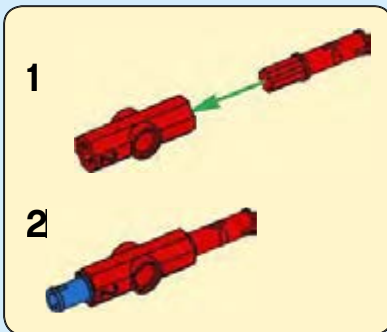

70

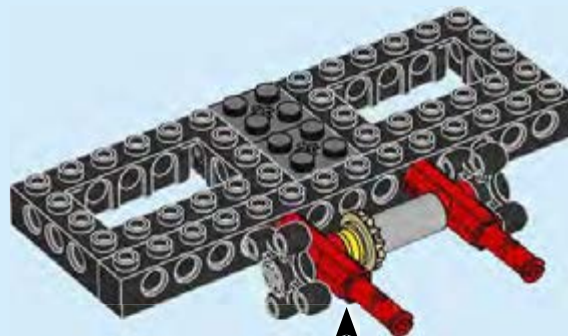



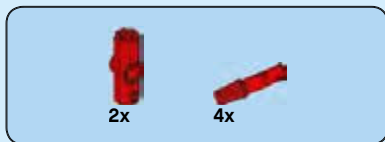

71

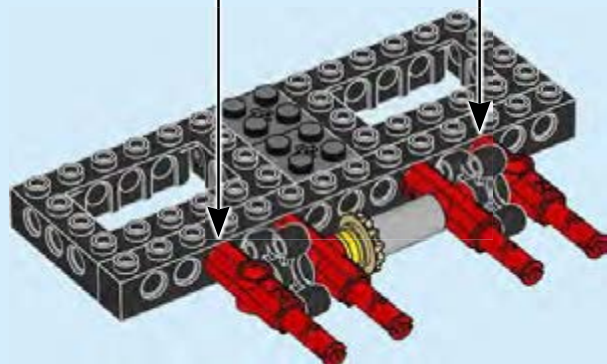
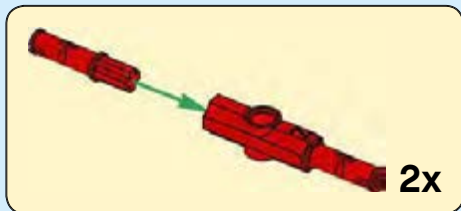

72

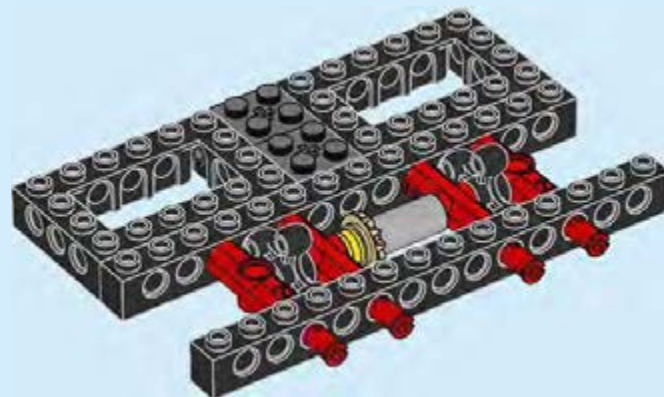

73

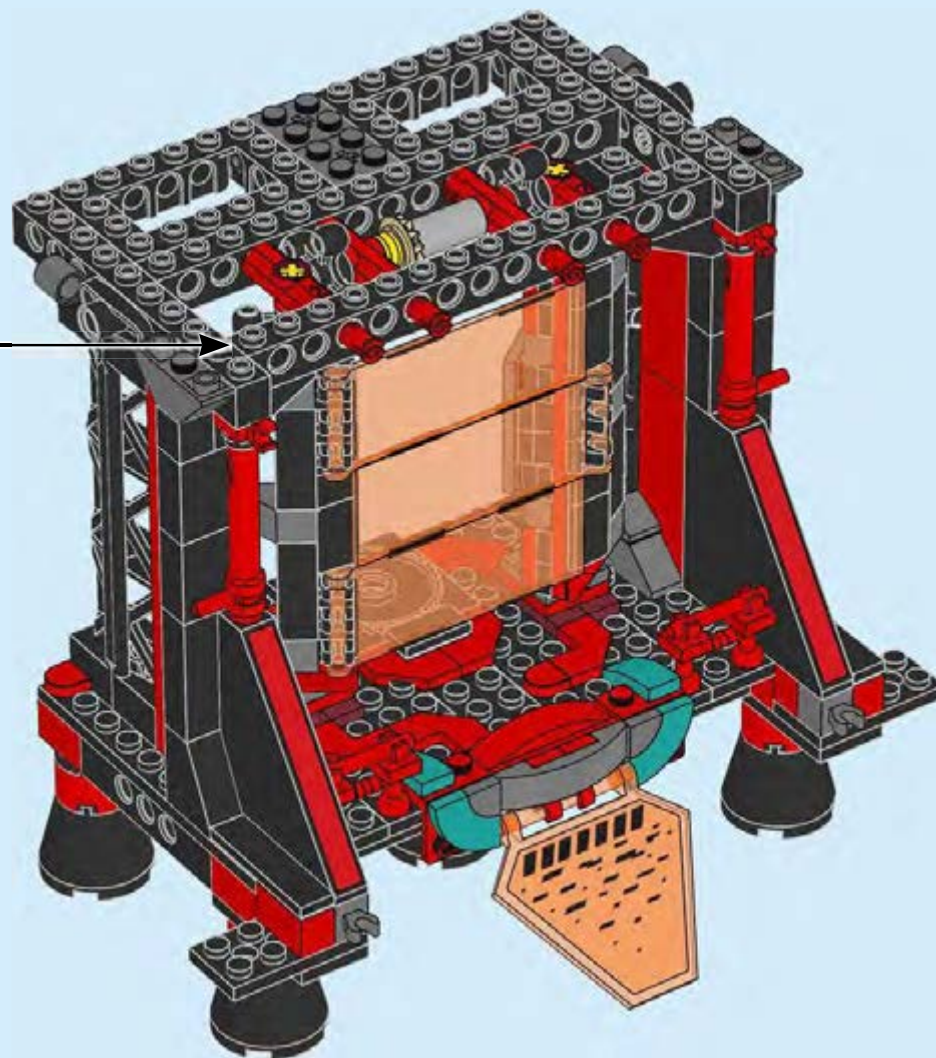





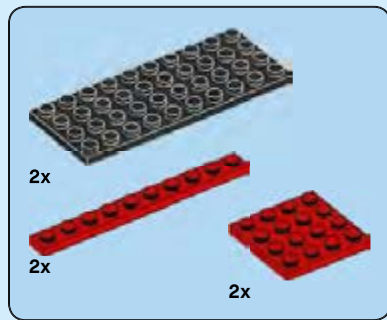

75

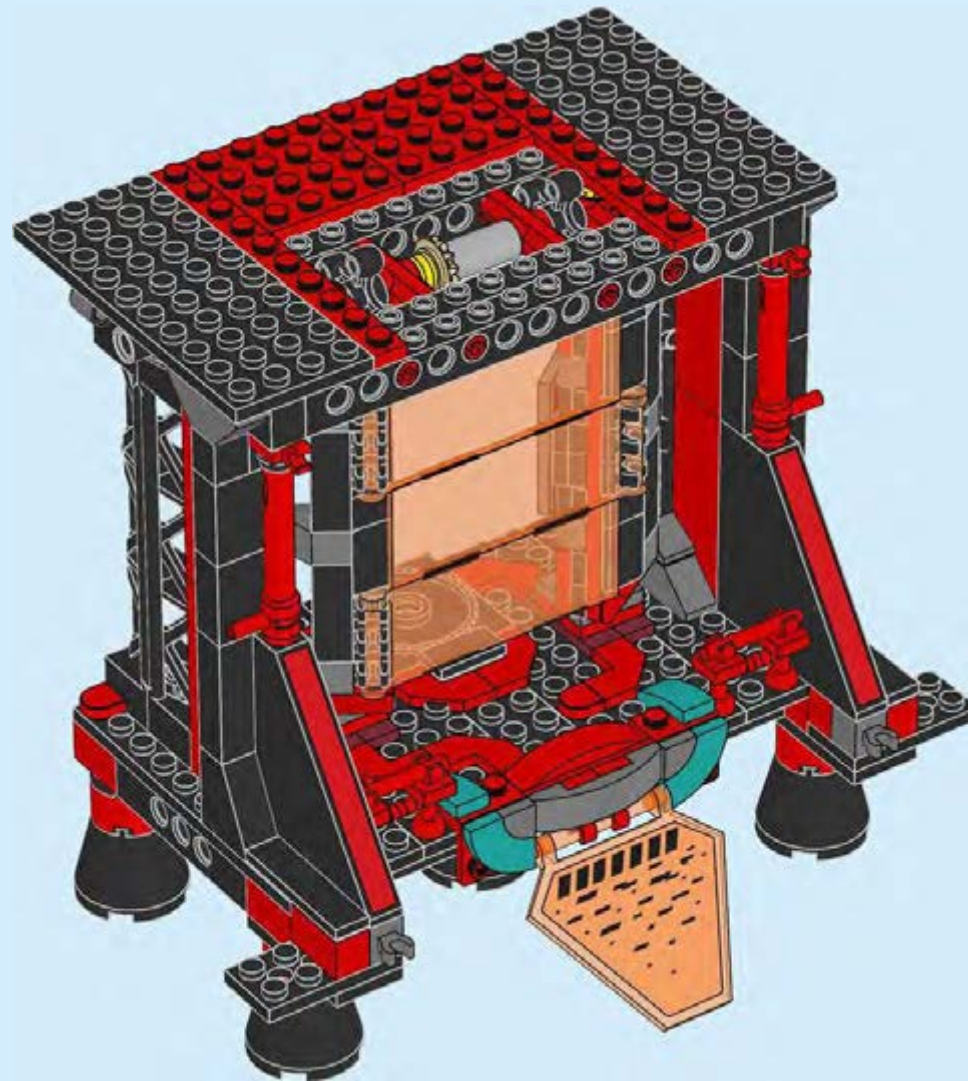





76

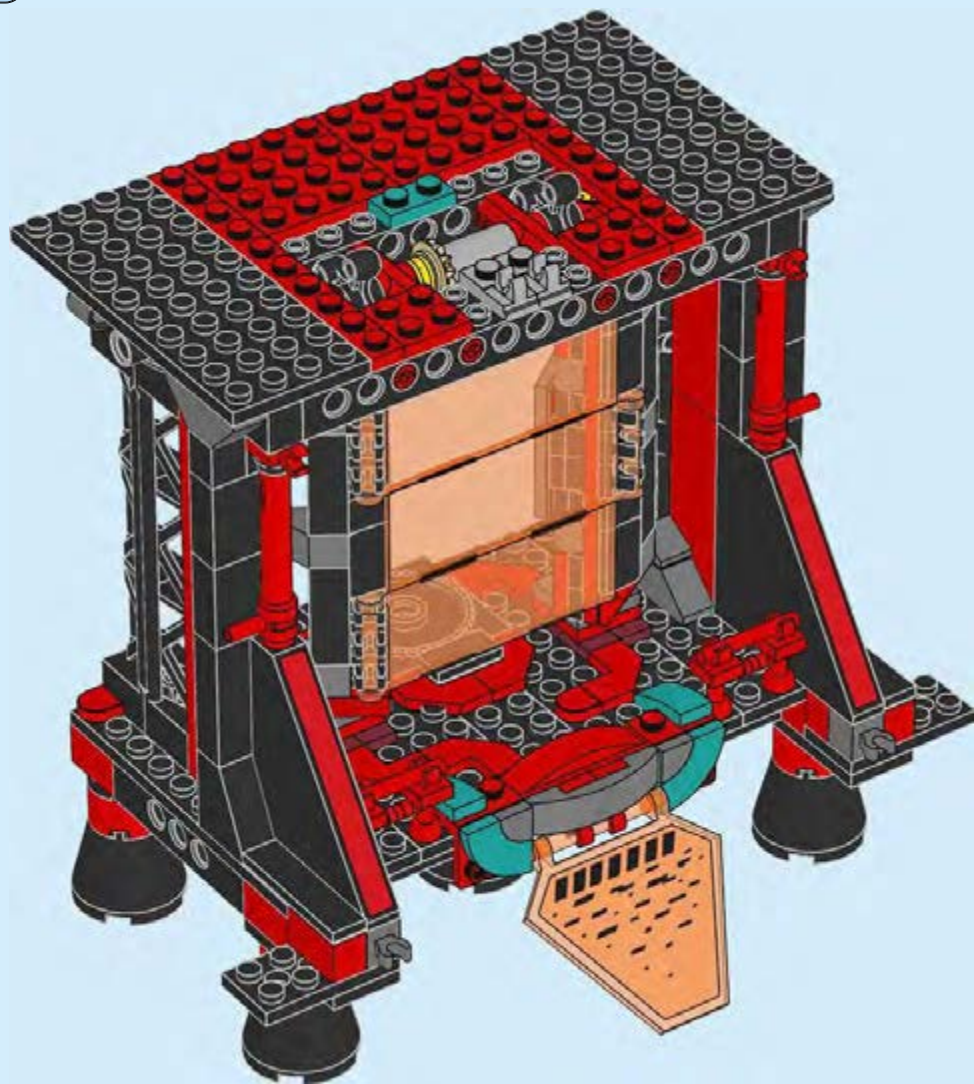

54

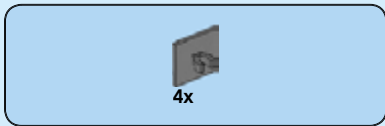

77

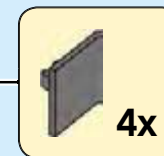
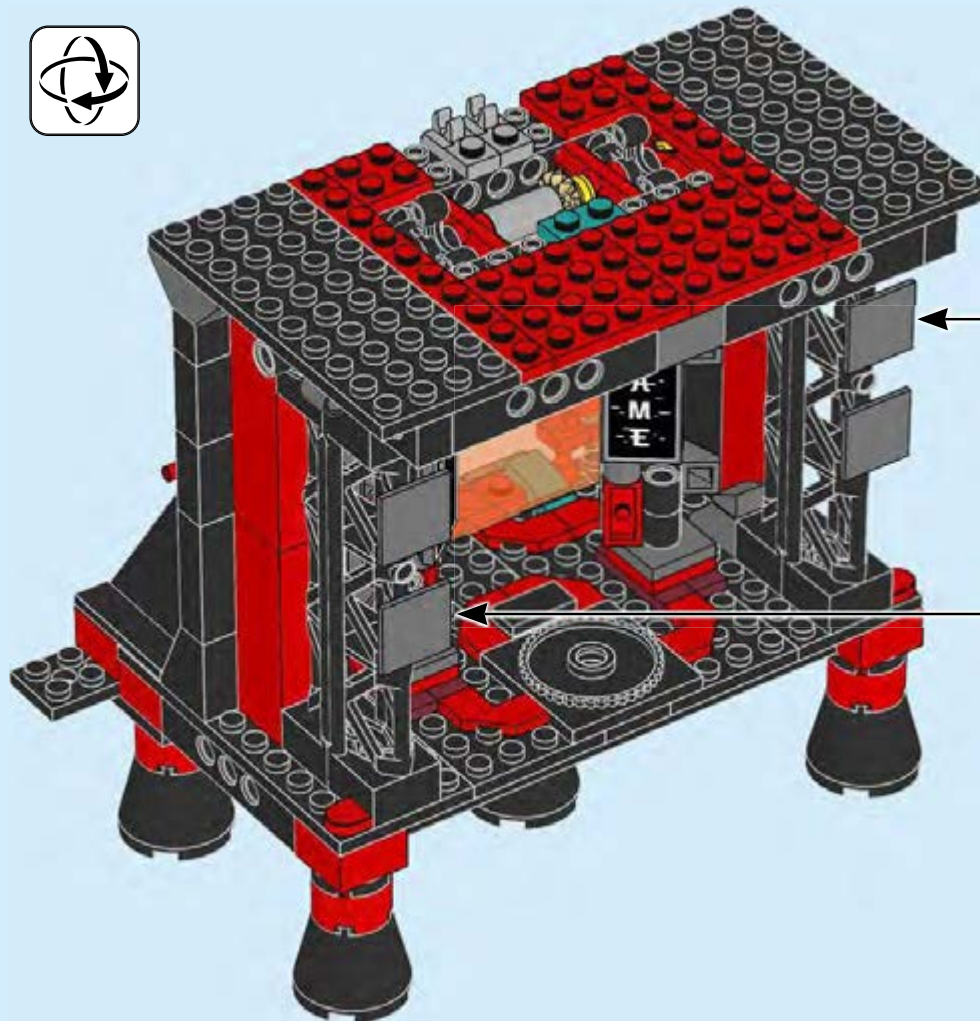

78

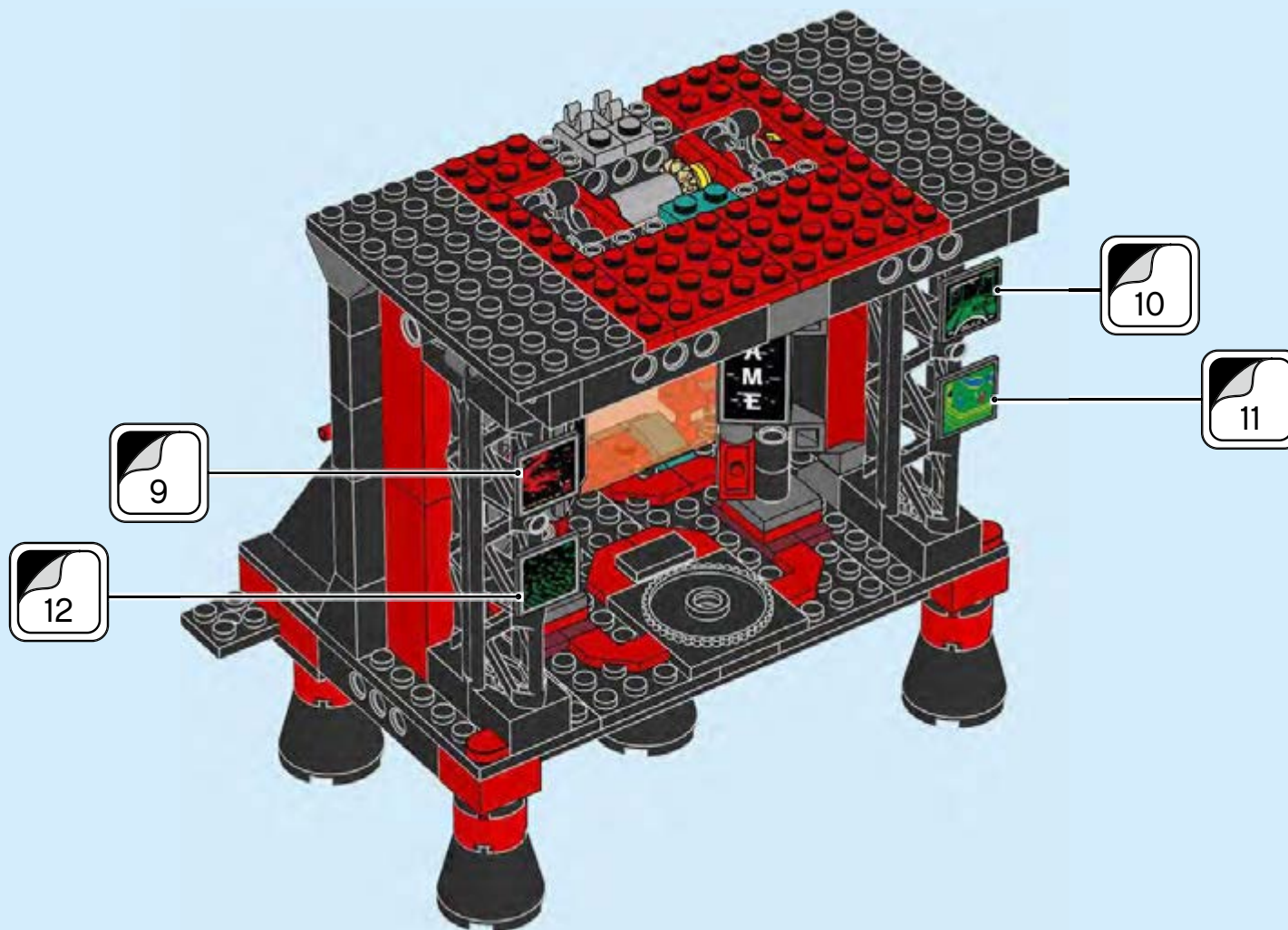

56

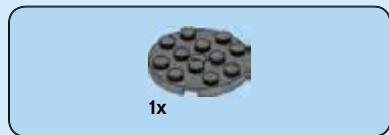

79

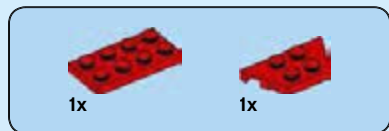

80



81



82





4x

1x

83



2x

1x

84



1x

1x

85



2x

2x

2x

86

1

2

2x



87

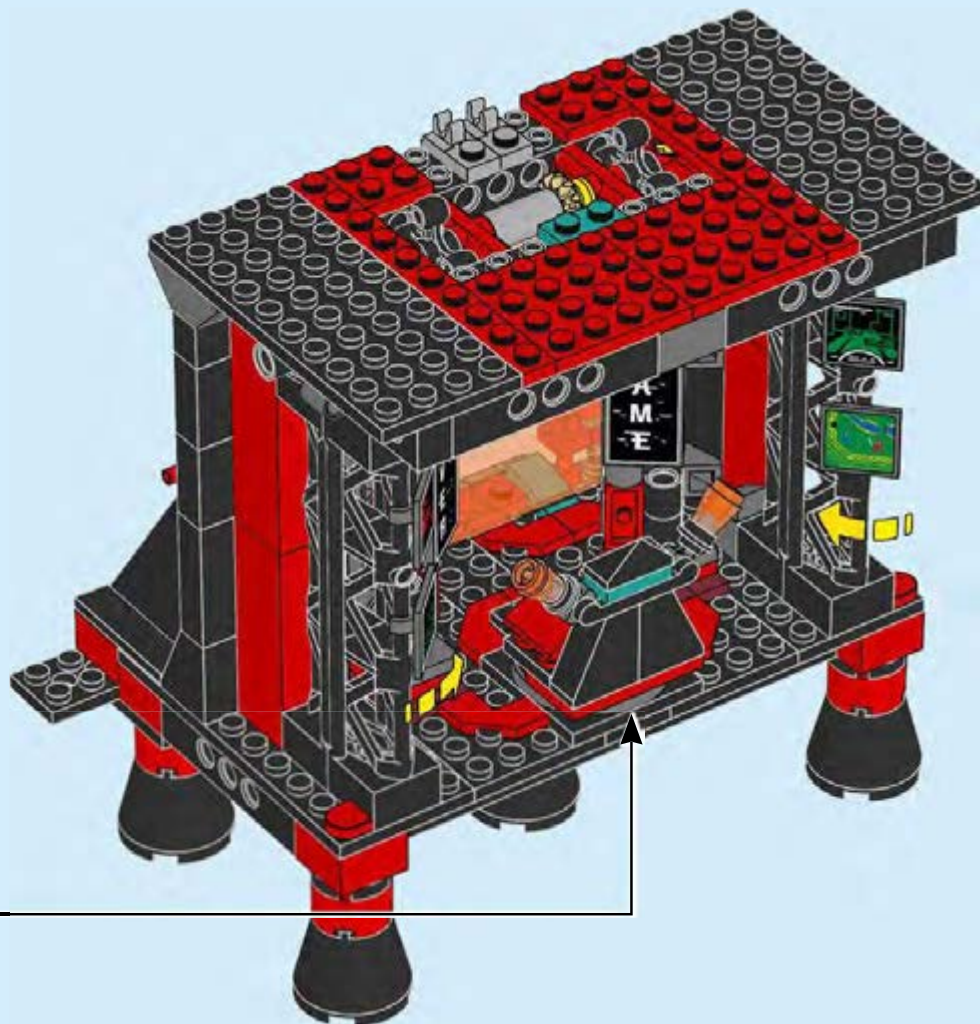

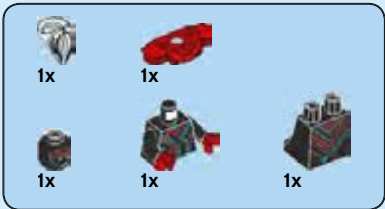

1



2

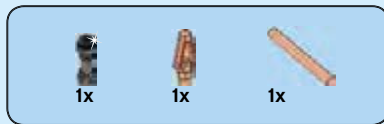
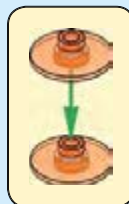

3



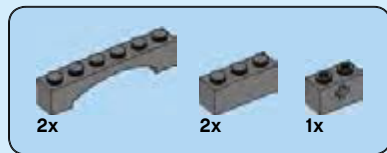

88

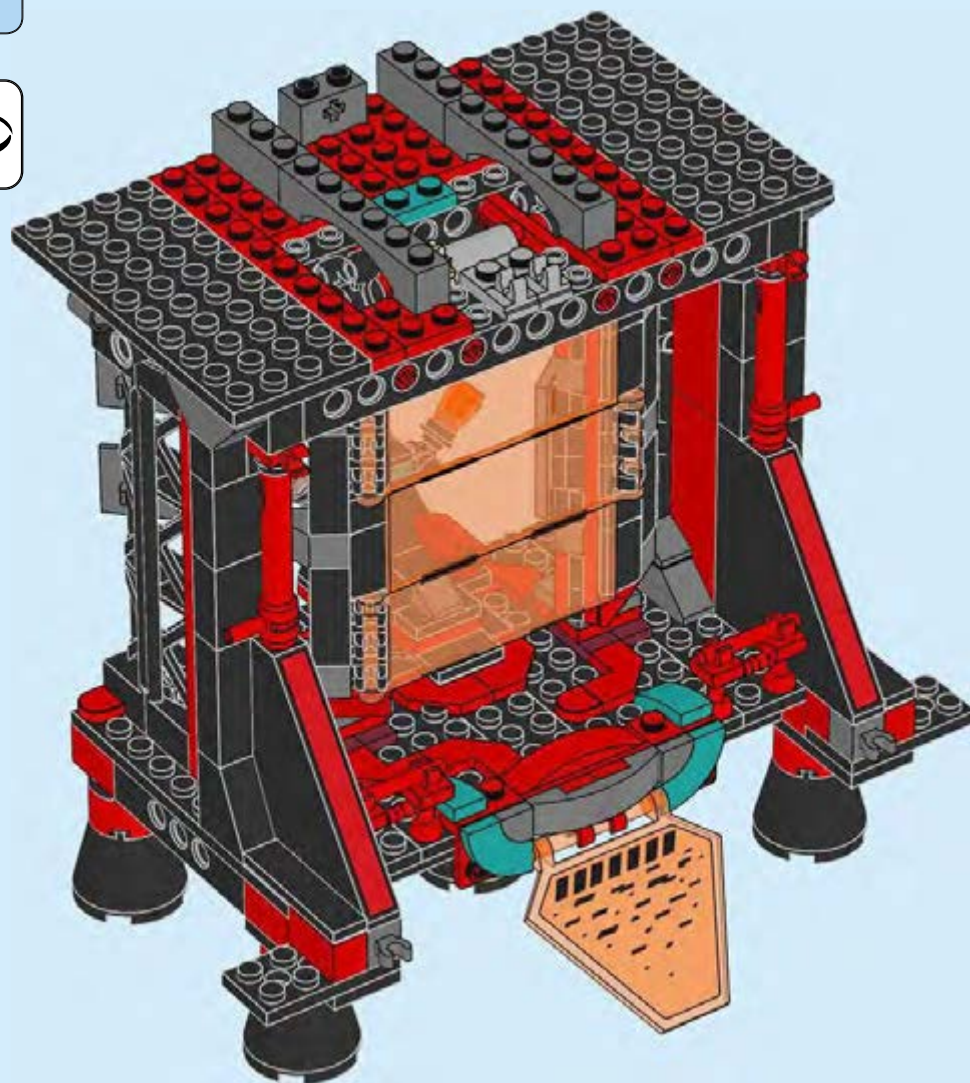



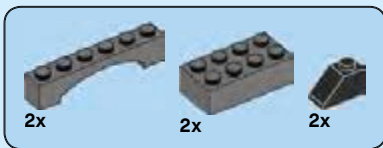

89

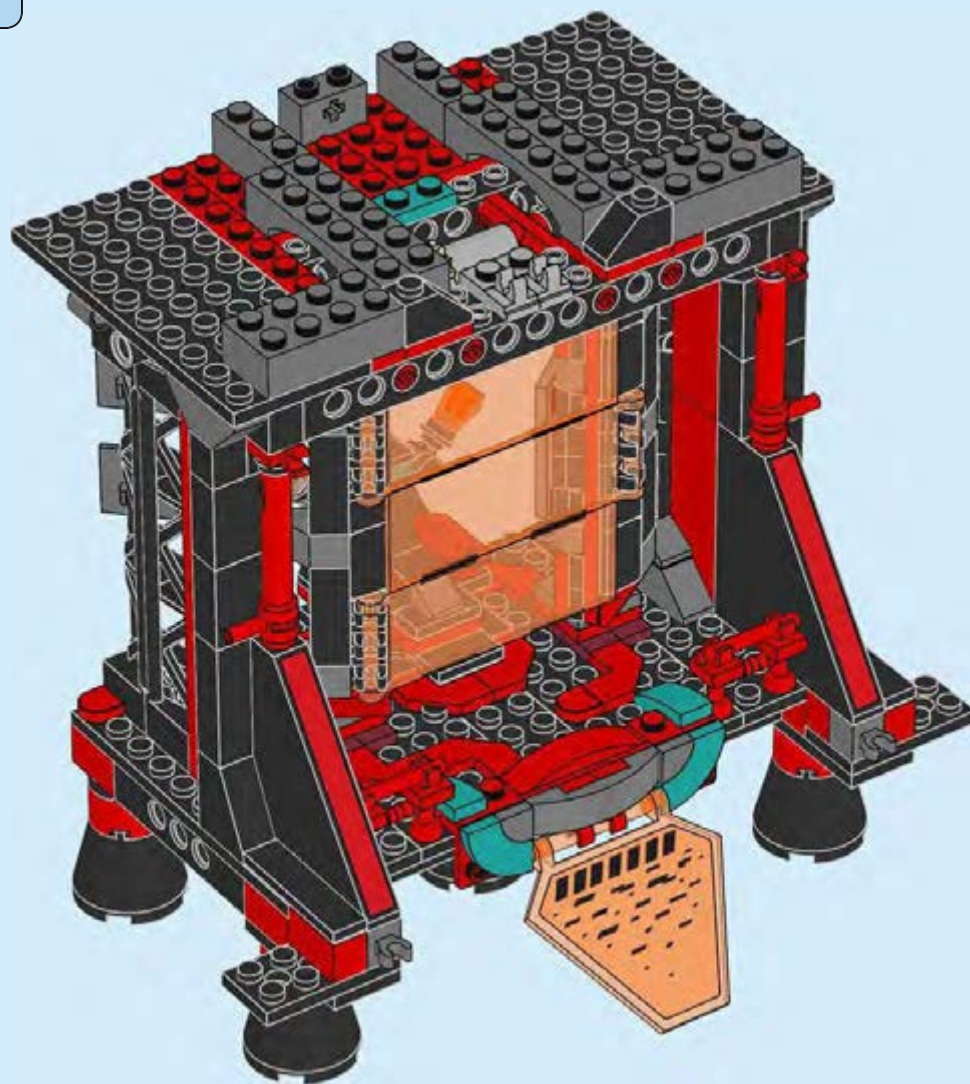

62



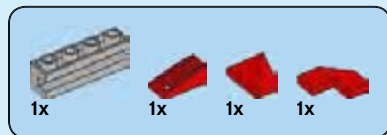

90

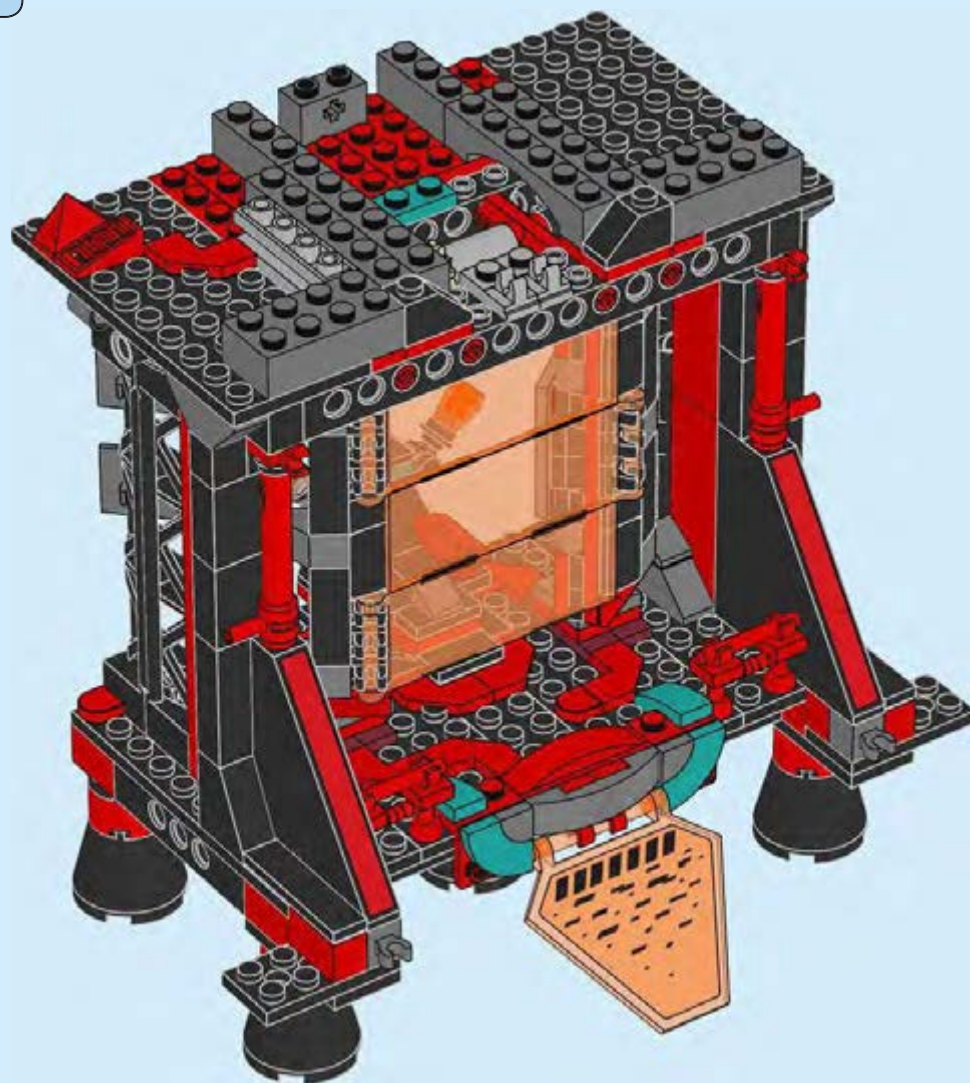



91

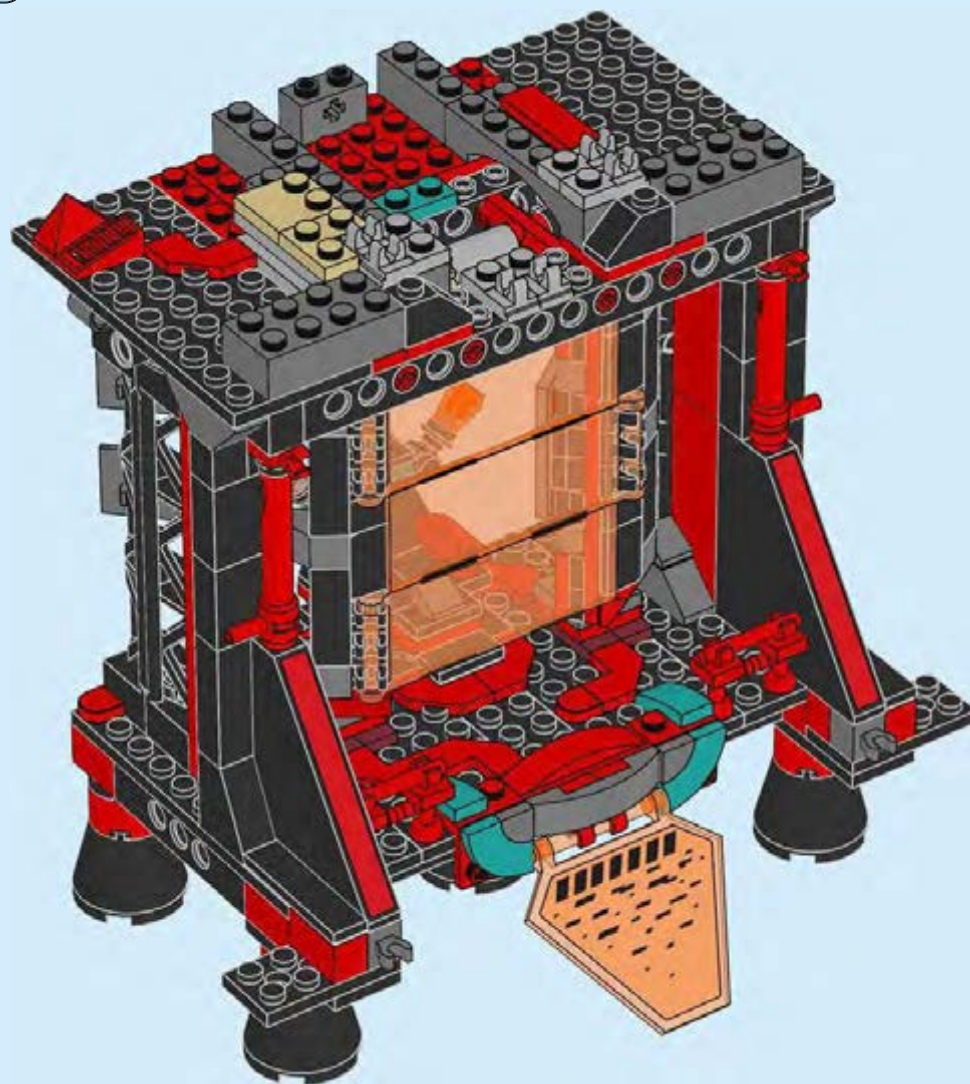

64



92

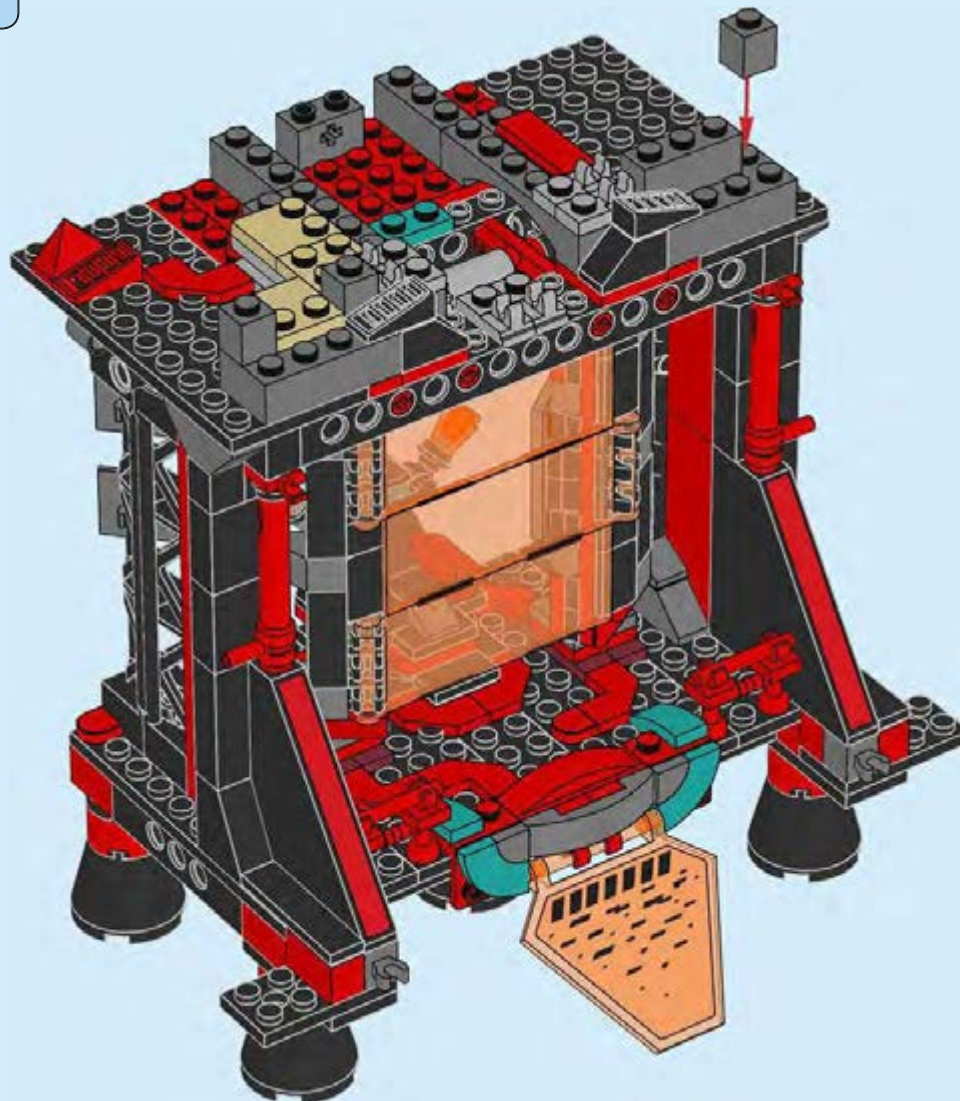





93

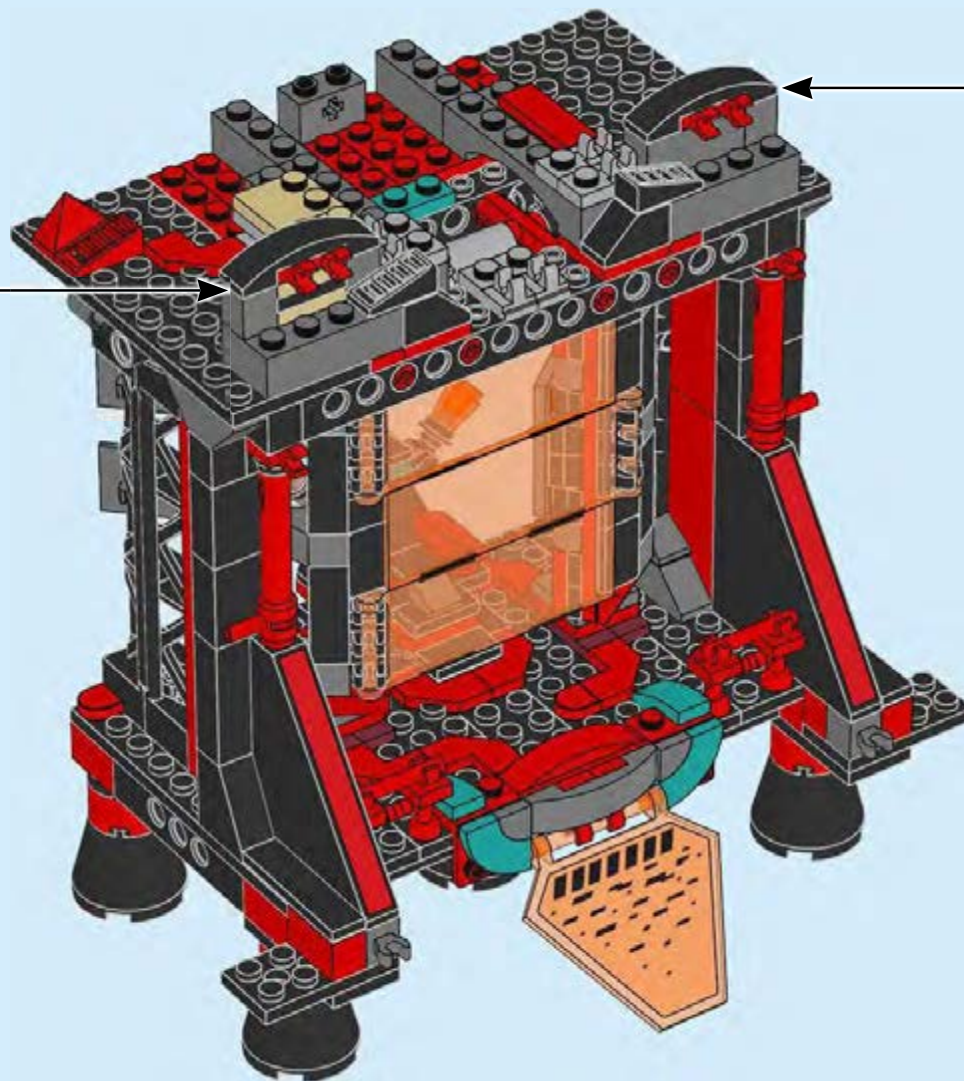
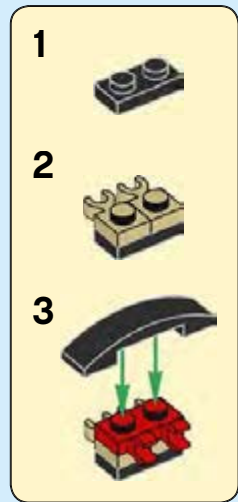



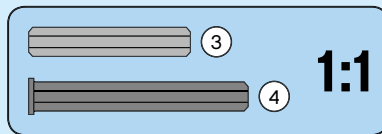
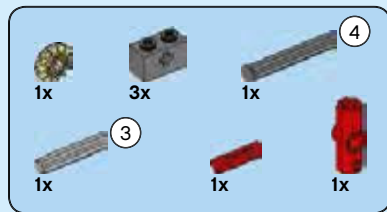

94

1



2

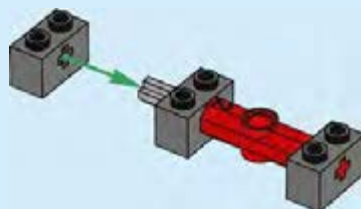

3

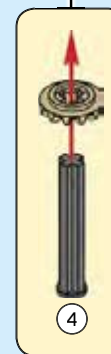
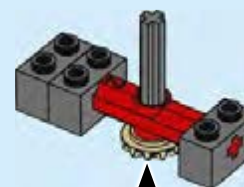

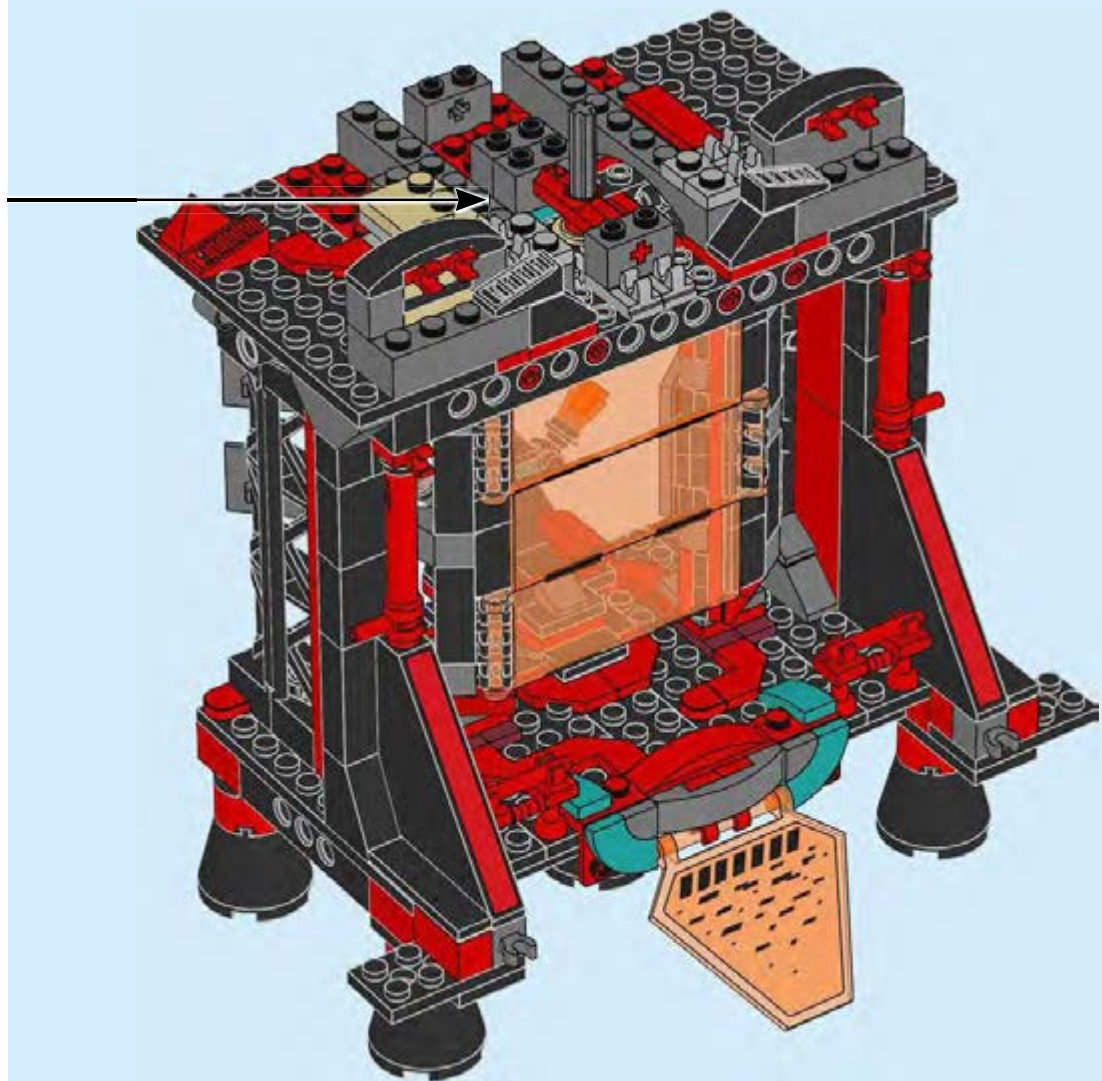



95

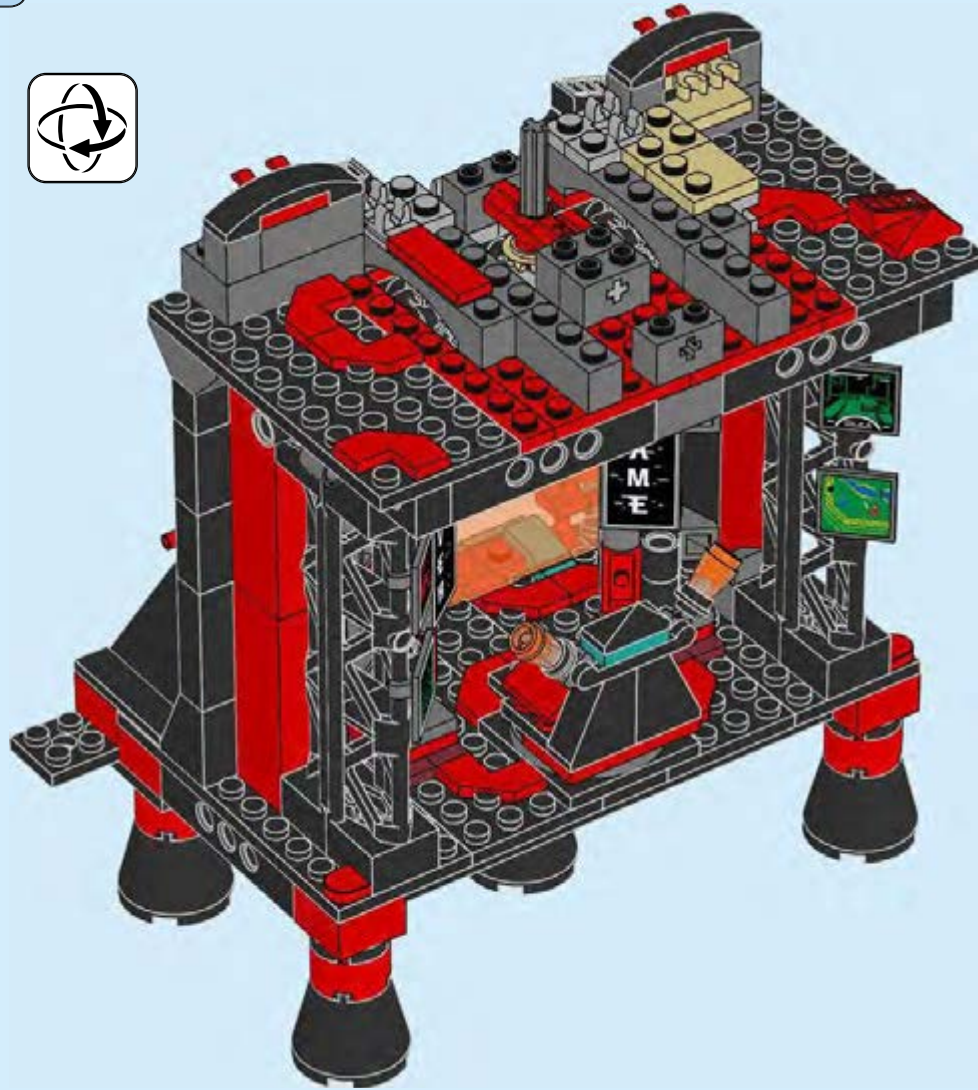



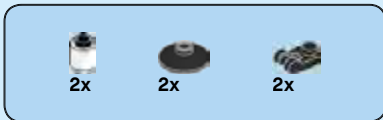

96

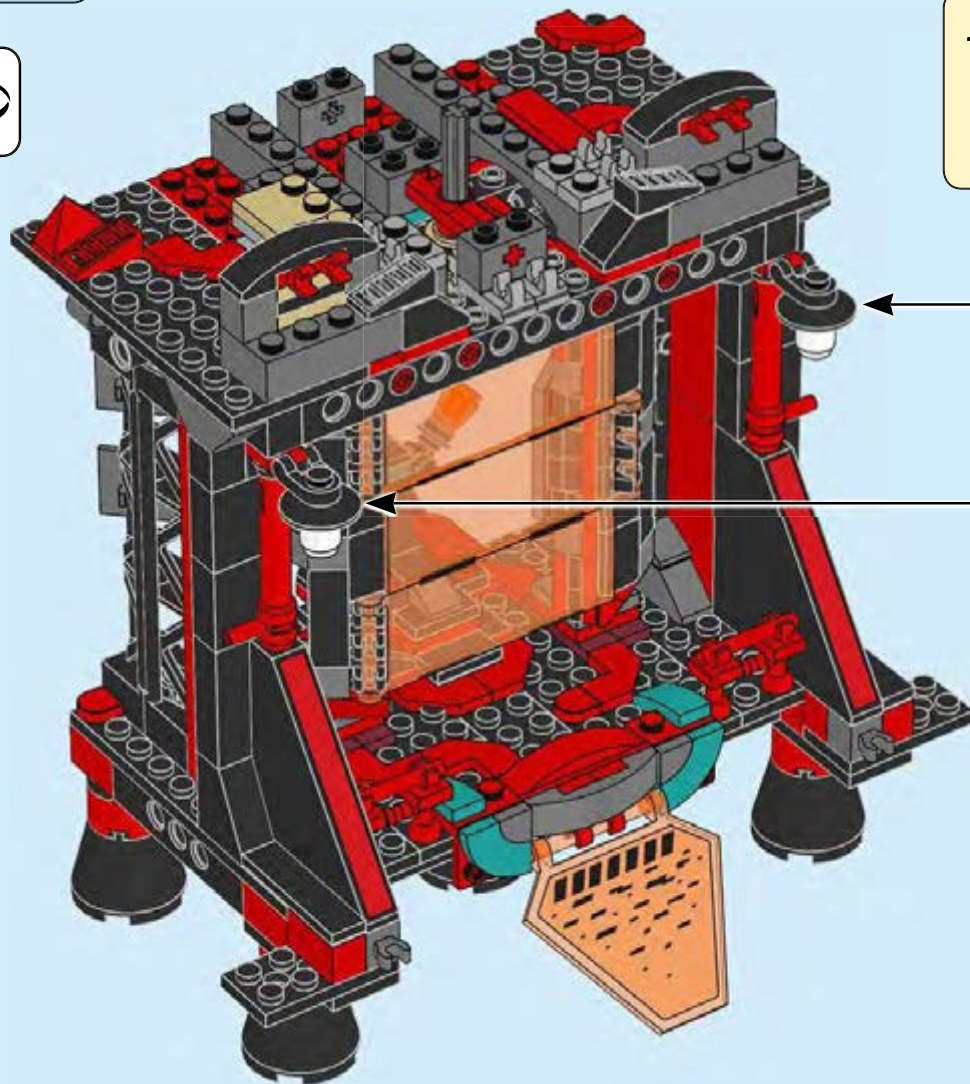



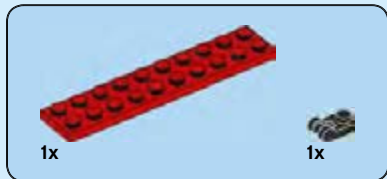

97

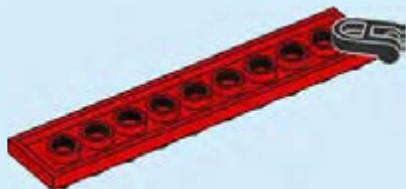

98

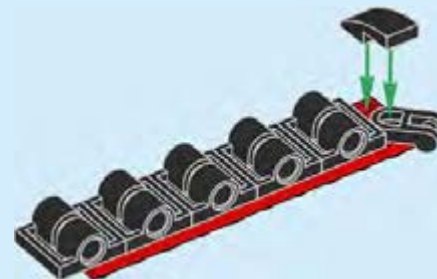

99

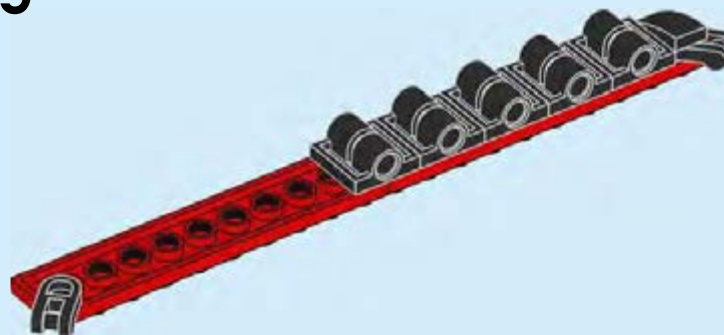



100

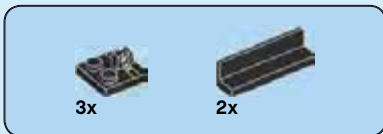
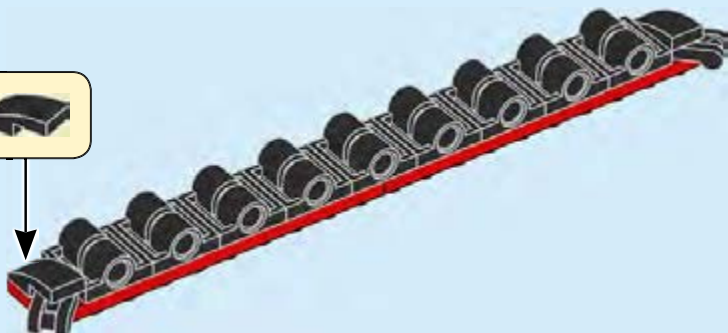

101

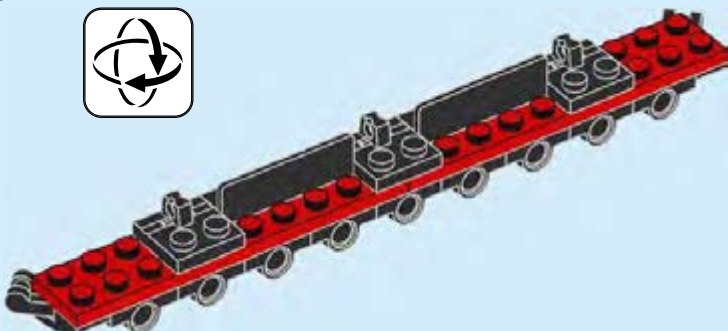

102

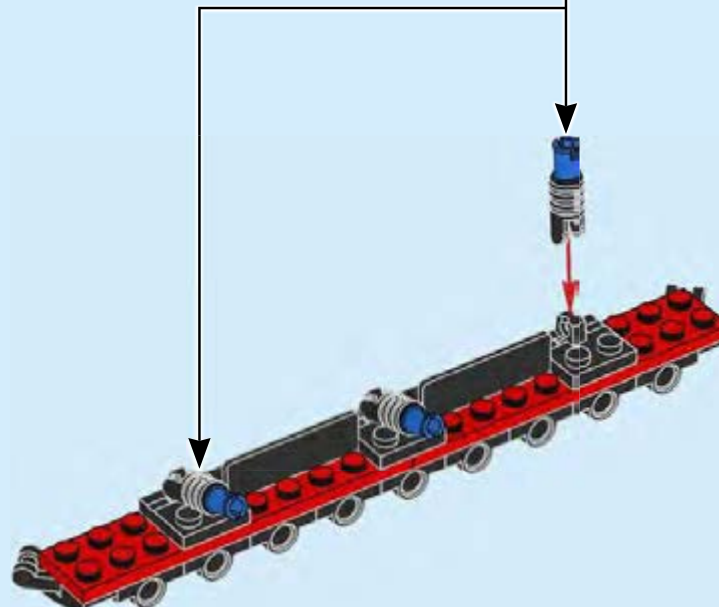
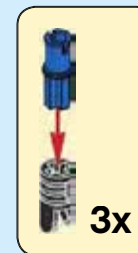



103

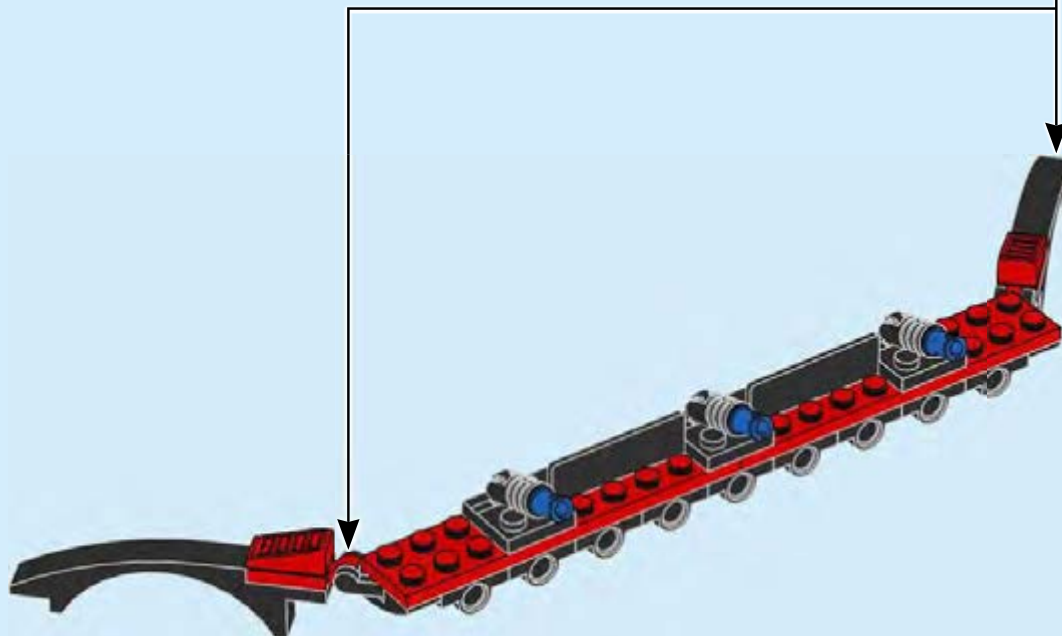

104

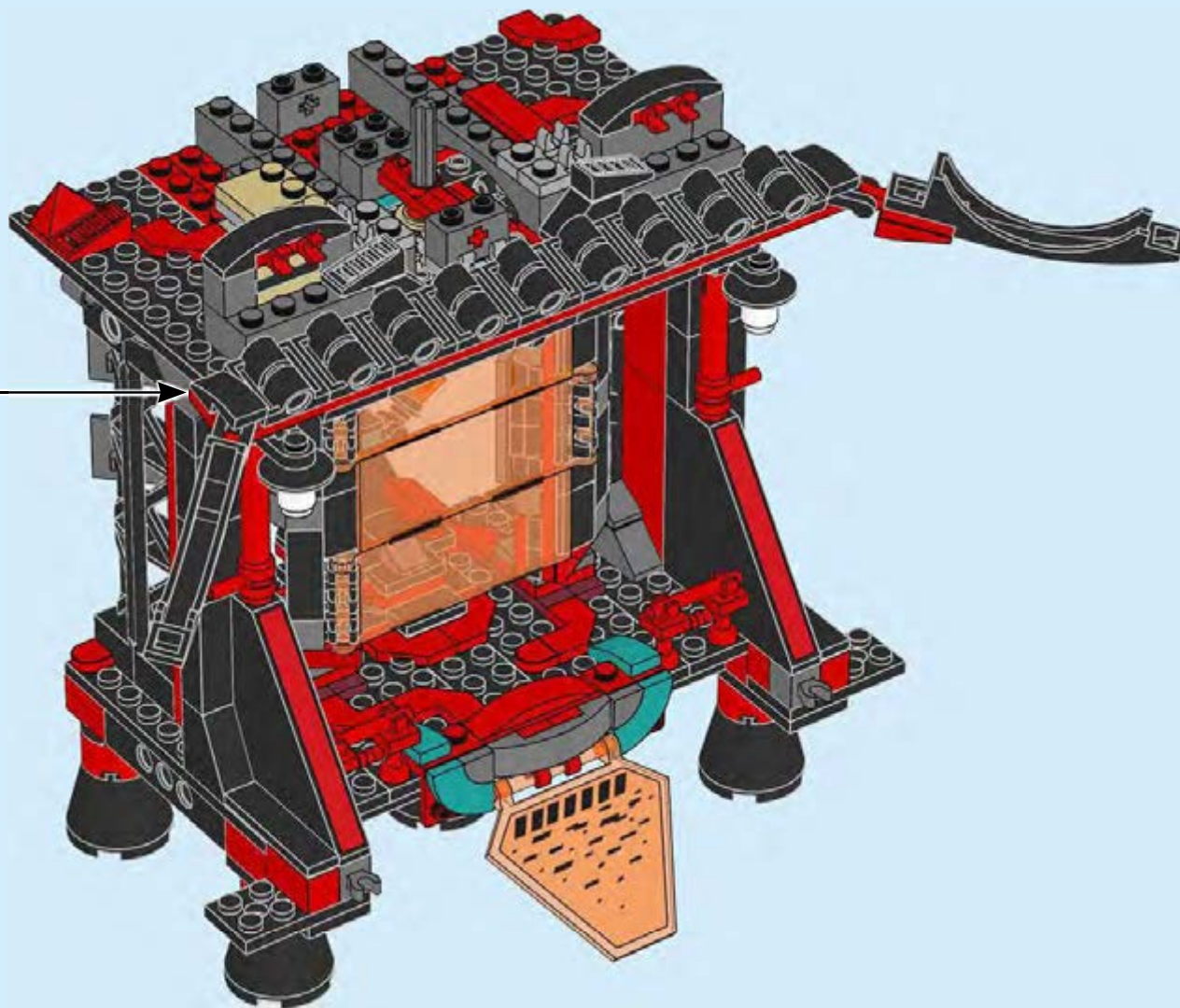

74





# 105

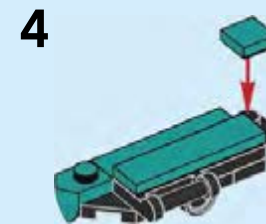
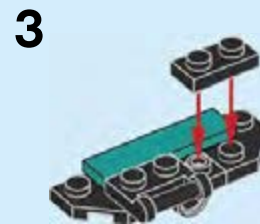
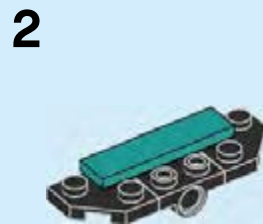
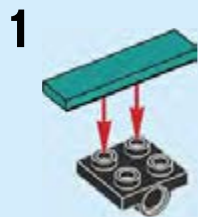

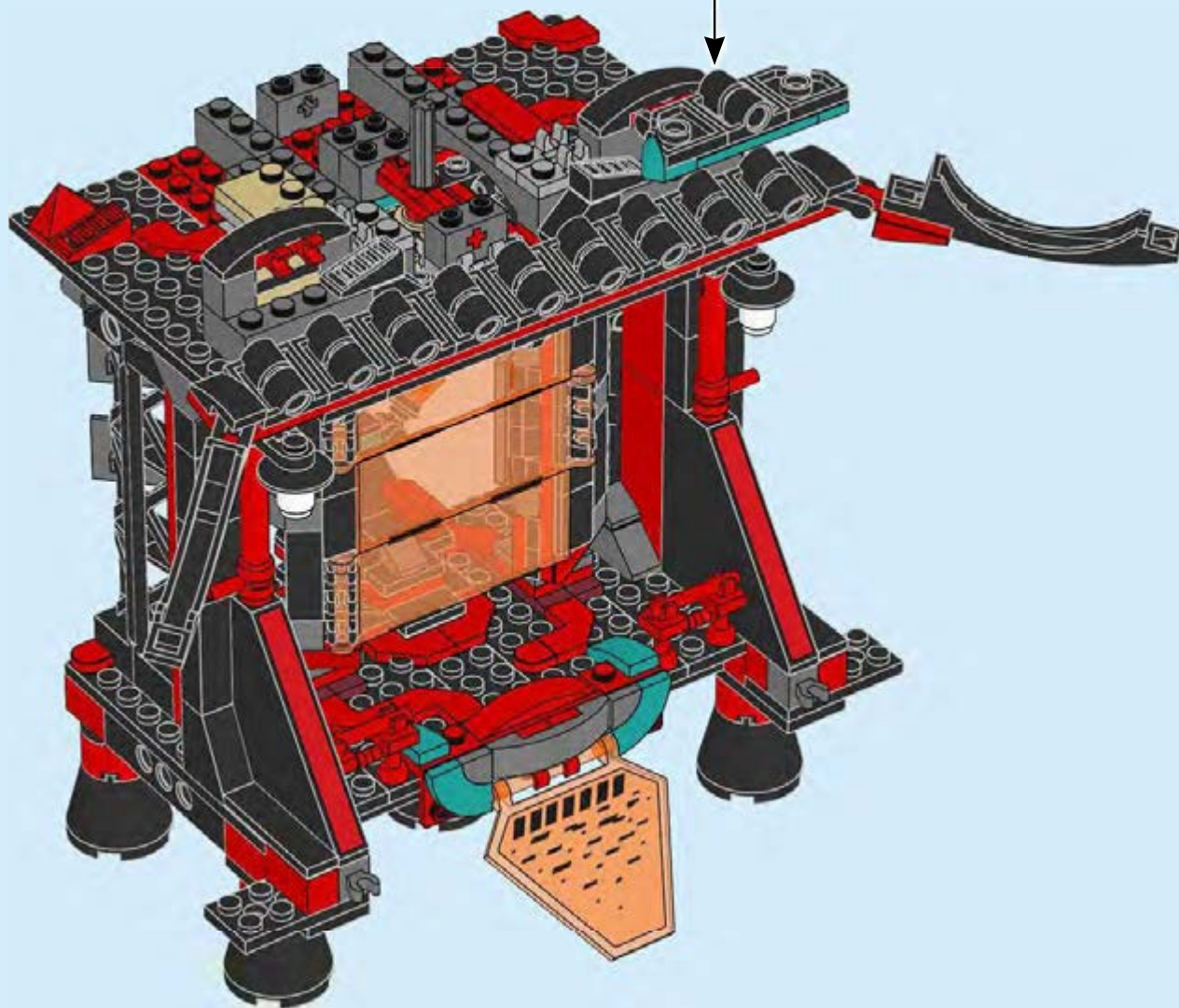



# 106

1

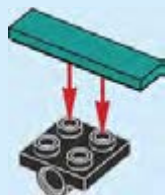

2



3



4

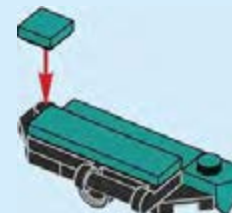

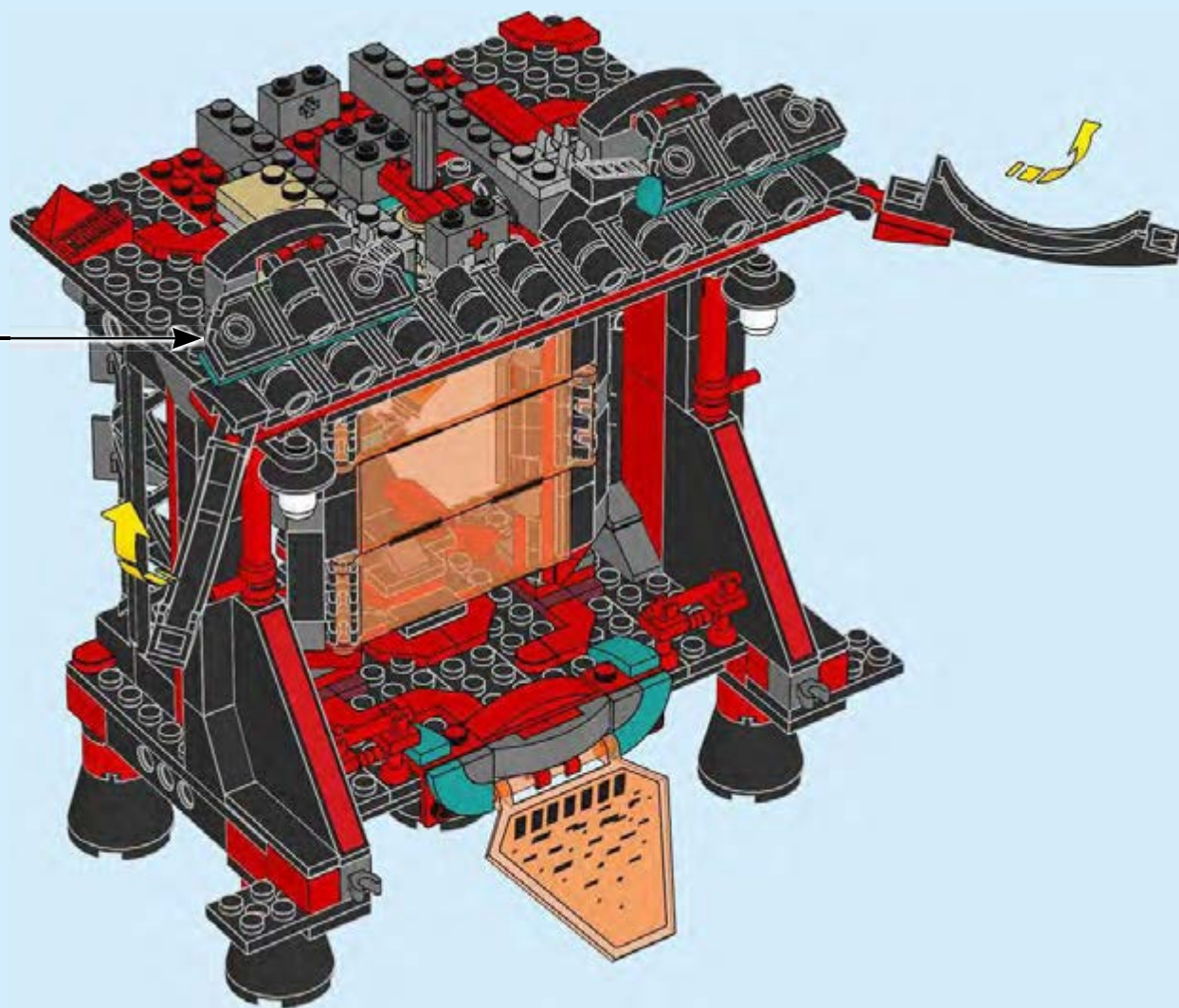



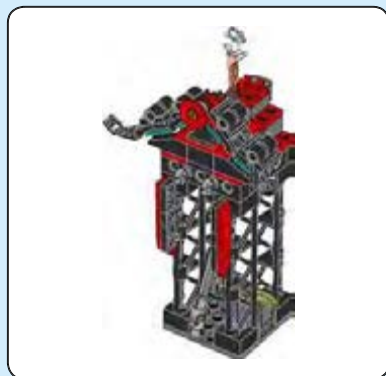

107

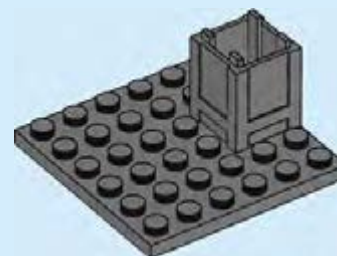

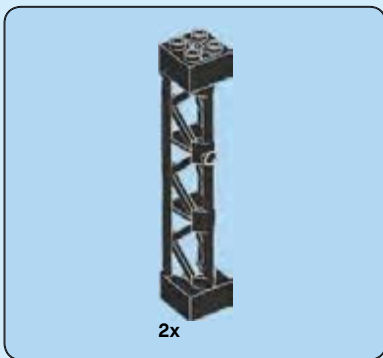

108

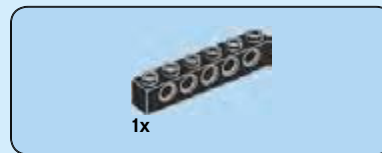
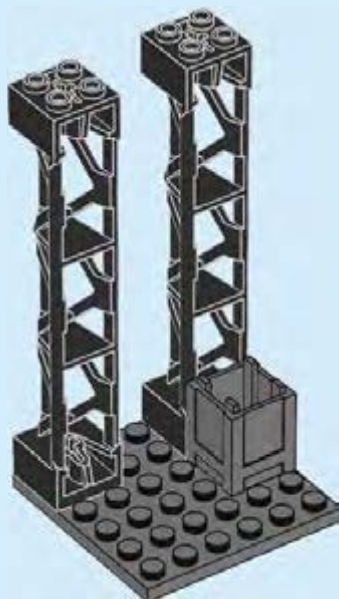

109

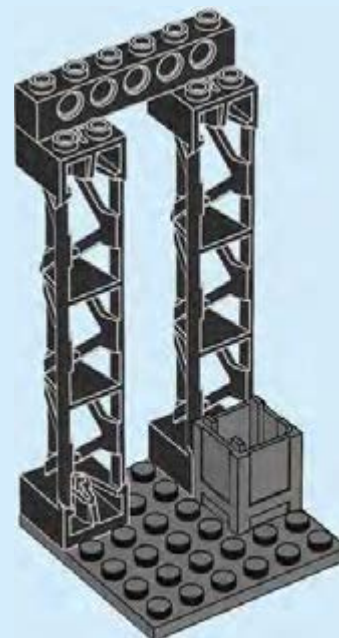

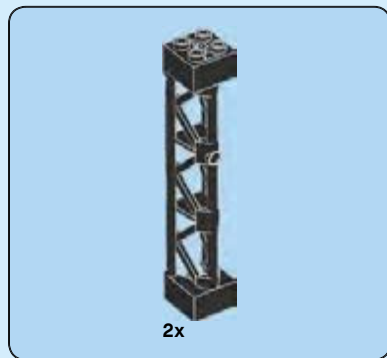

110

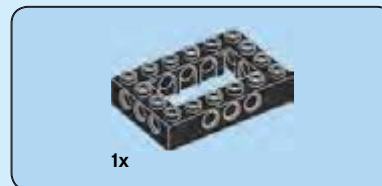
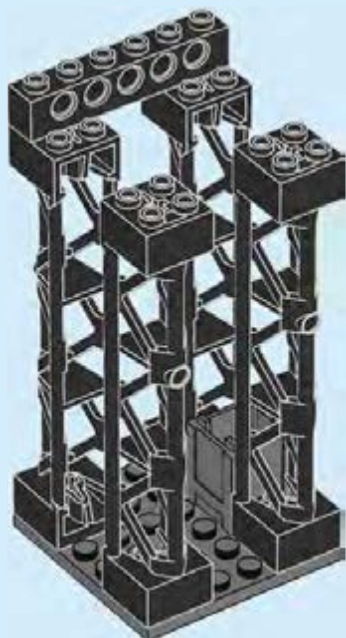

111

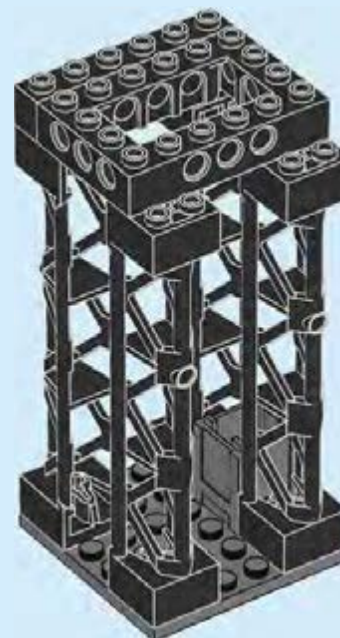

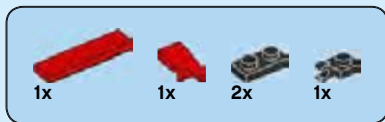

112

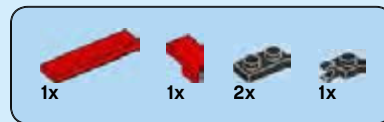
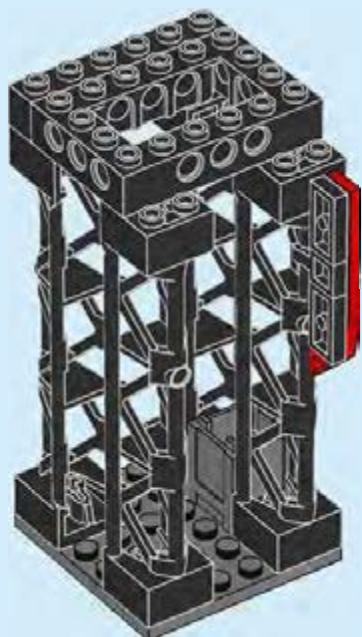
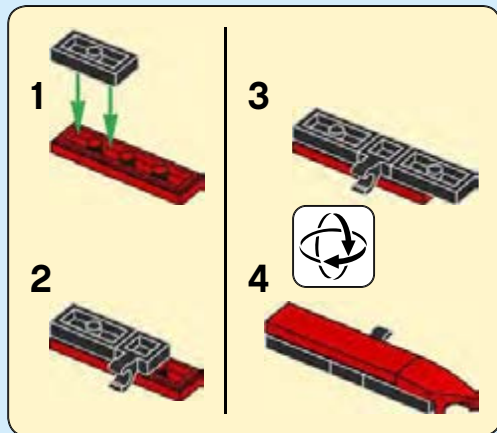

113

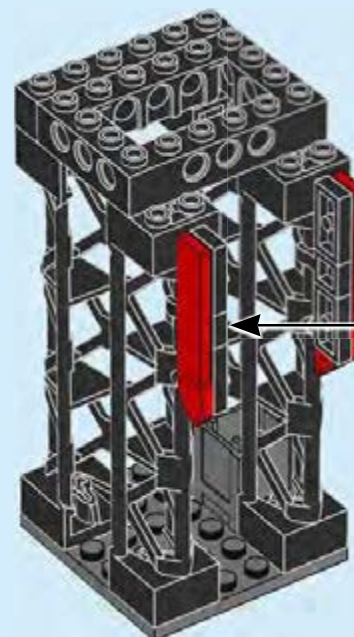
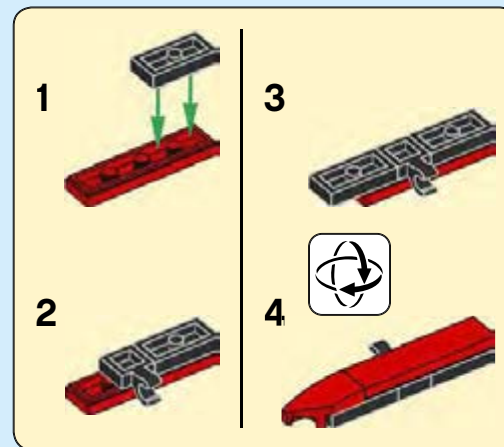





114

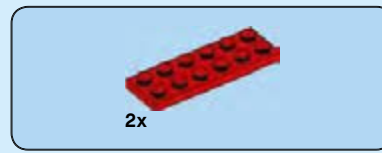
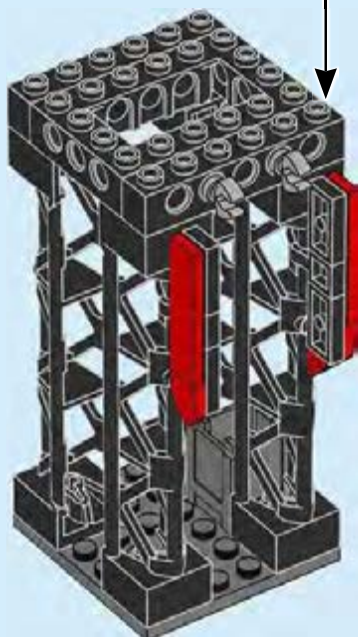
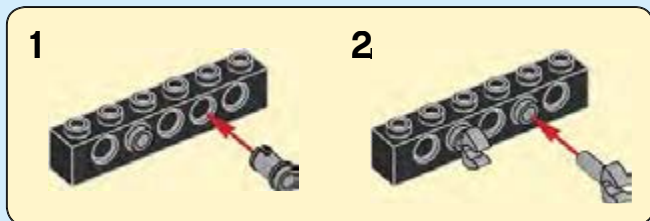

115

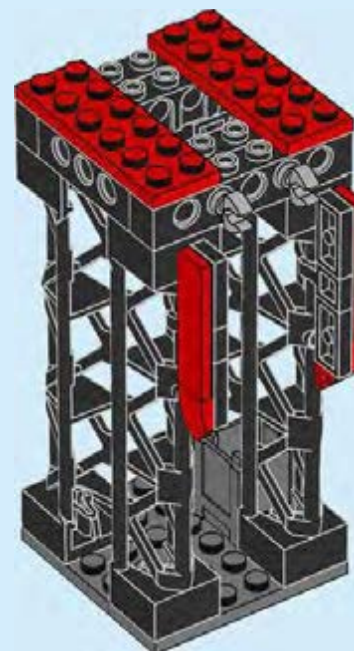

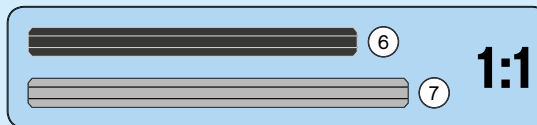
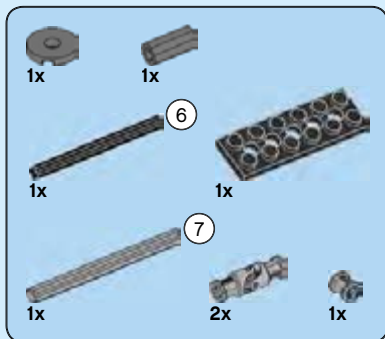

116

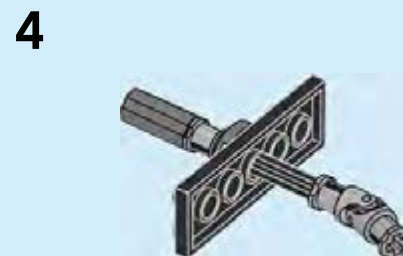
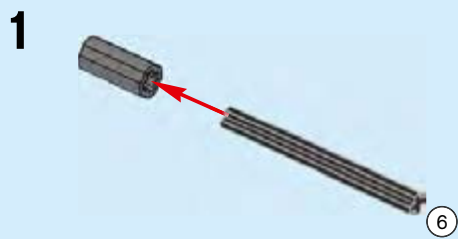

5

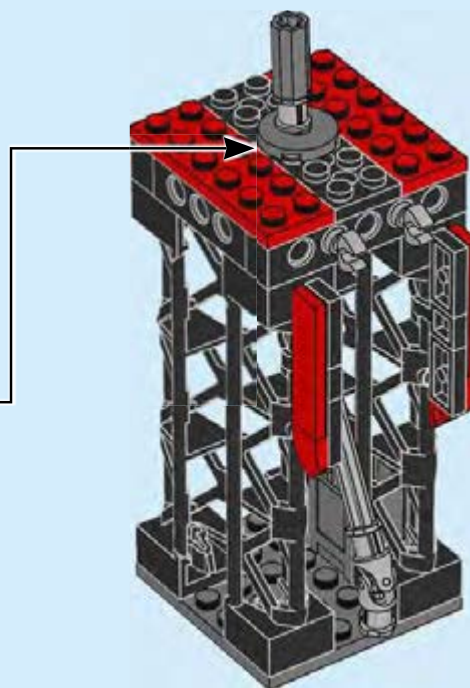
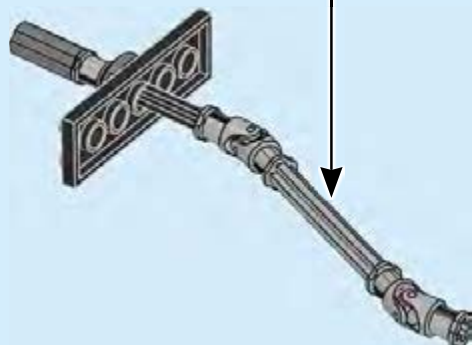
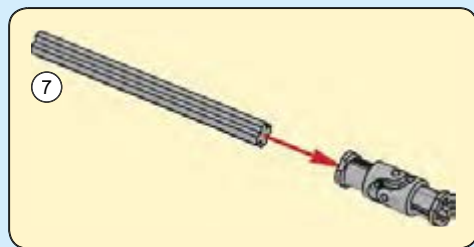



117

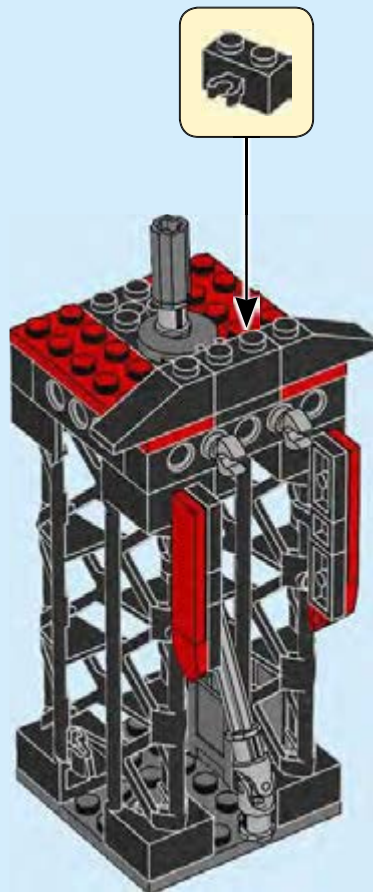



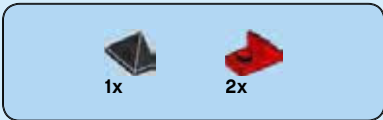

118

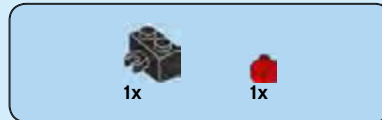
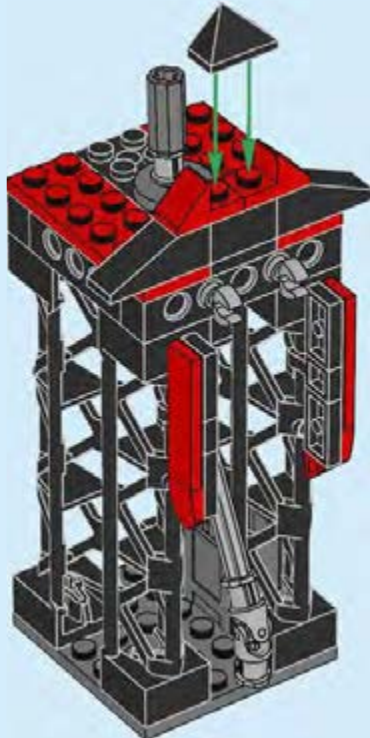

119

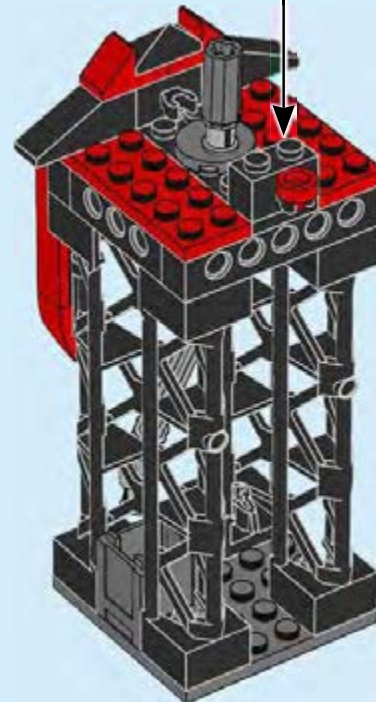
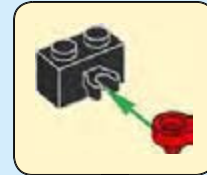



120

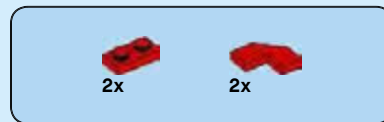
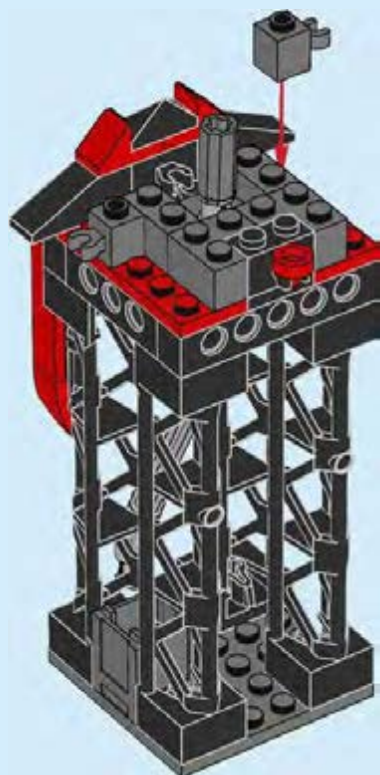

121

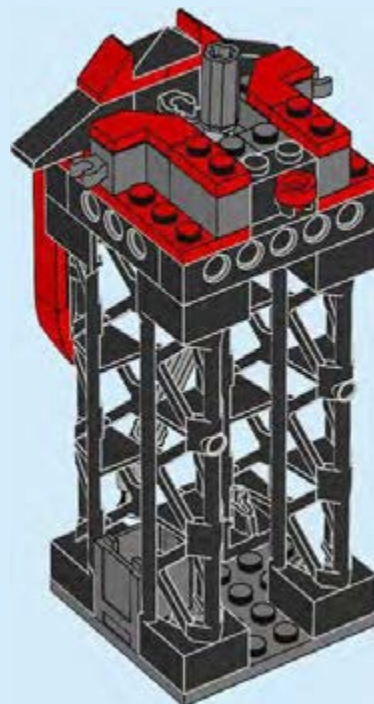



122

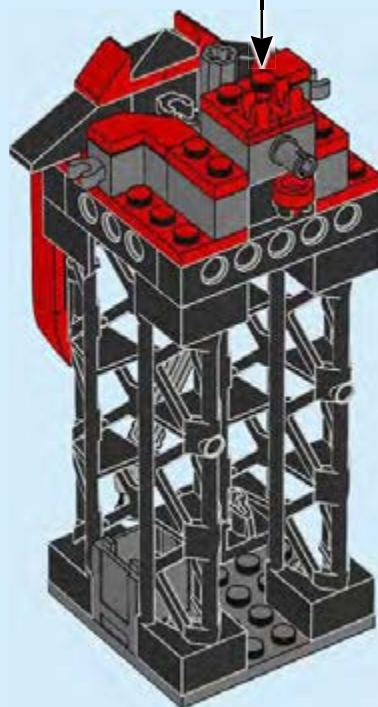
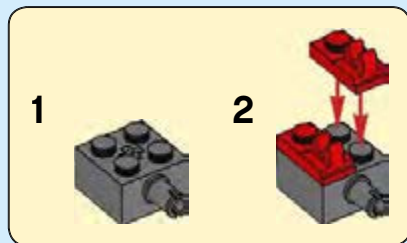

123

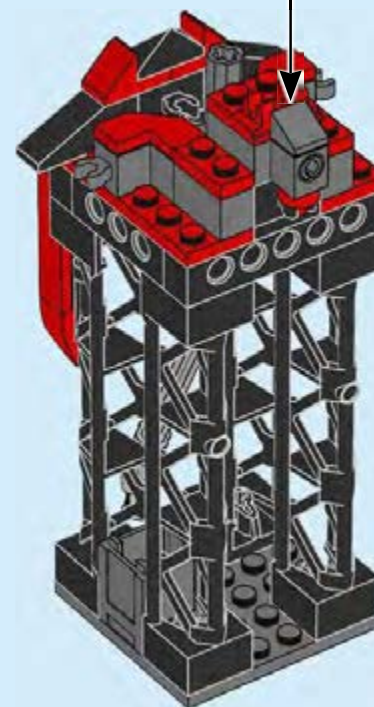

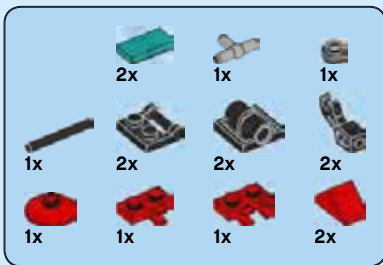

# 124

1



2



3



1



2



4



1



2



3



5

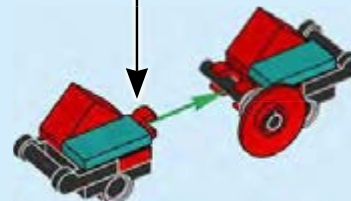



6



7

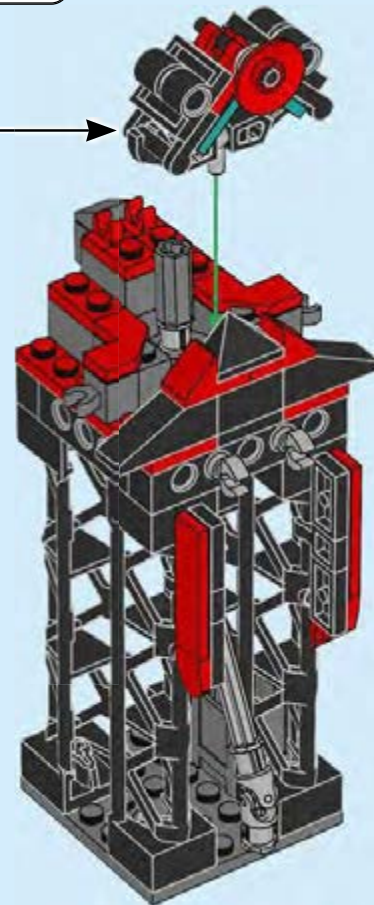

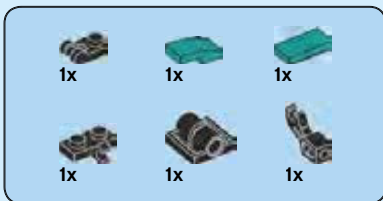

125

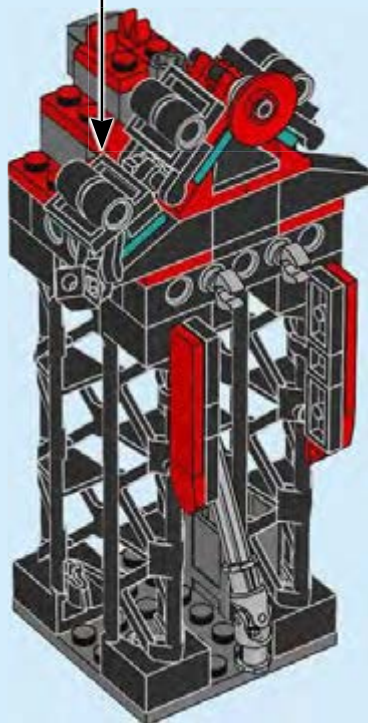

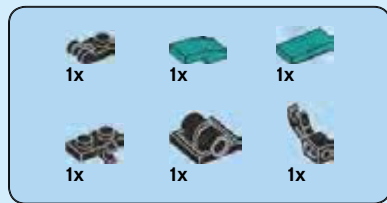

126

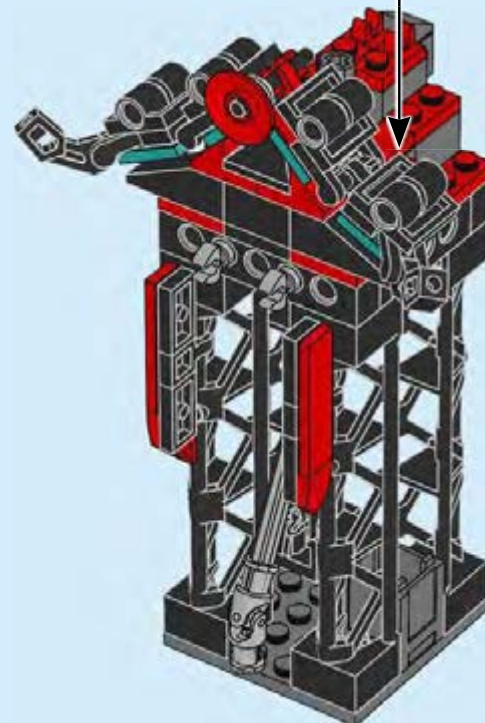



127

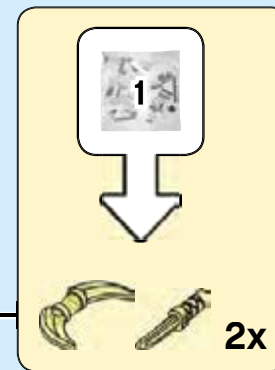
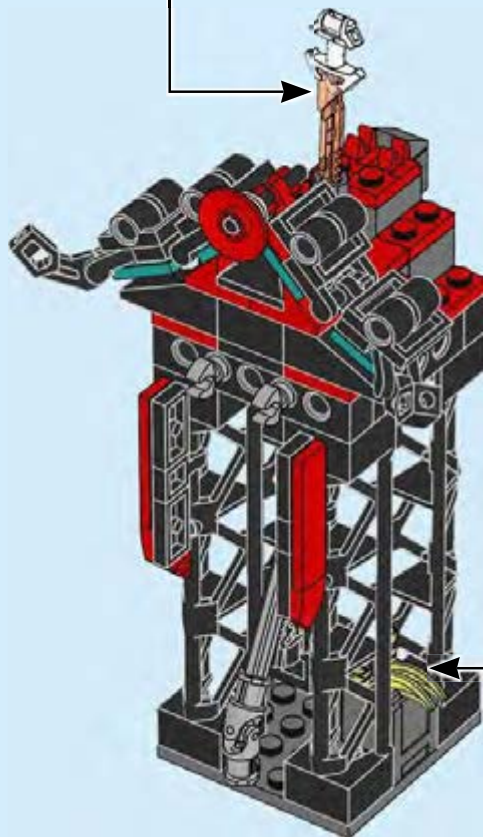



128

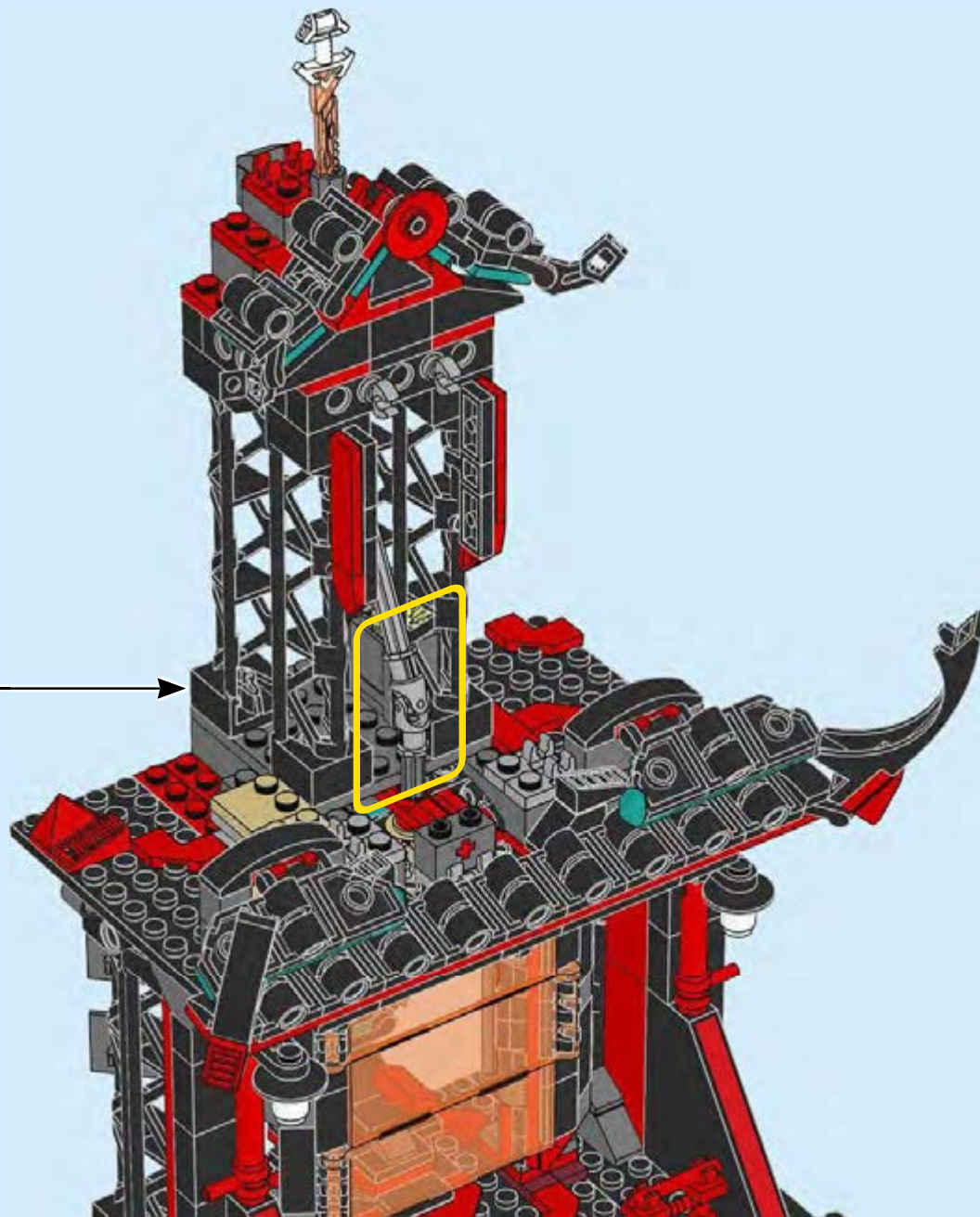

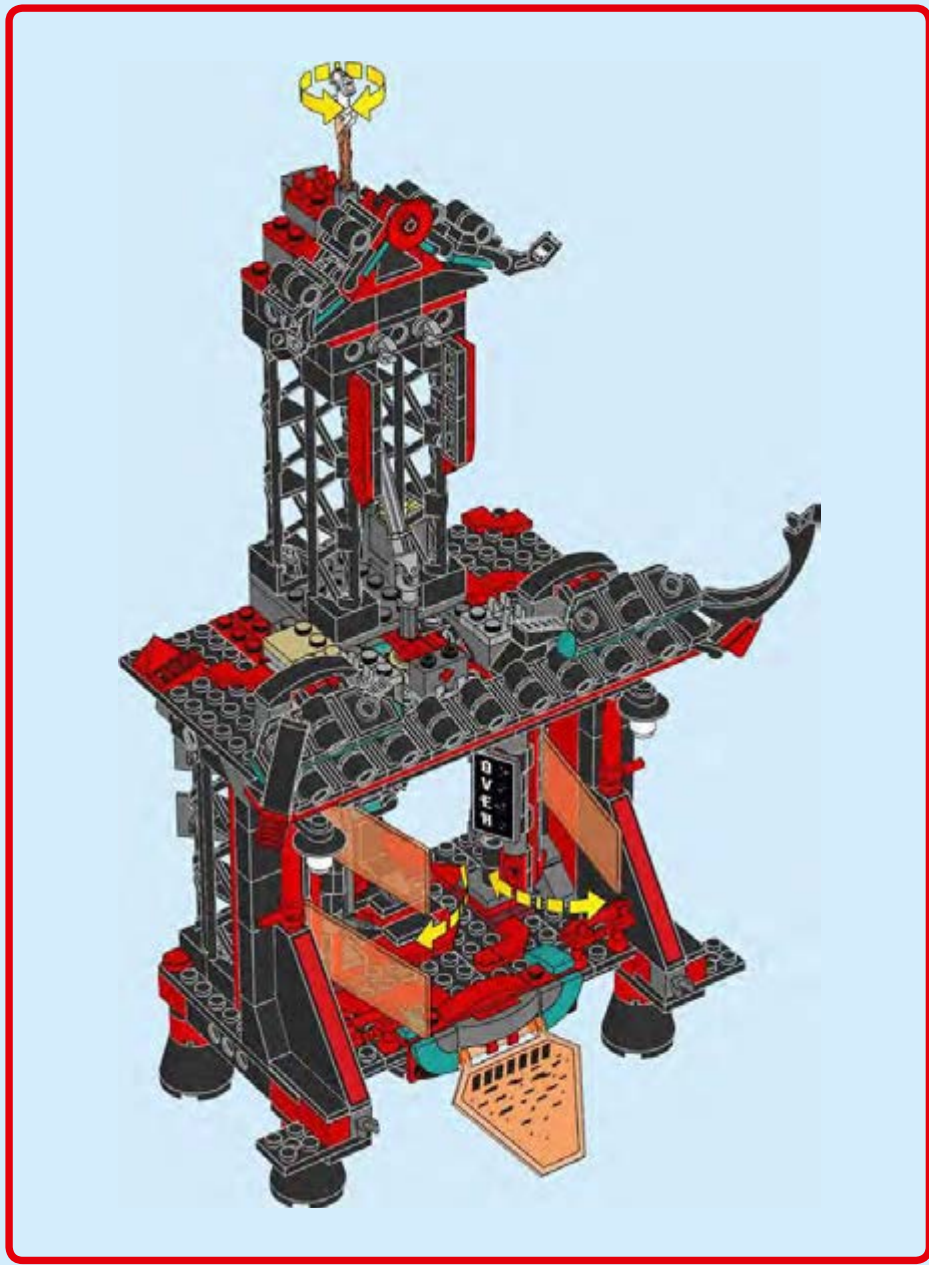

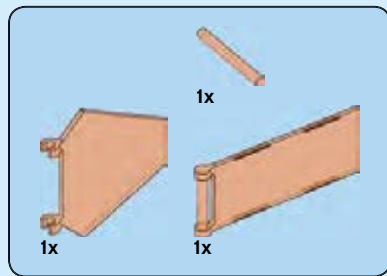

129

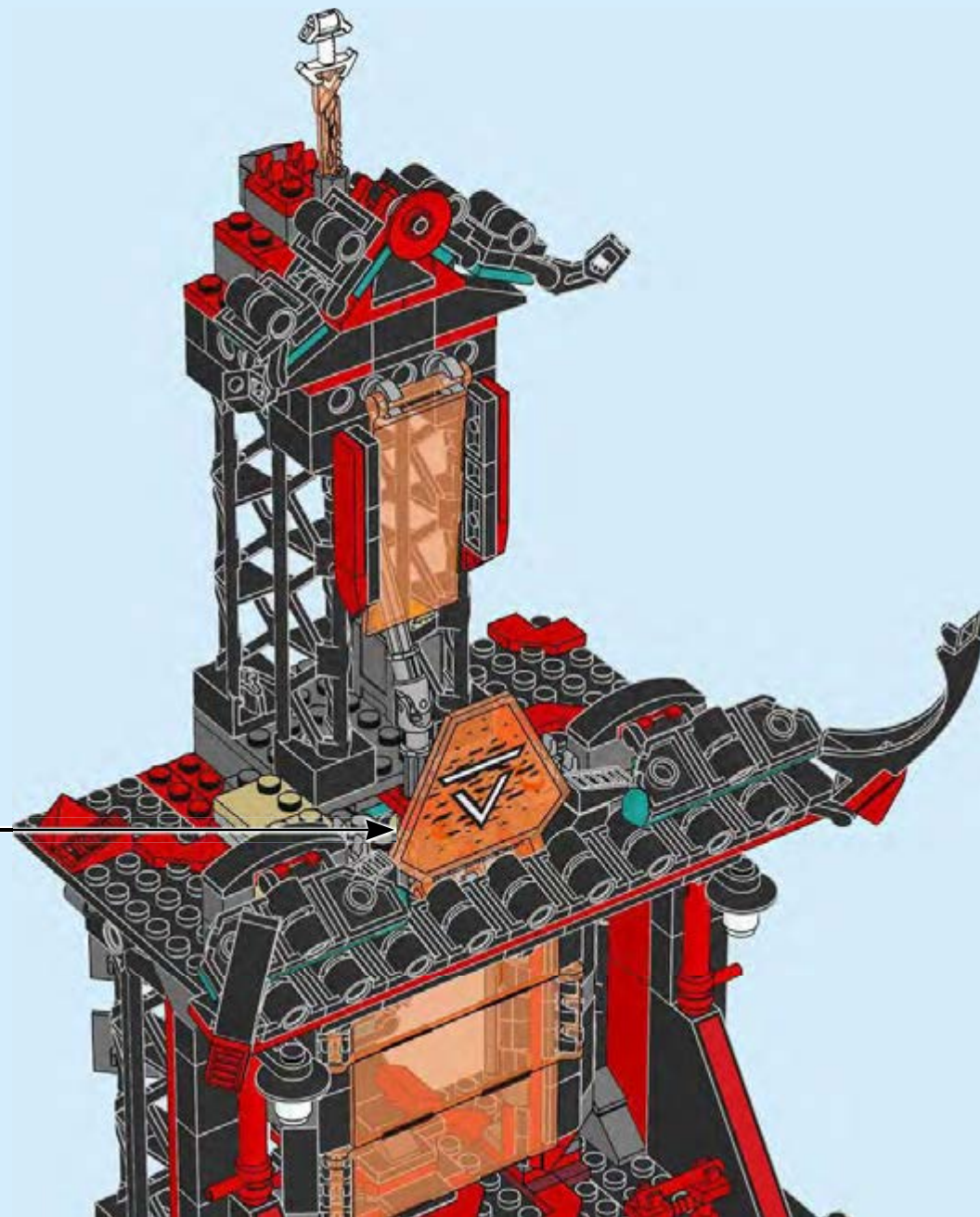
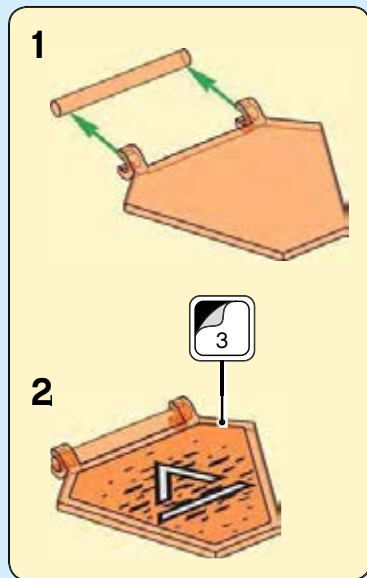

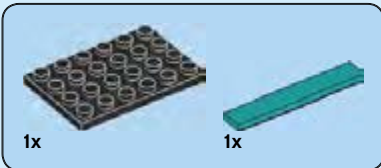

130

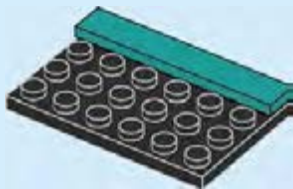

131



132

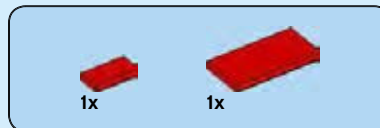

133

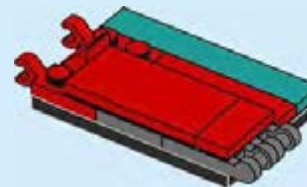





134



135

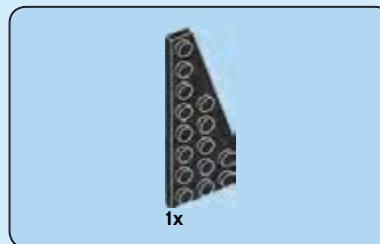
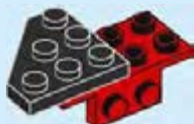

136

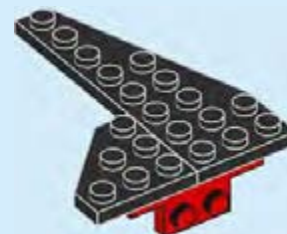

137



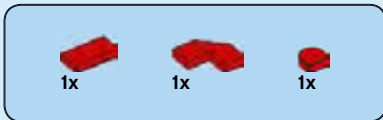

138

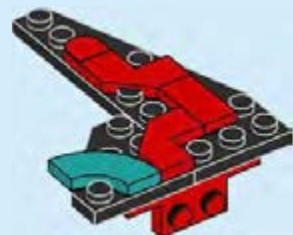

139

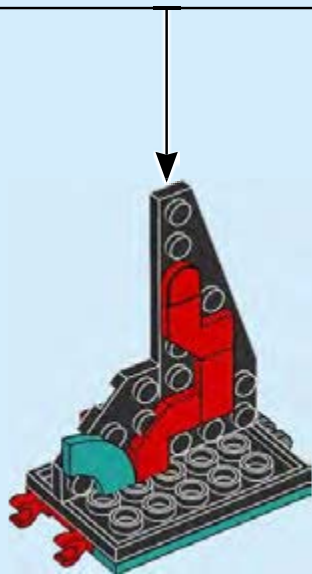

100



140





141

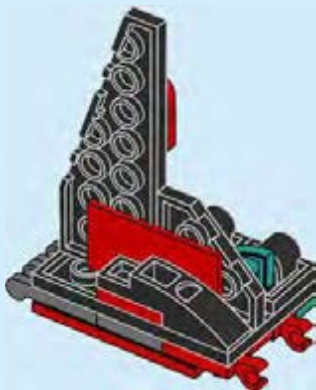

142

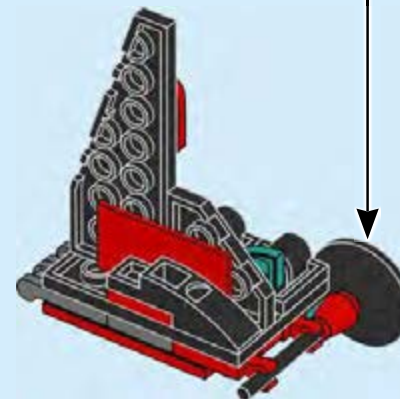
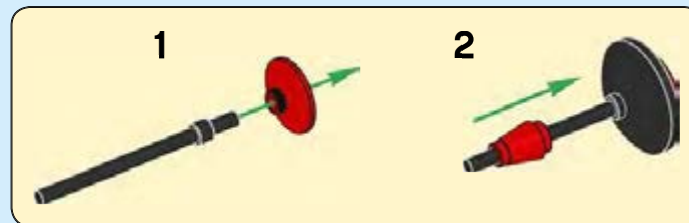

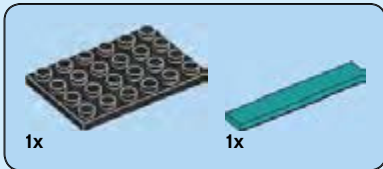

143

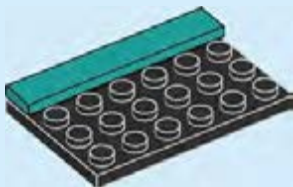

144



145

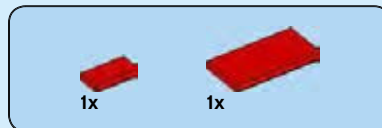
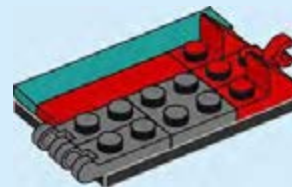

146

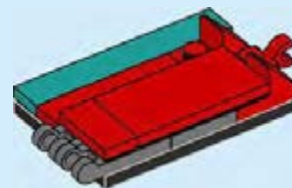





147

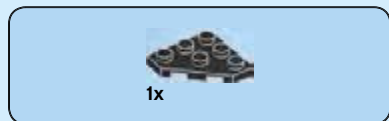

148



149



150

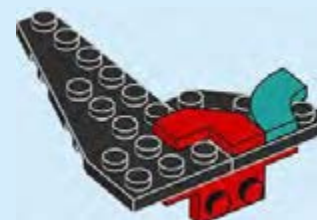

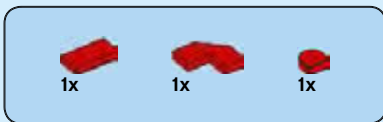

151



152

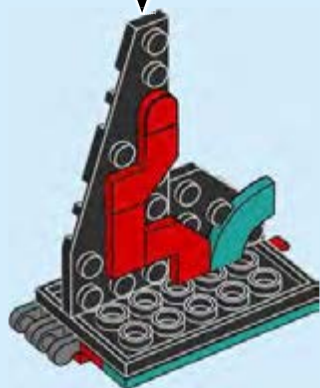

153

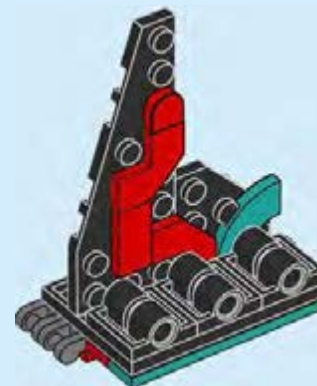

154



155

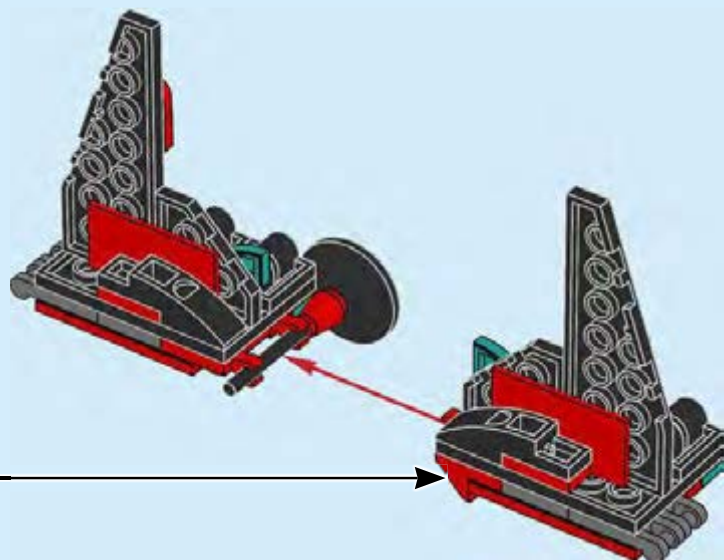

156

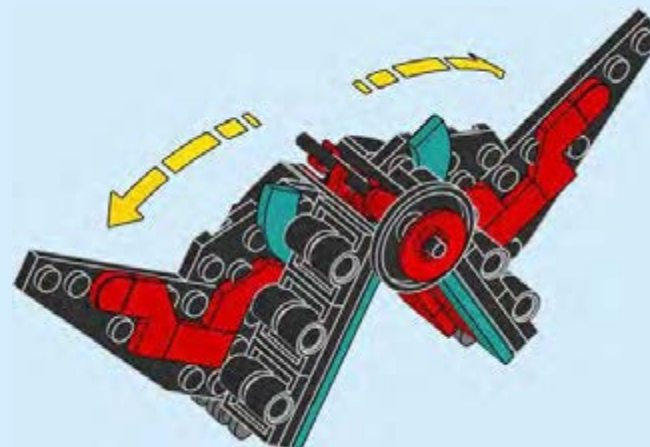

157

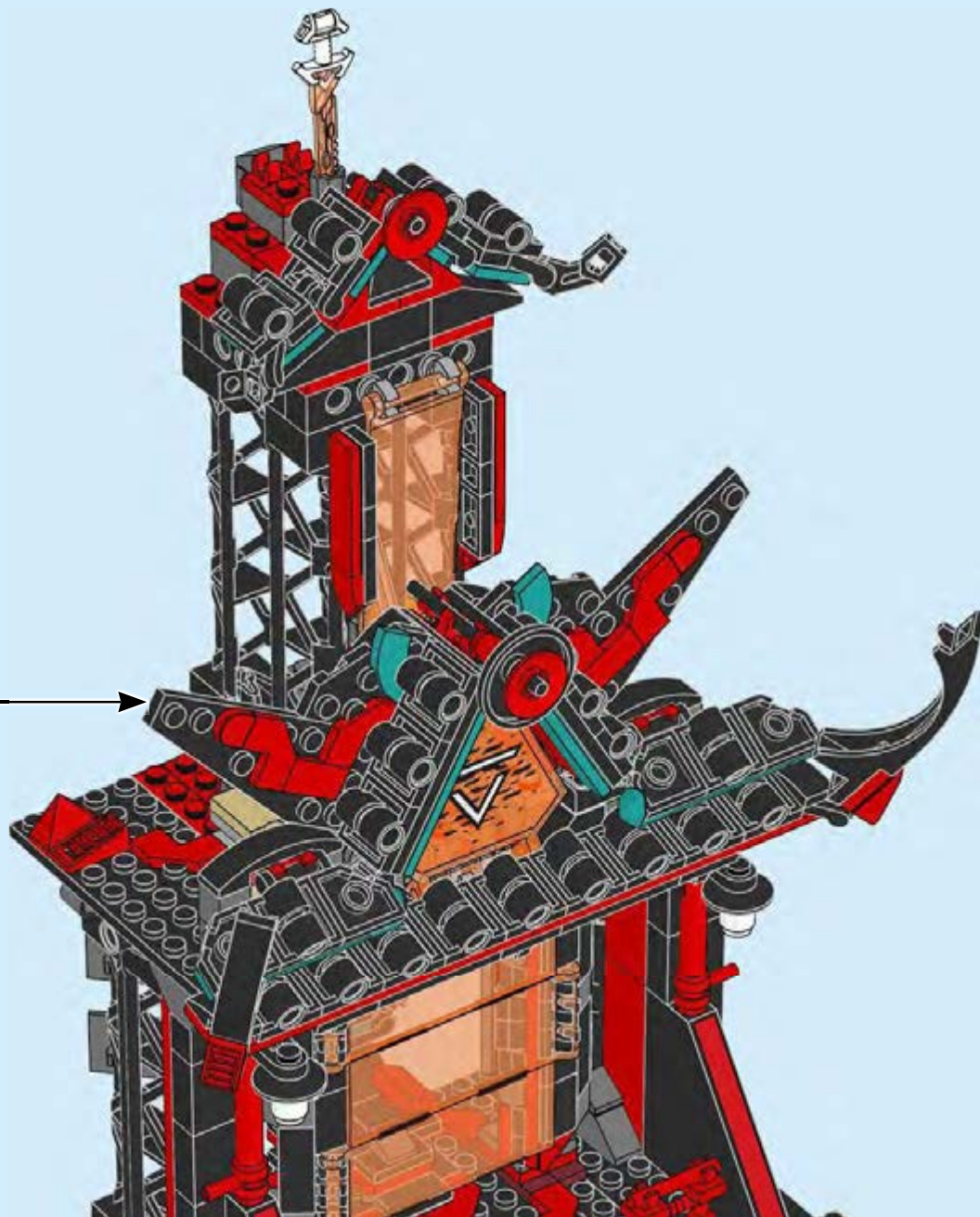

106





158

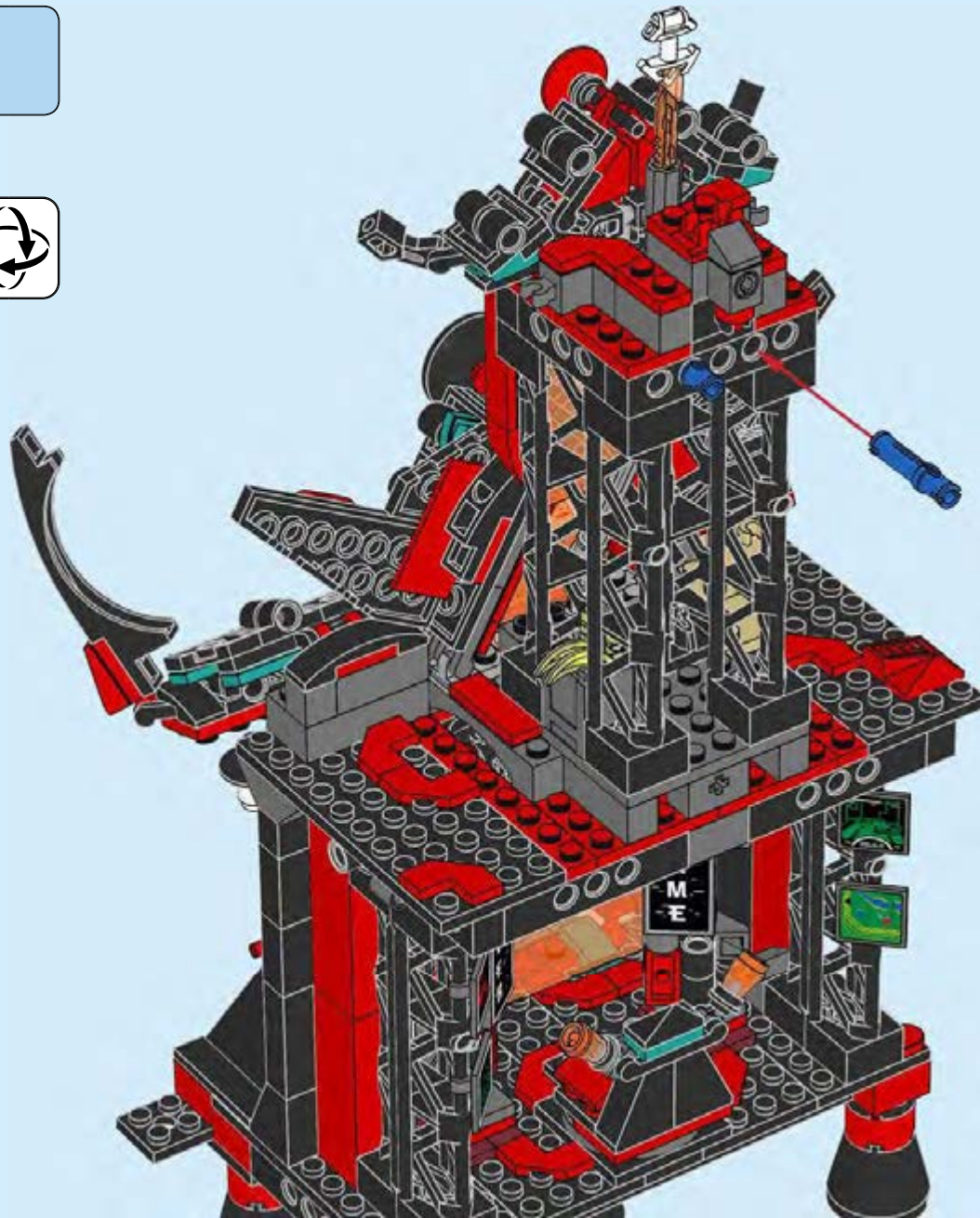

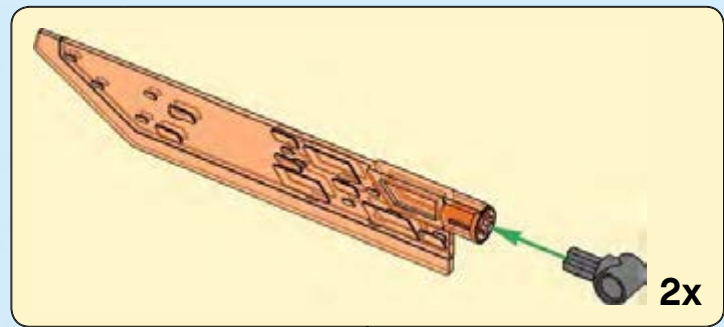
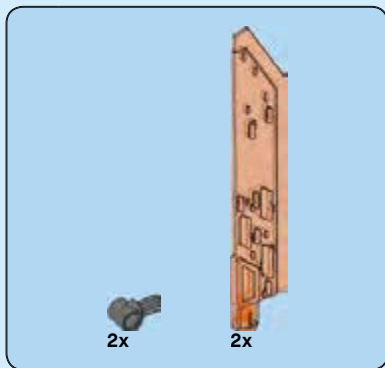

159

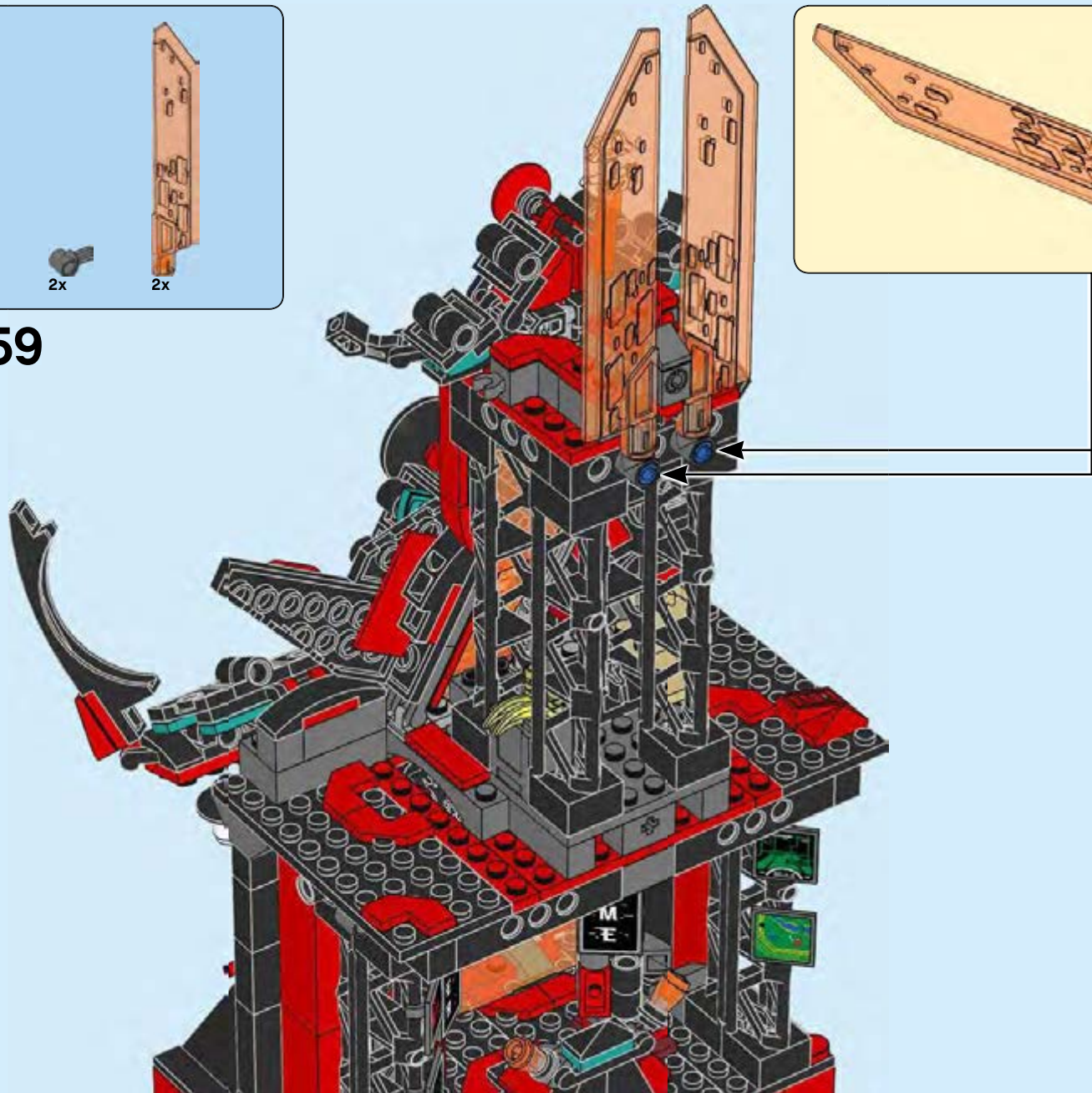

108



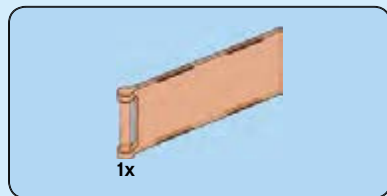

160

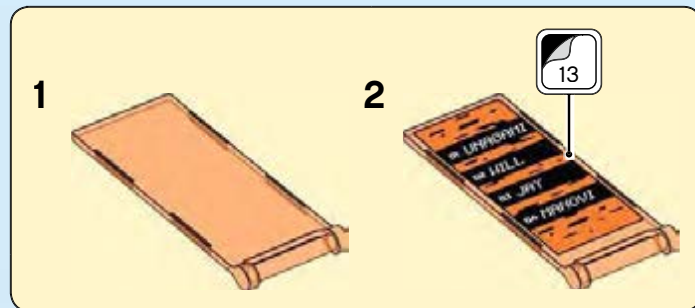
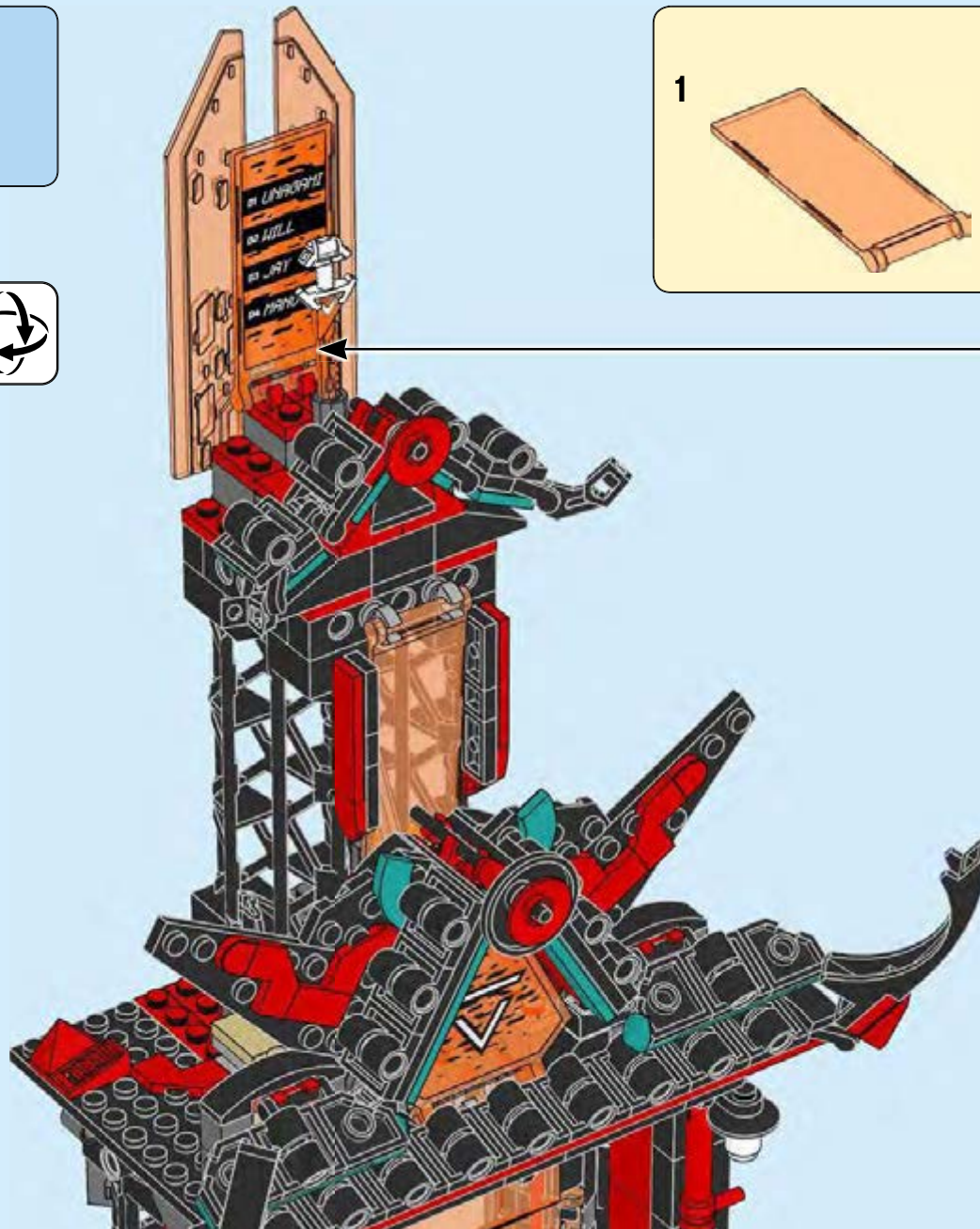

5

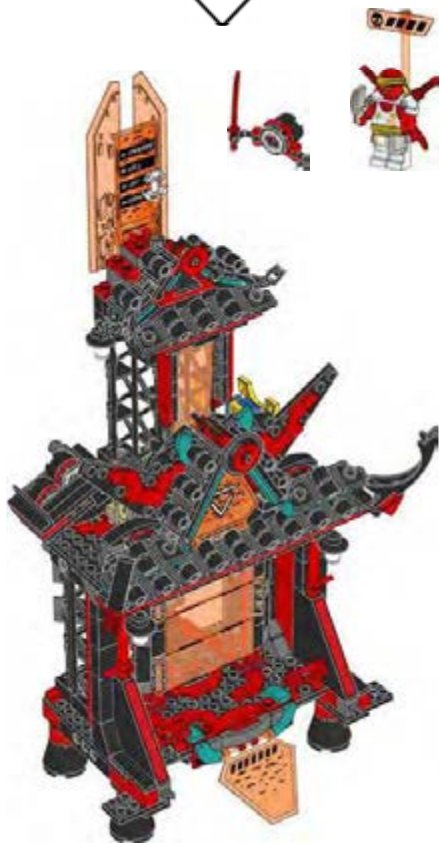

1x



1x



1x



1x



1x

1

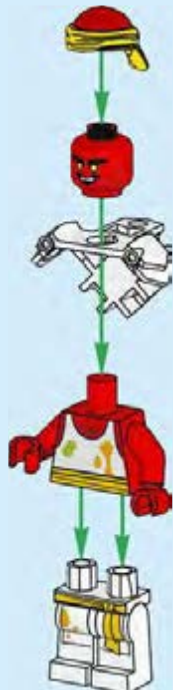

2x



1x



1x

2

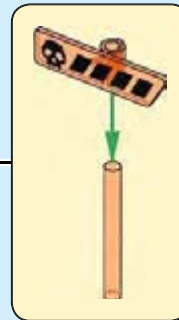

2x

3





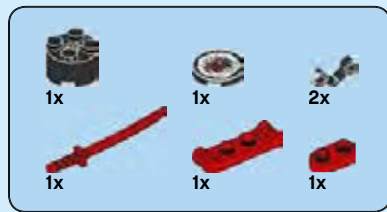

1



2



3



4



5





161

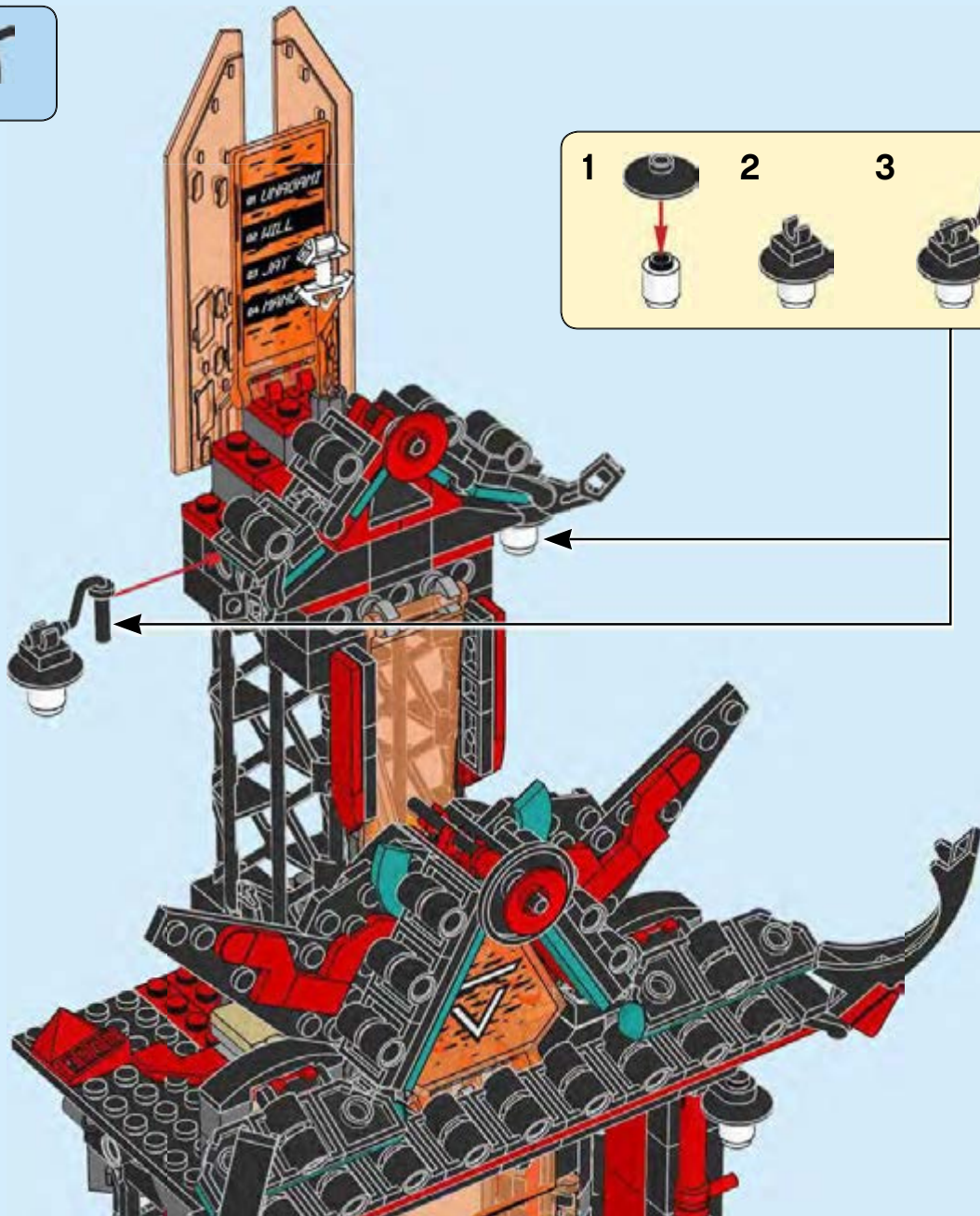

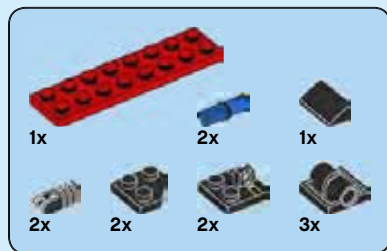

162

1

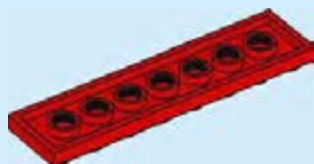

2



3



4



5

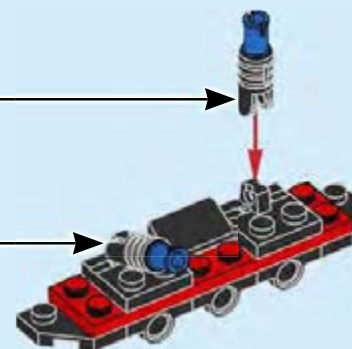

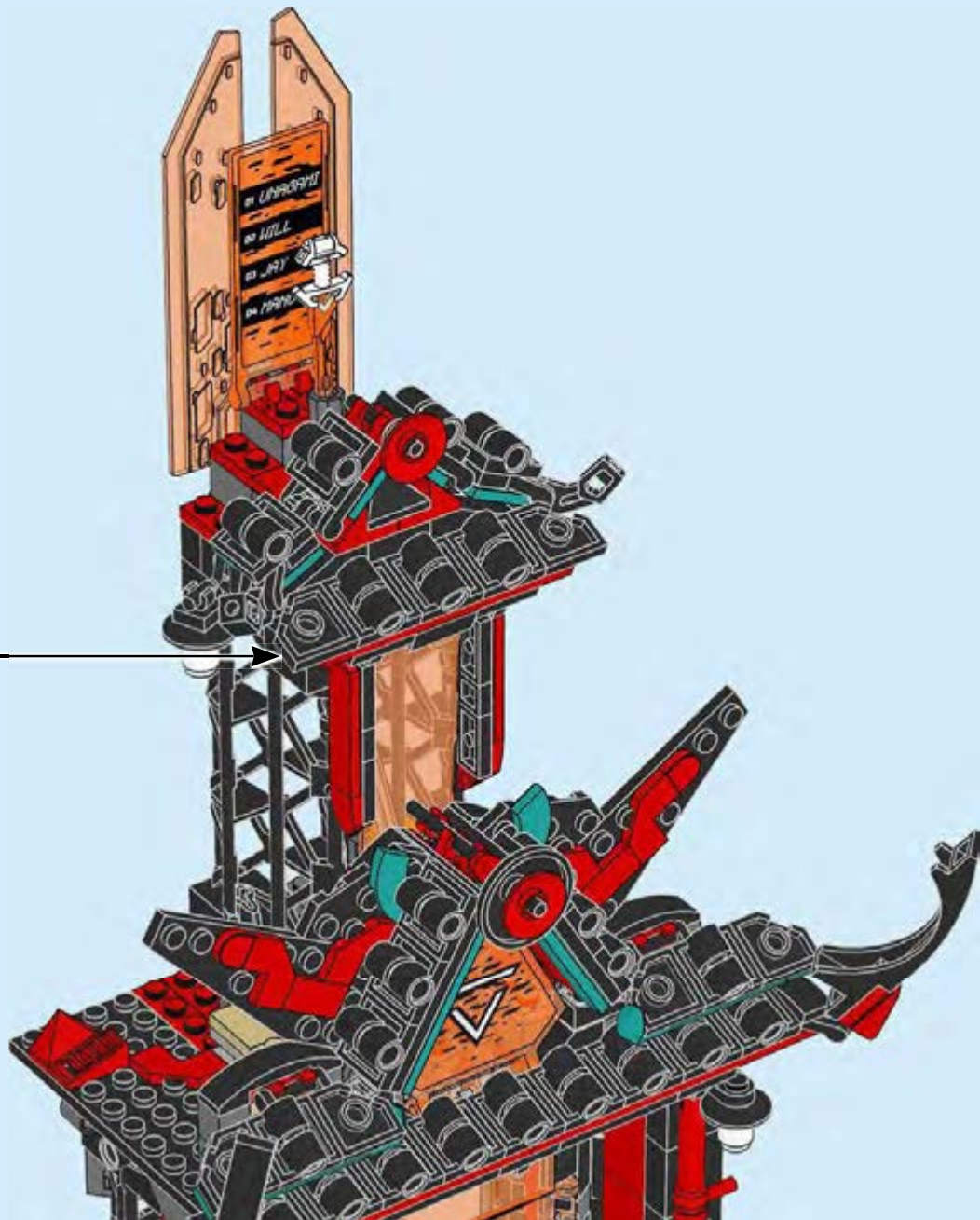





163

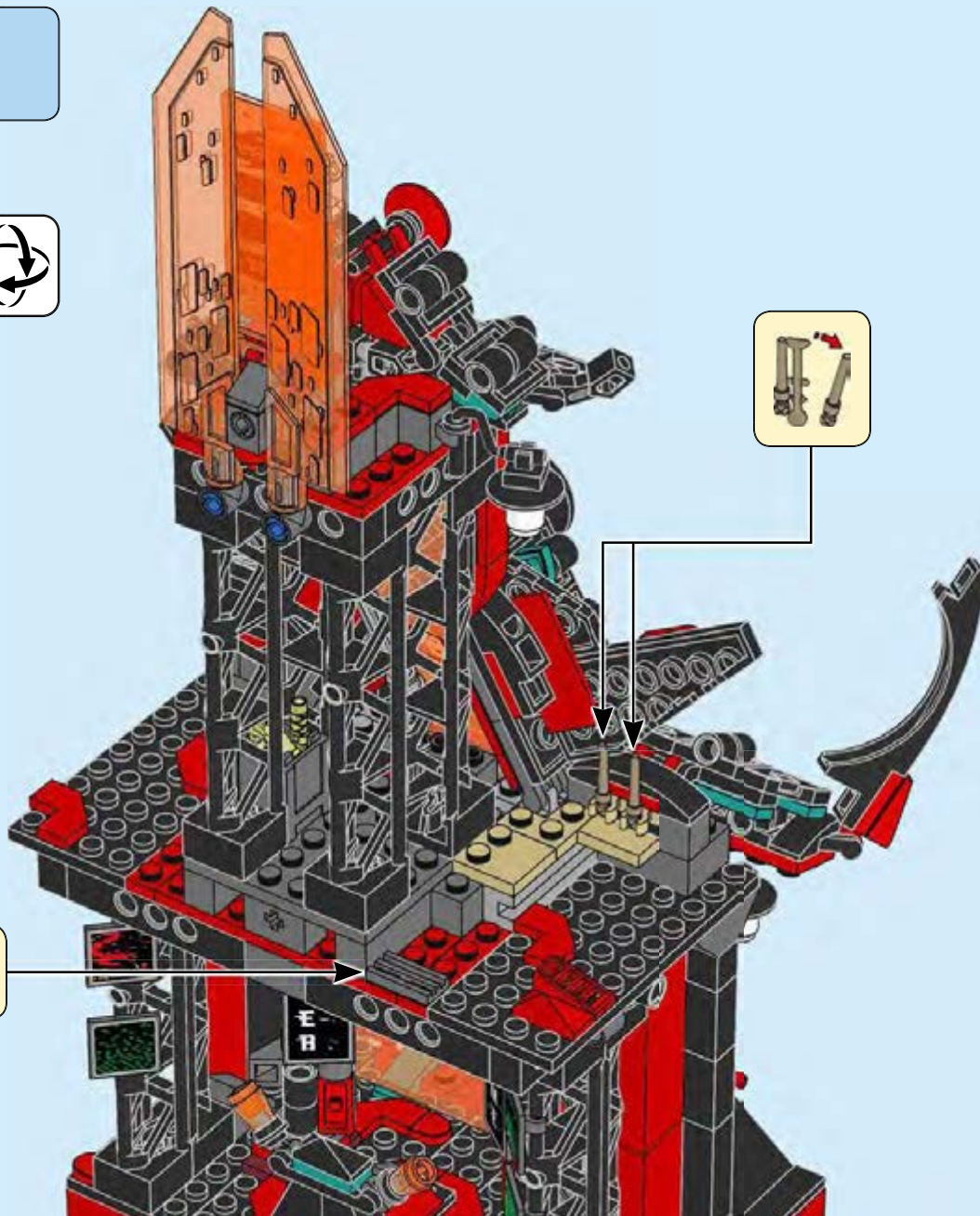



164

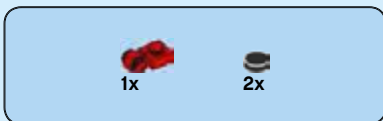

165

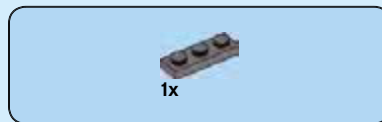

166

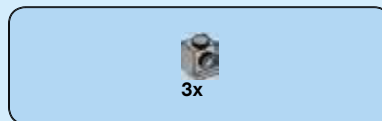

167





168

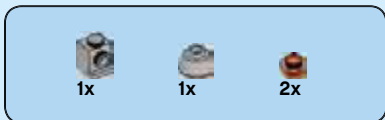
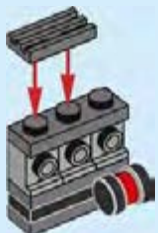

169

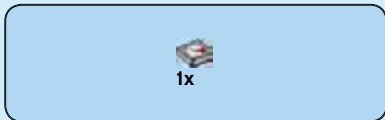

170

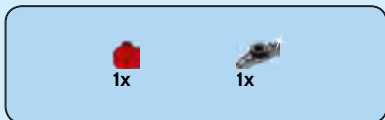

171



172

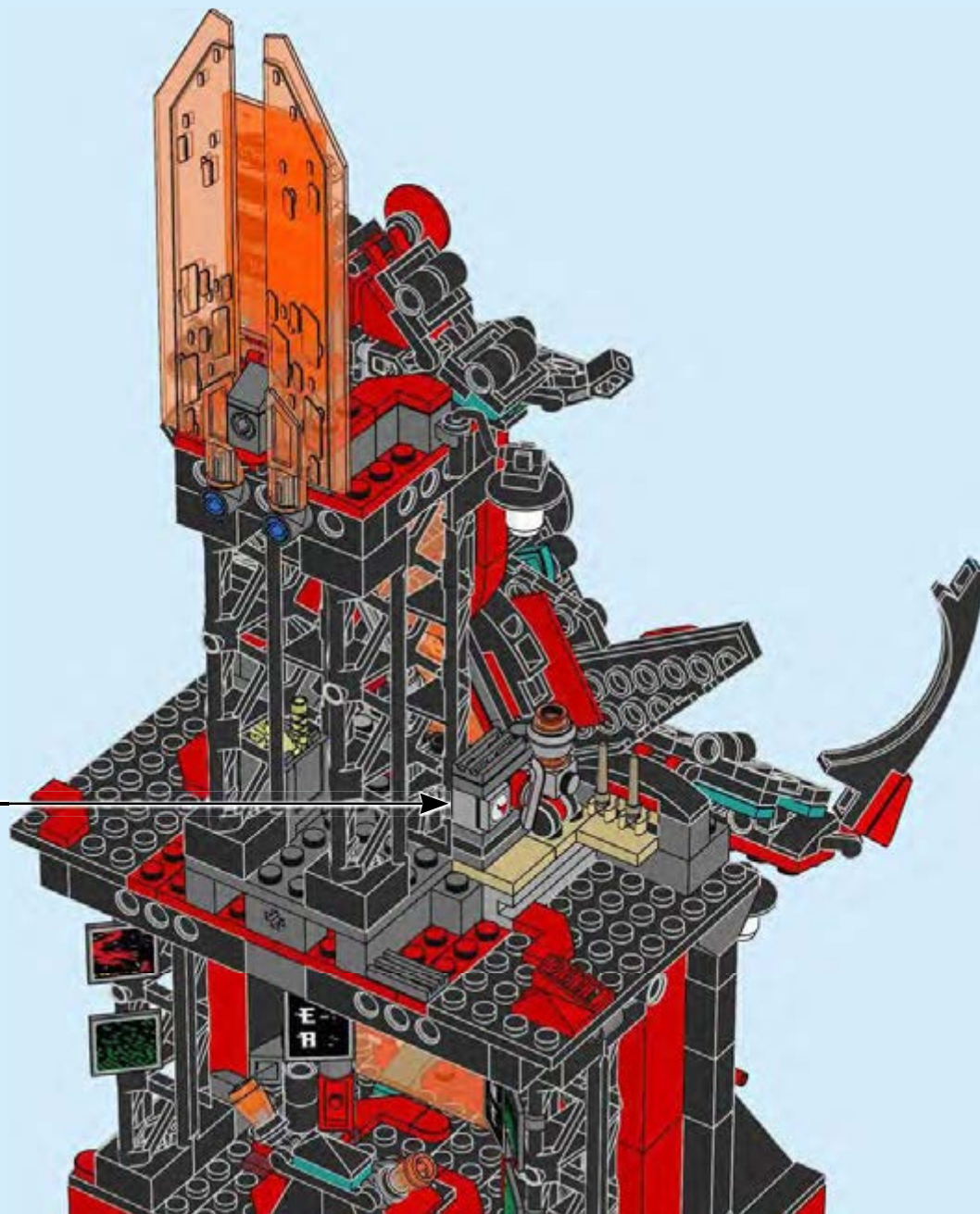

118



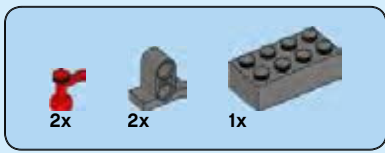

173

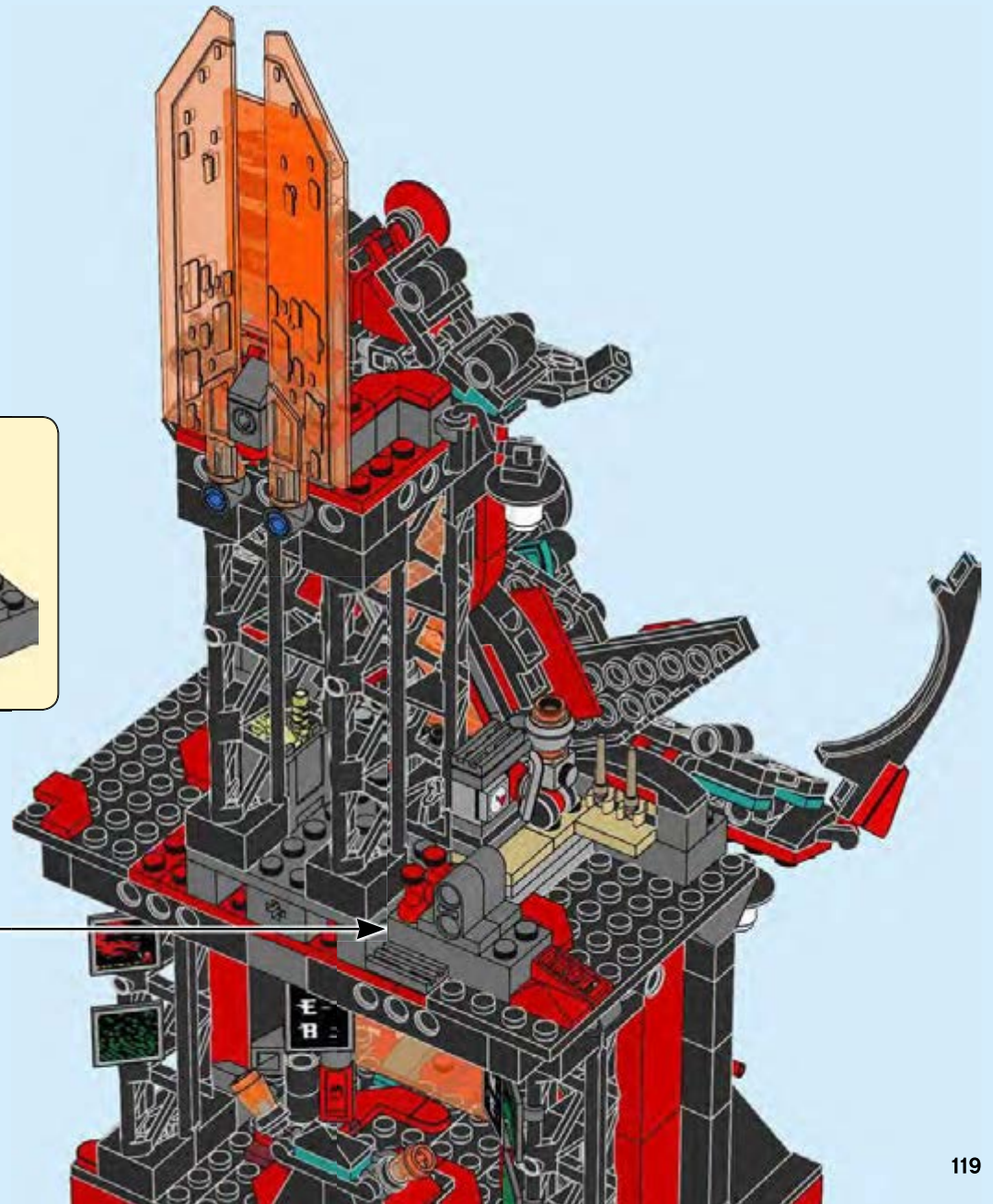
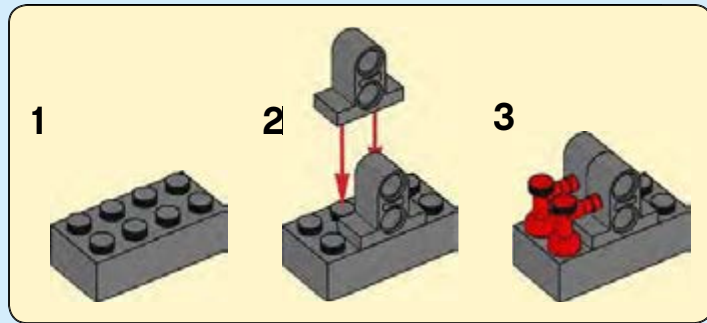



174

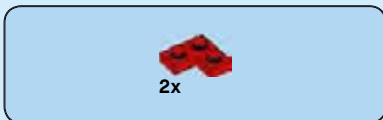

175

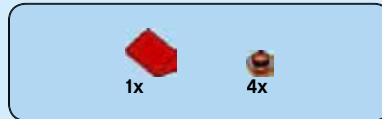

176



177

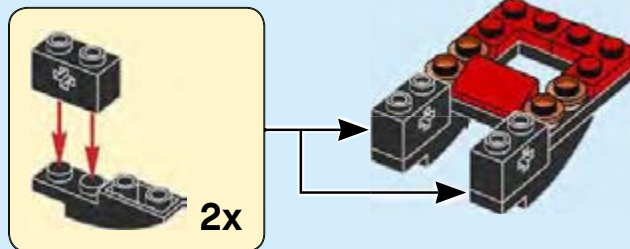



178

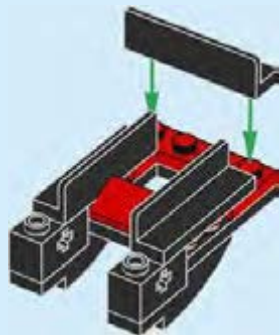

179

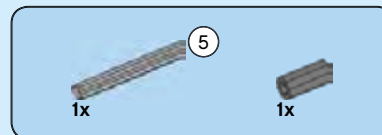
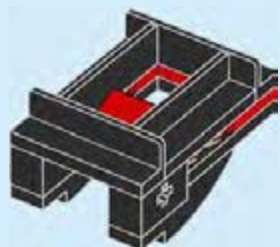

180

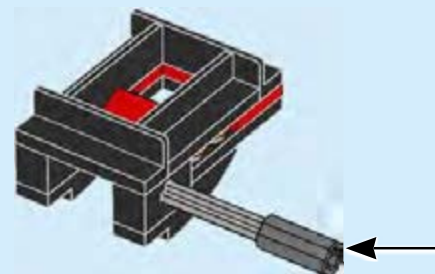
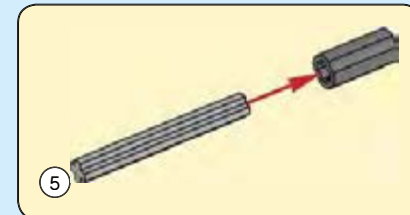

181

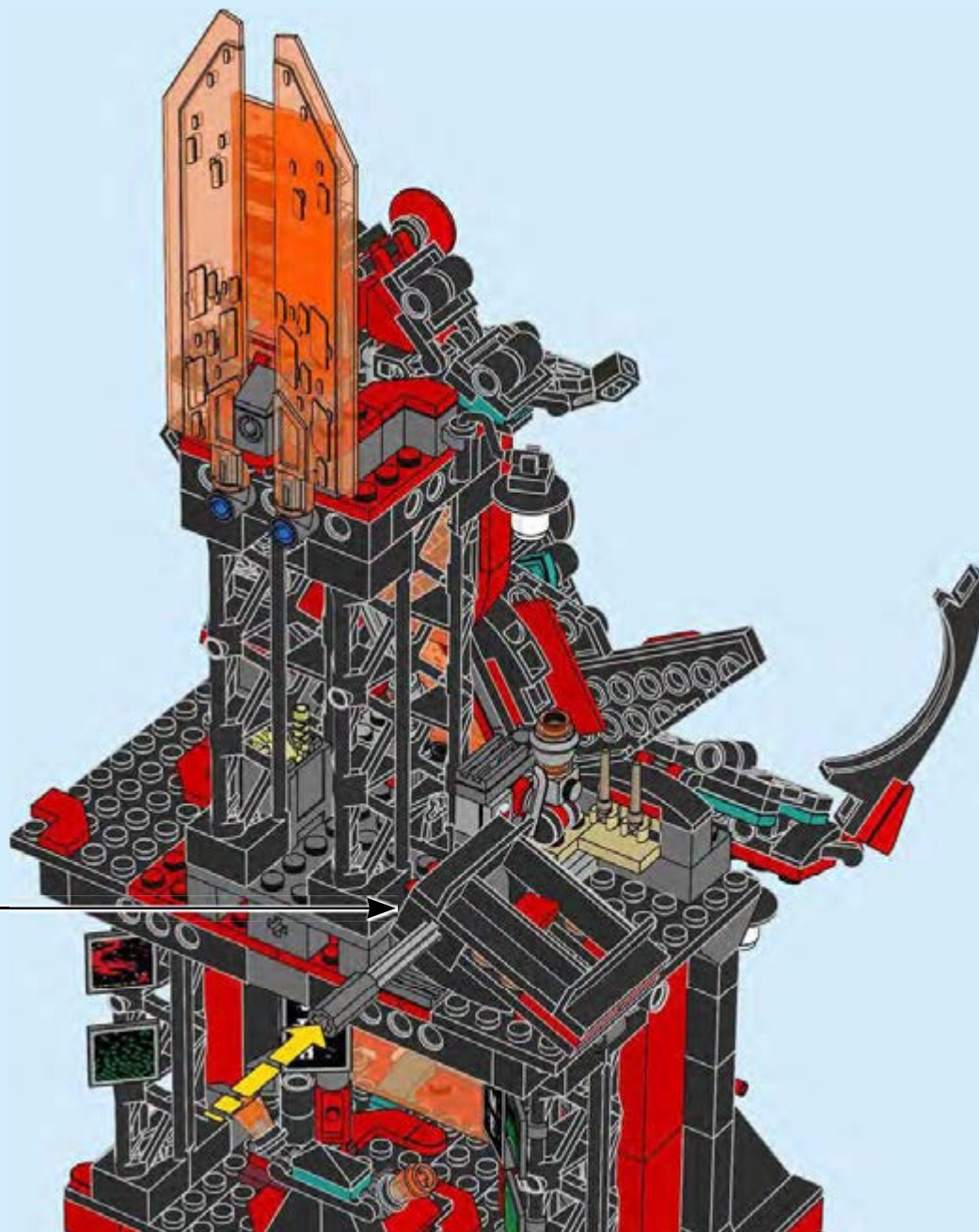

122



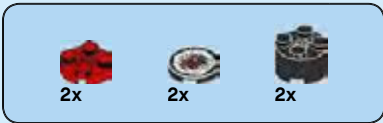

182

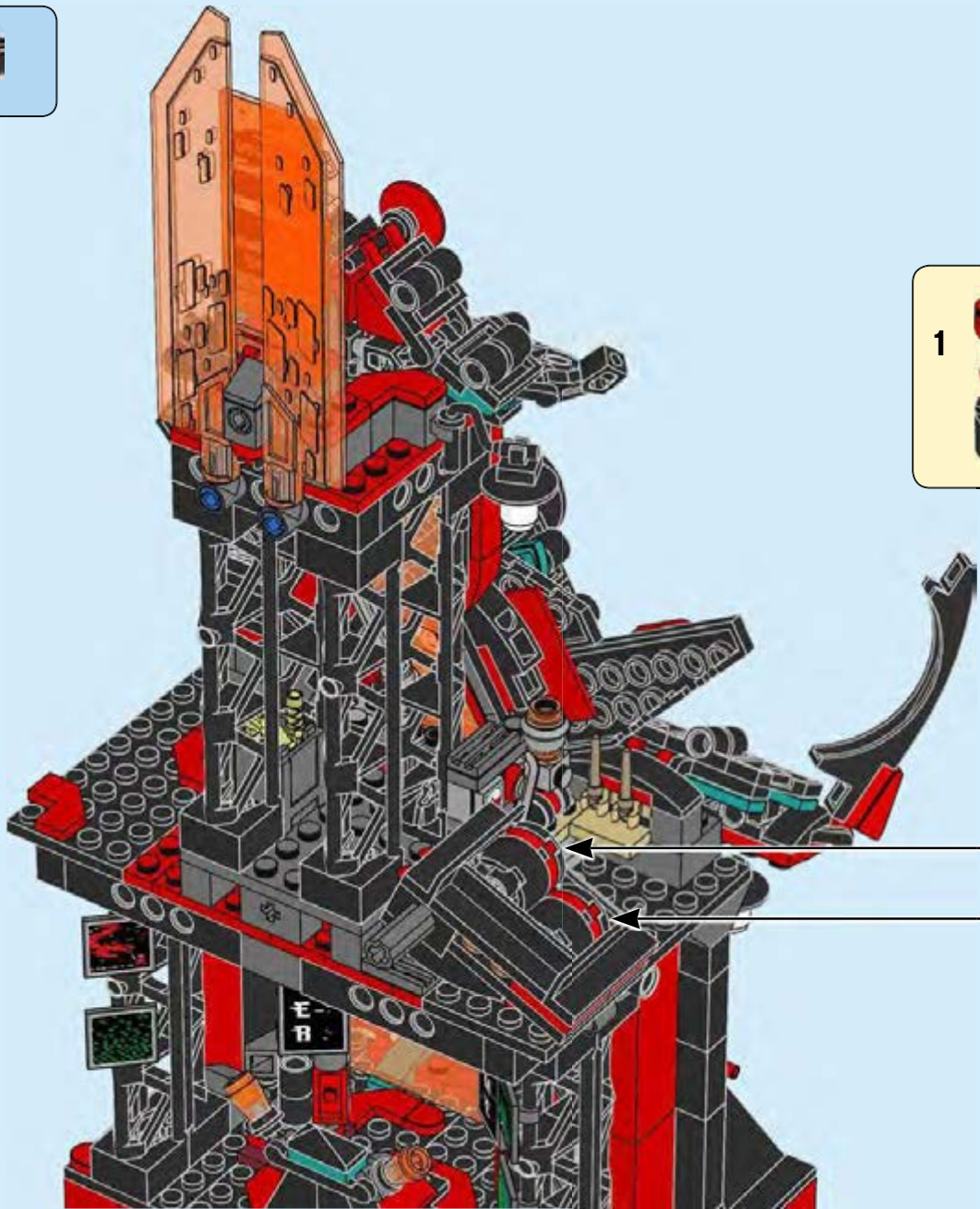

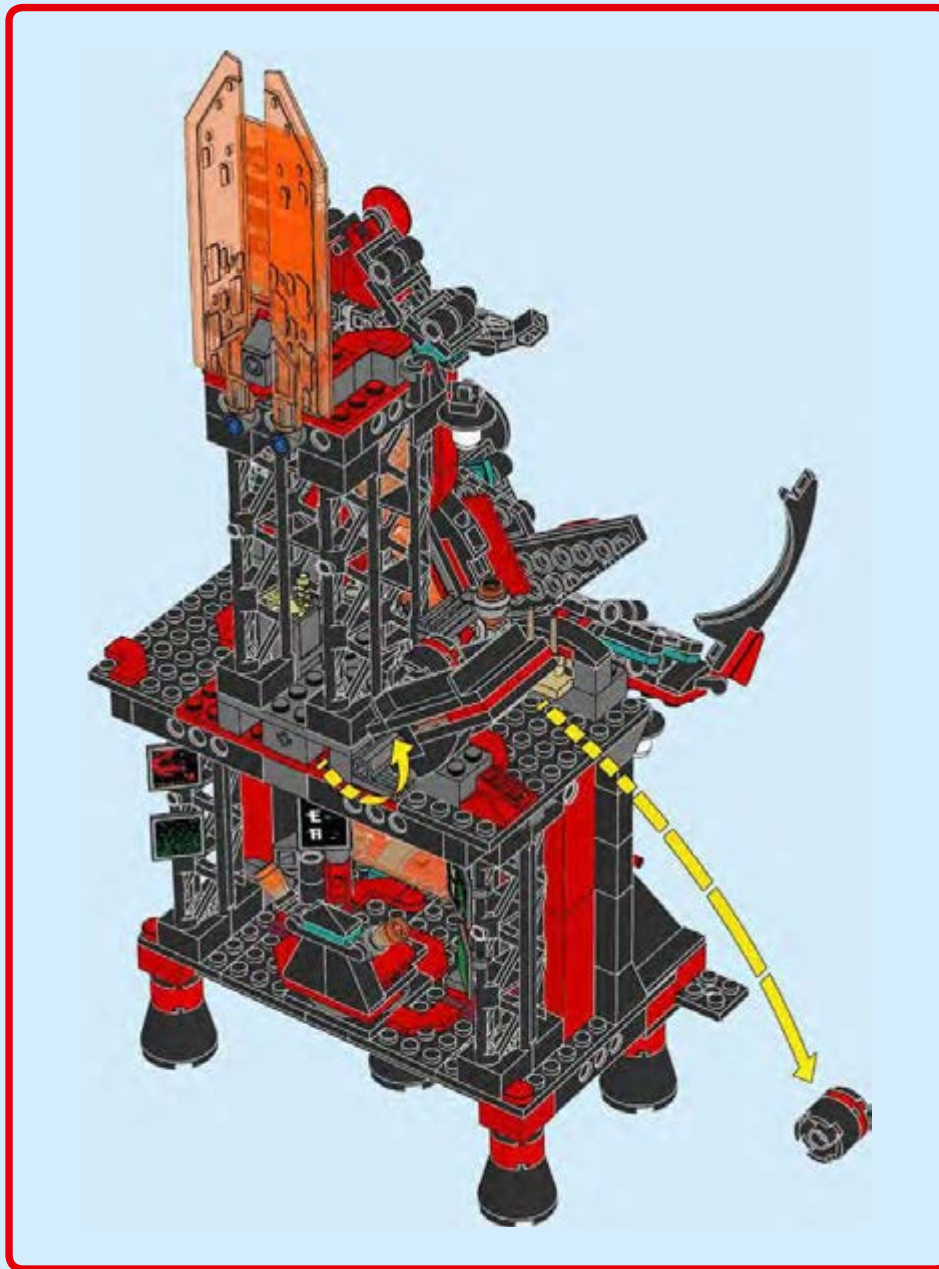



183

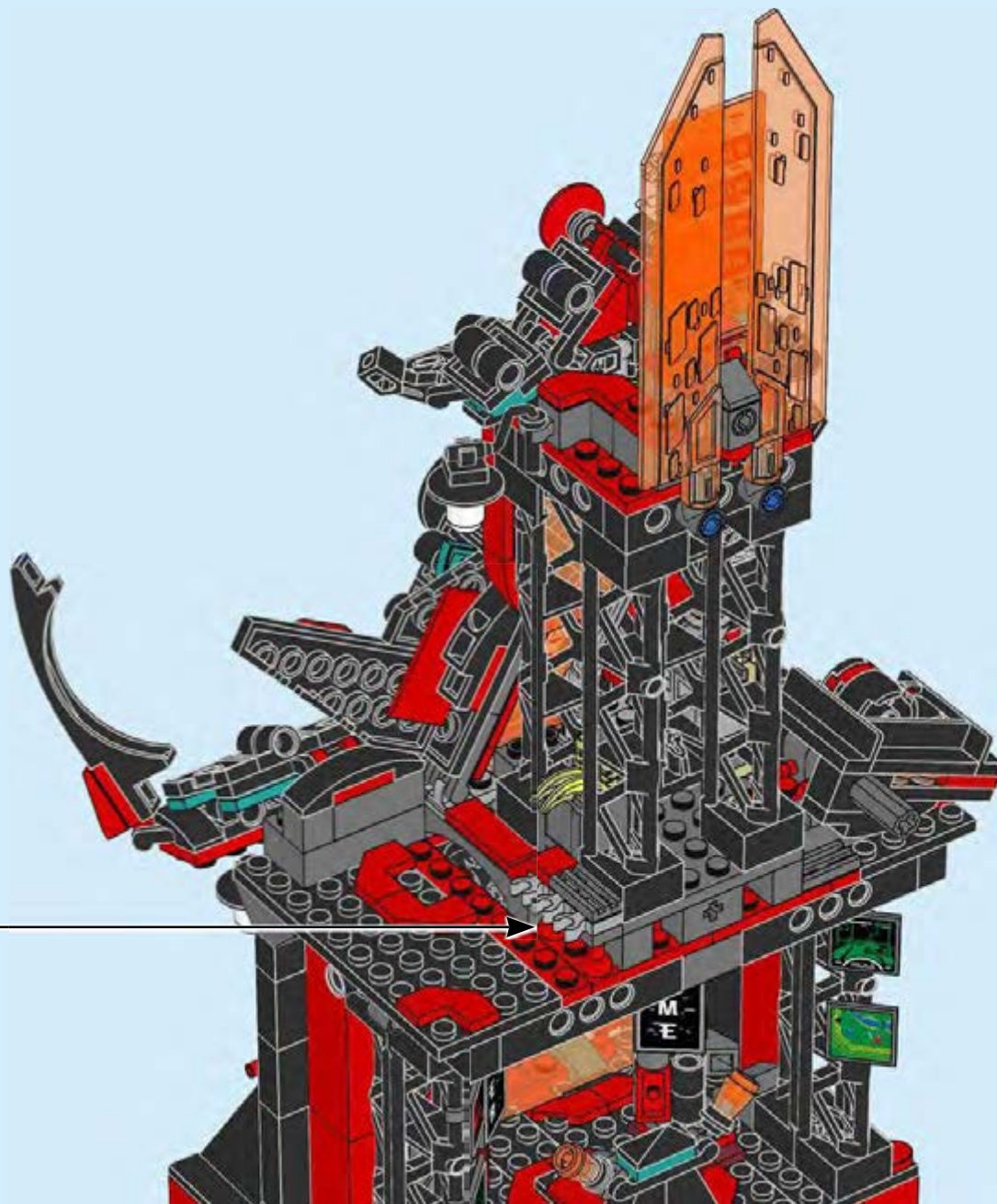
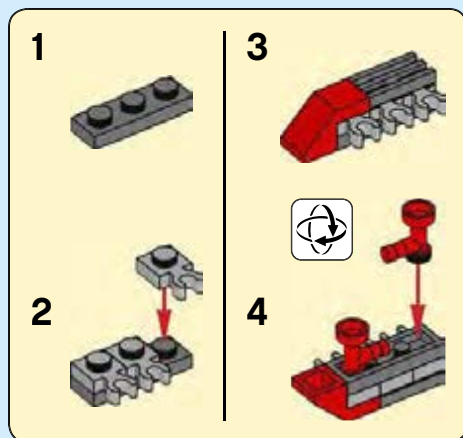





3x

# 184

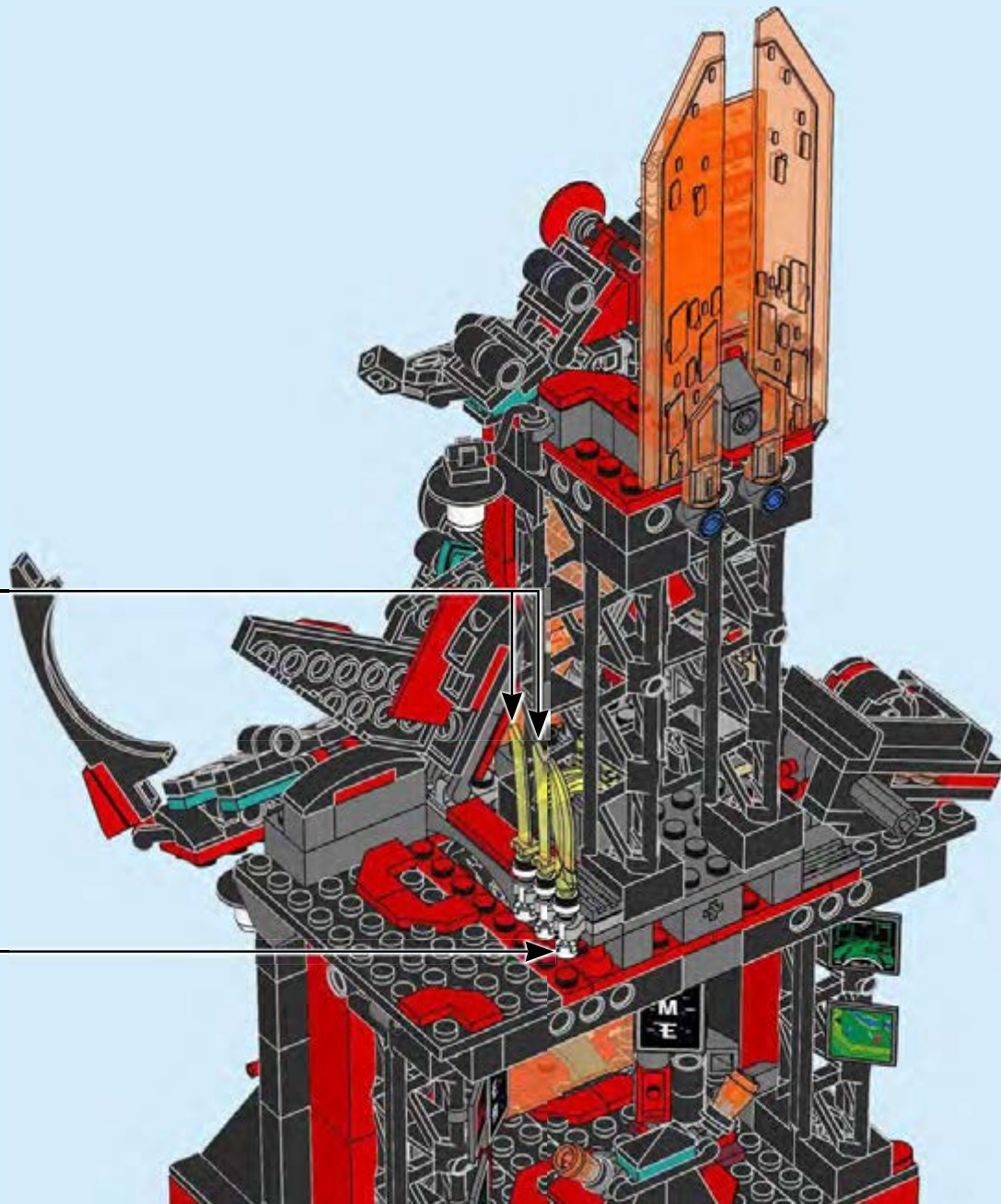
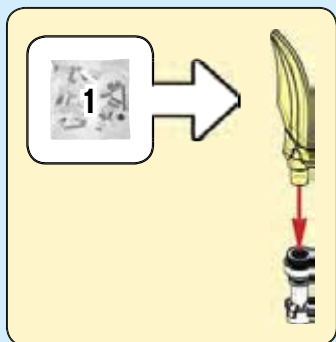
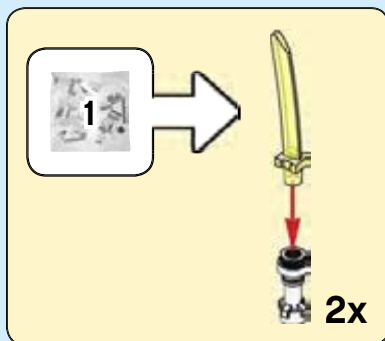

126





185



186



187

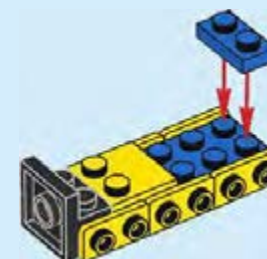



188



189

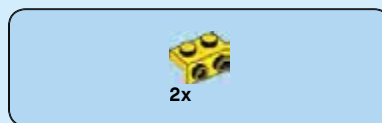

190



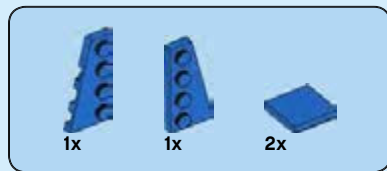

191



192

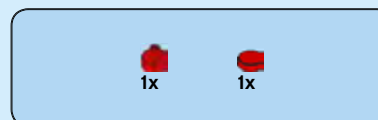
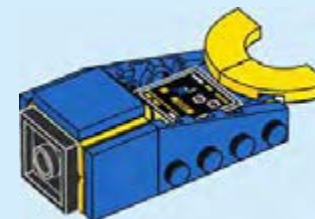

193



194

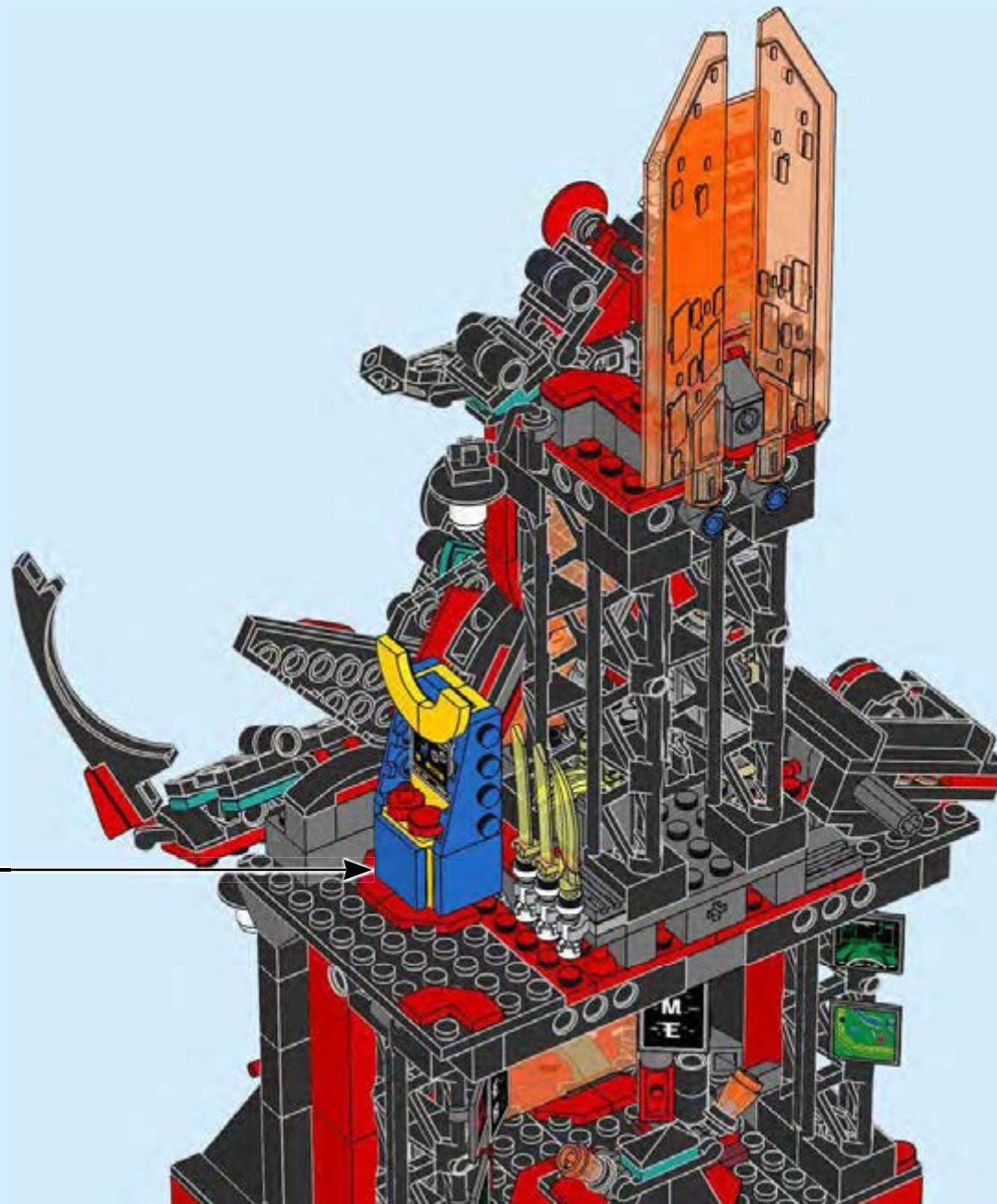

130





1



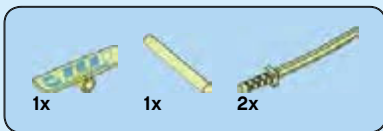

2

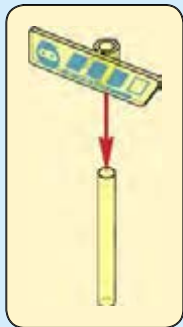

3

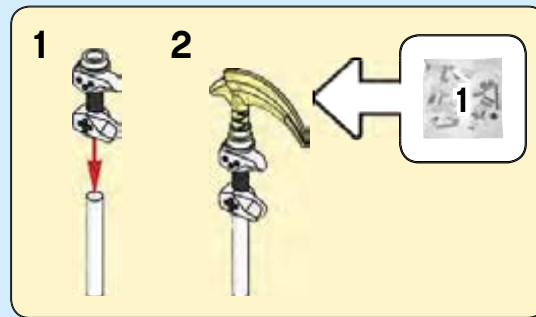



195

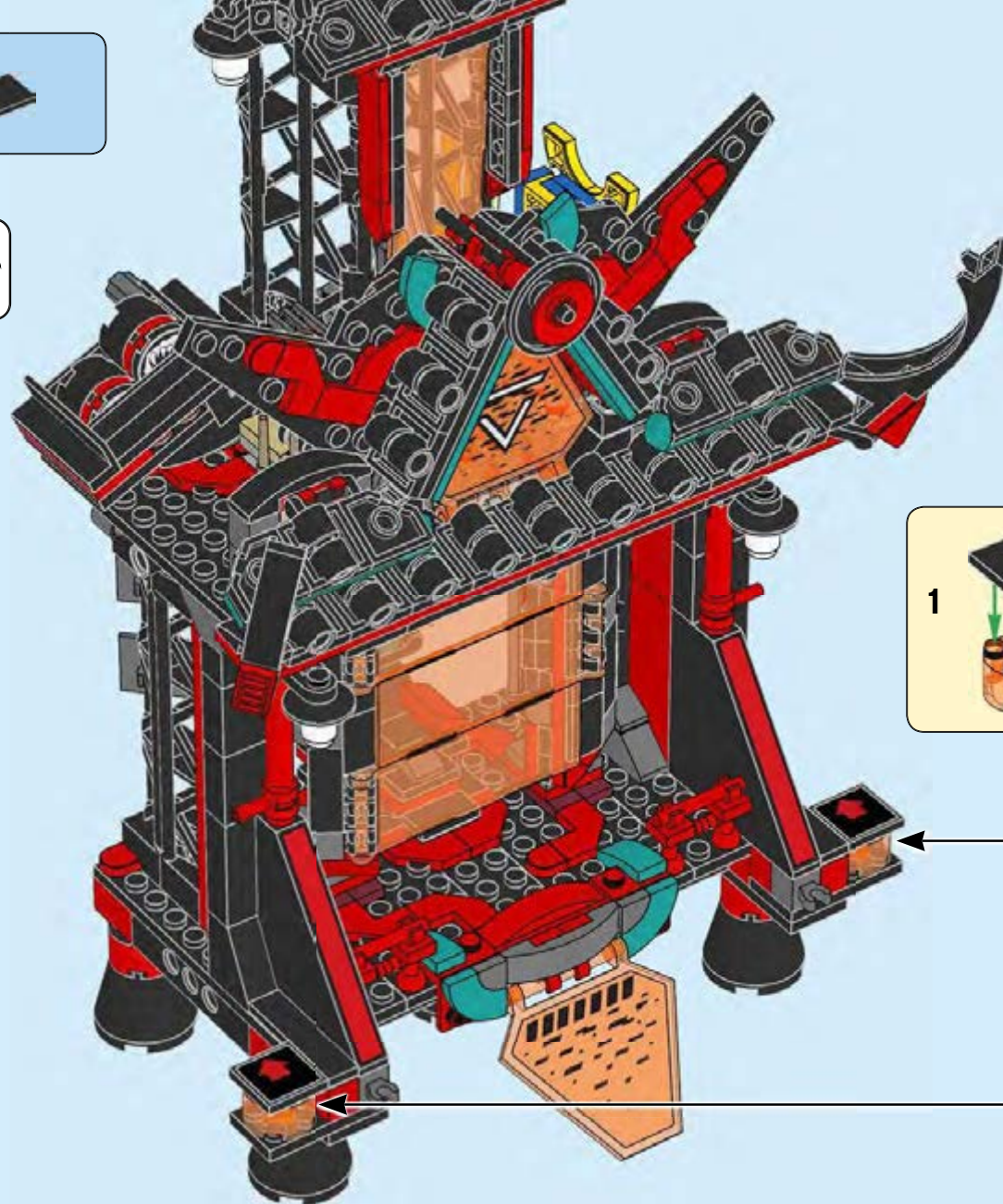





196

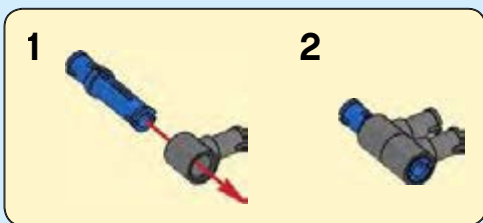
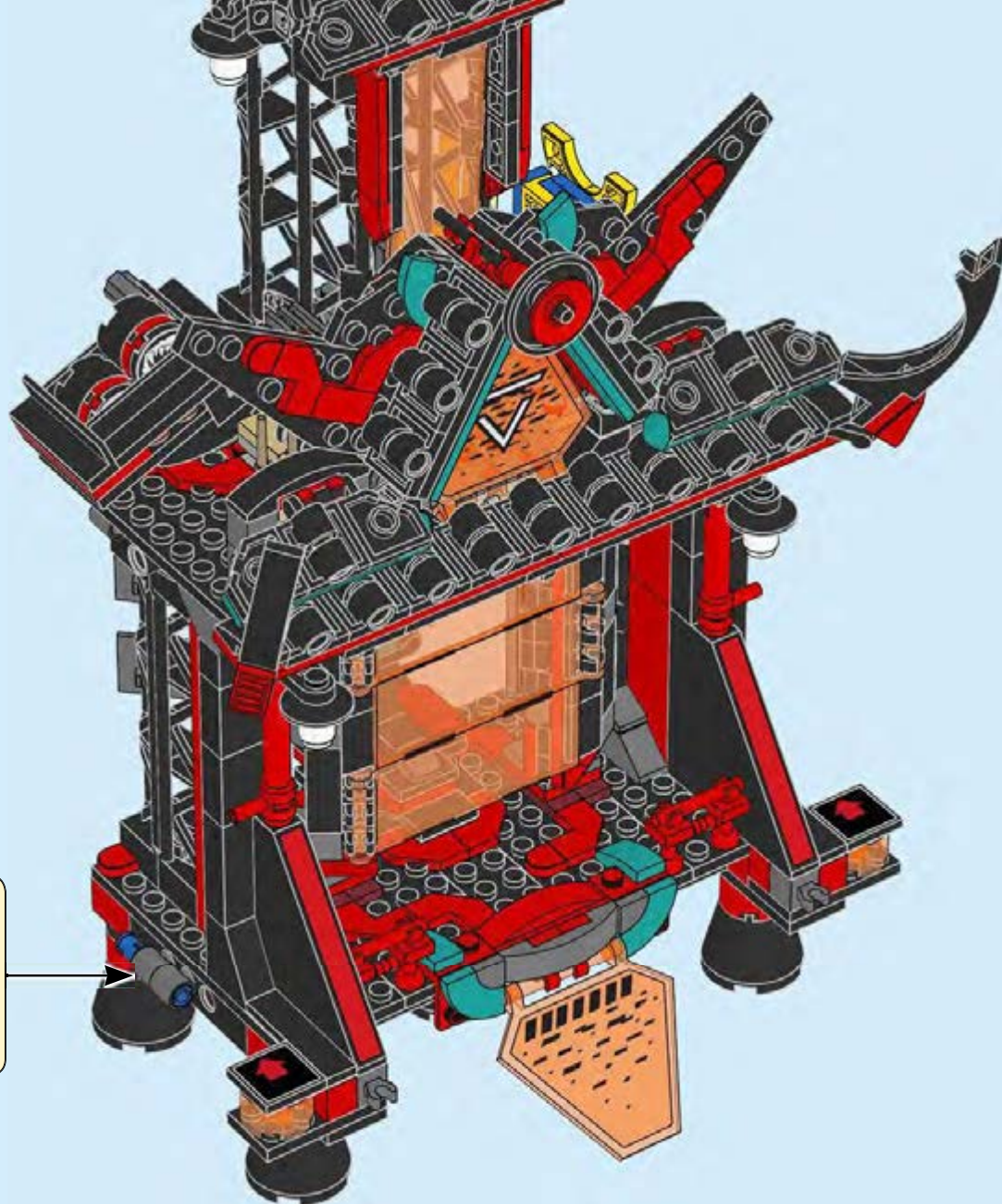

134



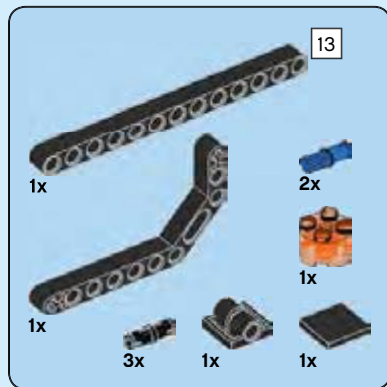

197



1



2



3



4

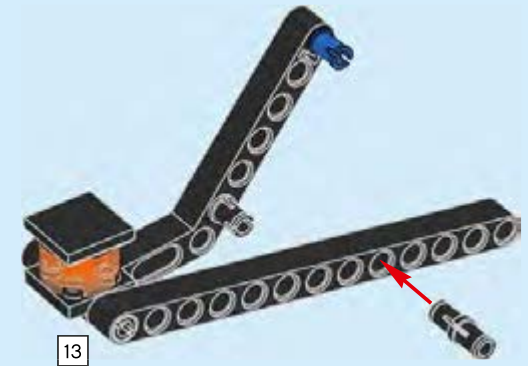

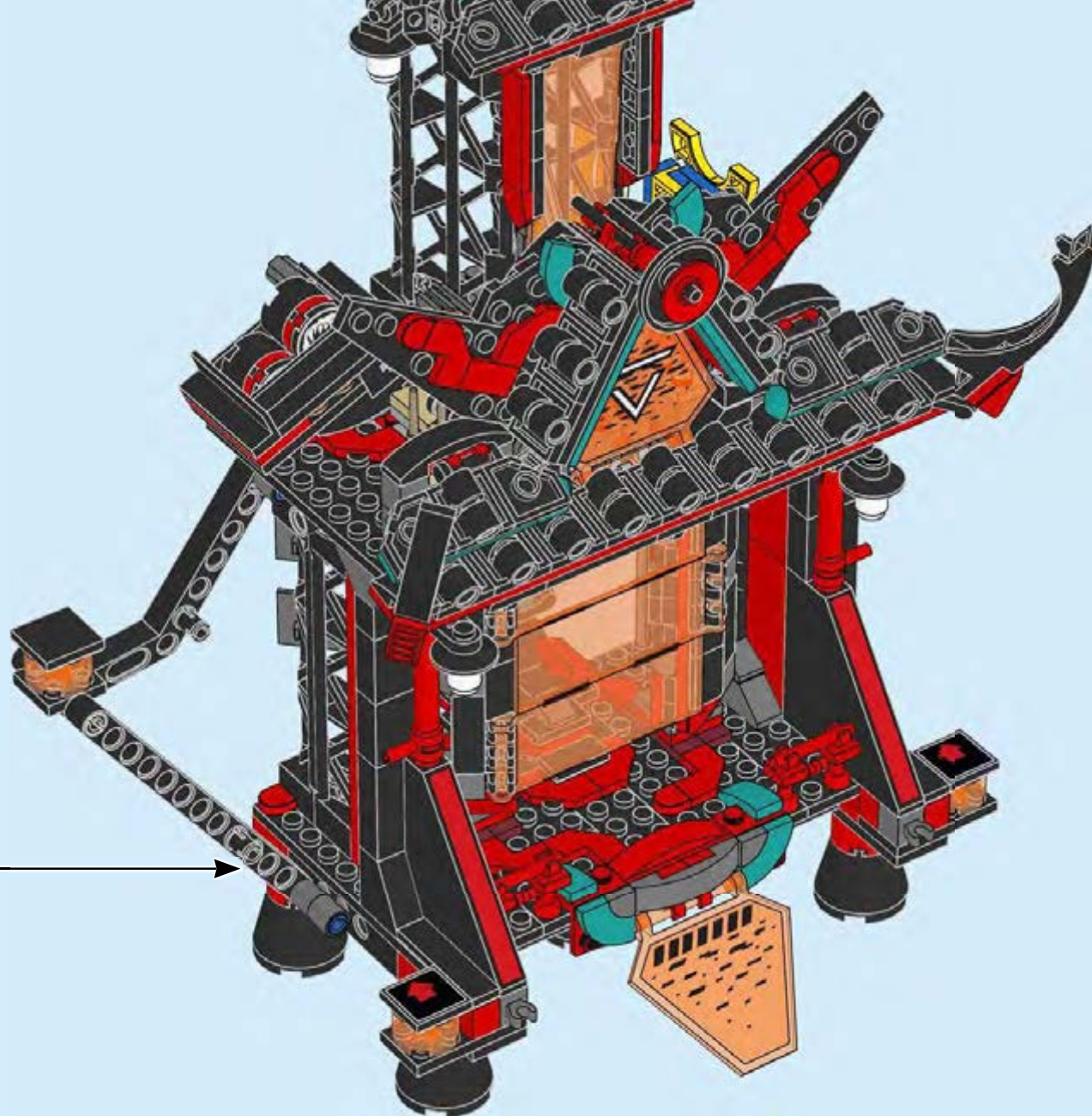



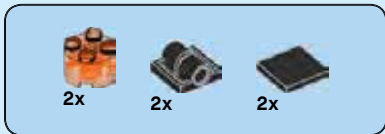

198

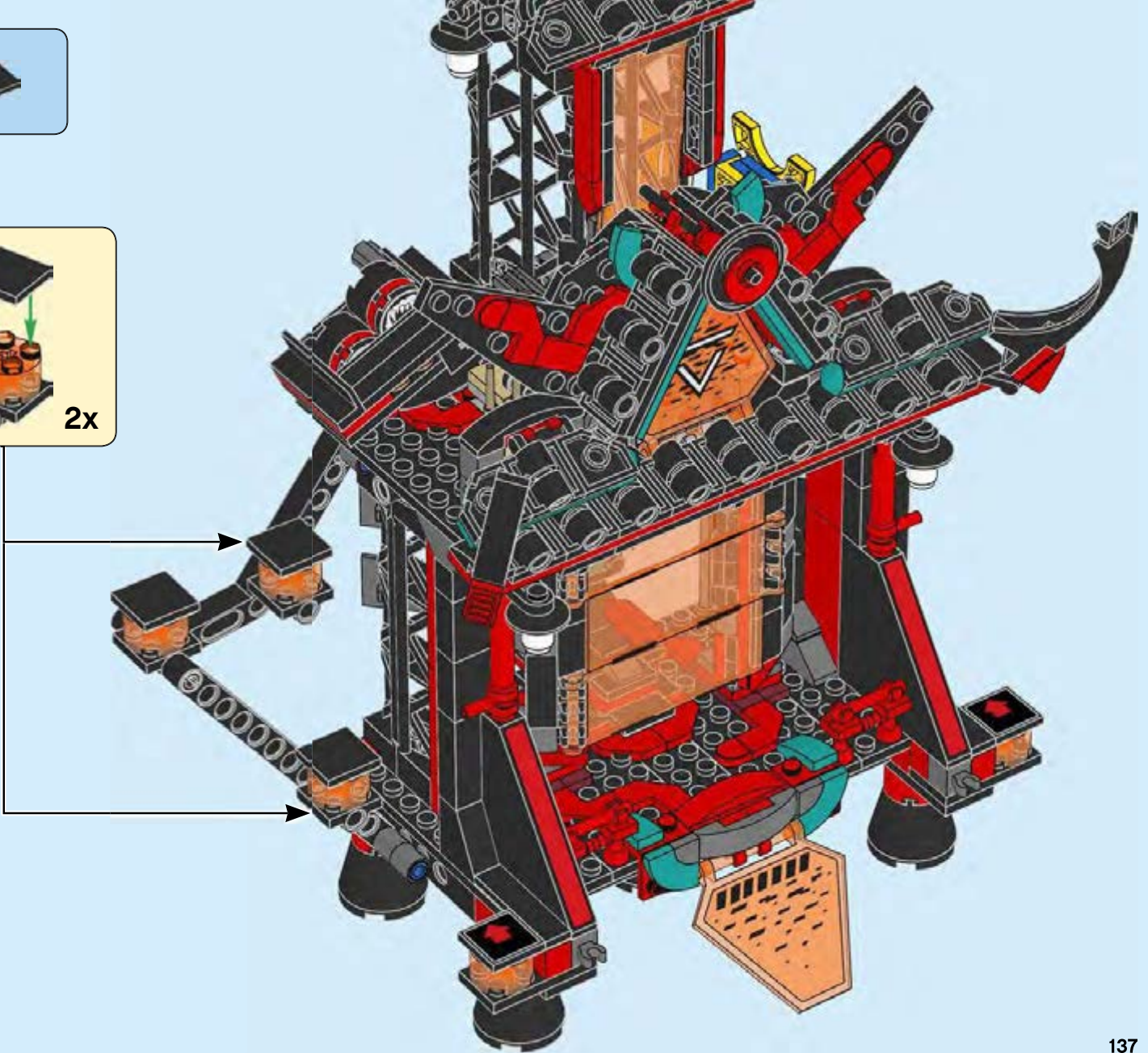
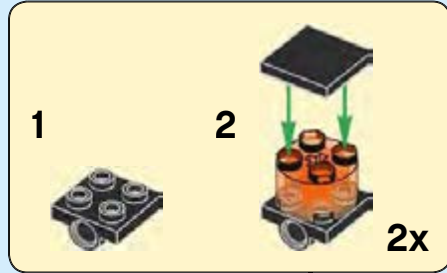

199

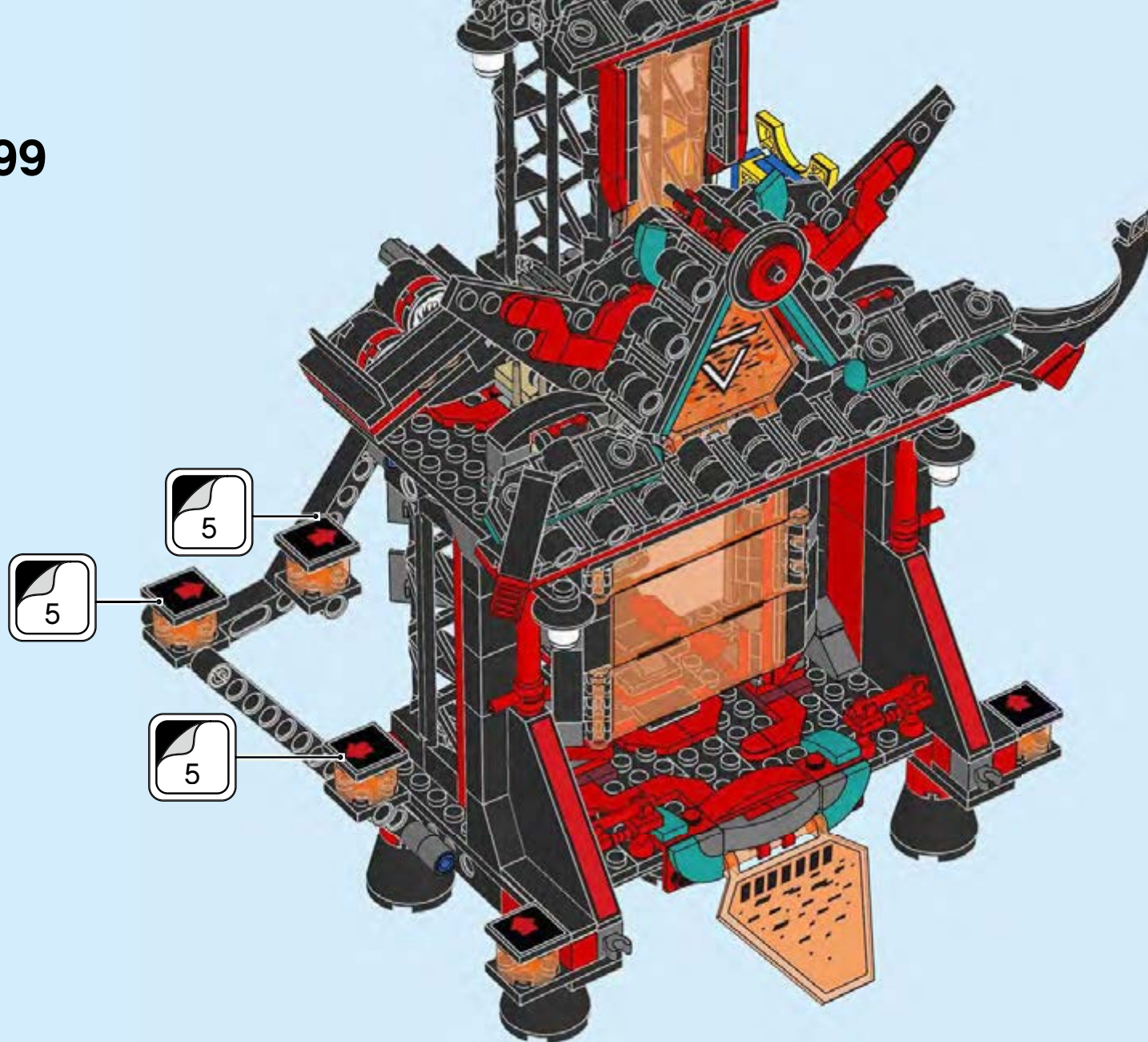

138





200

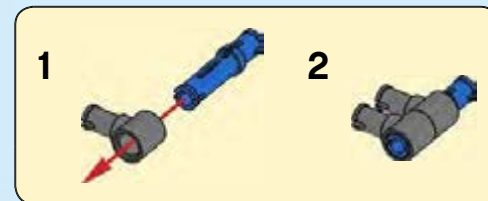
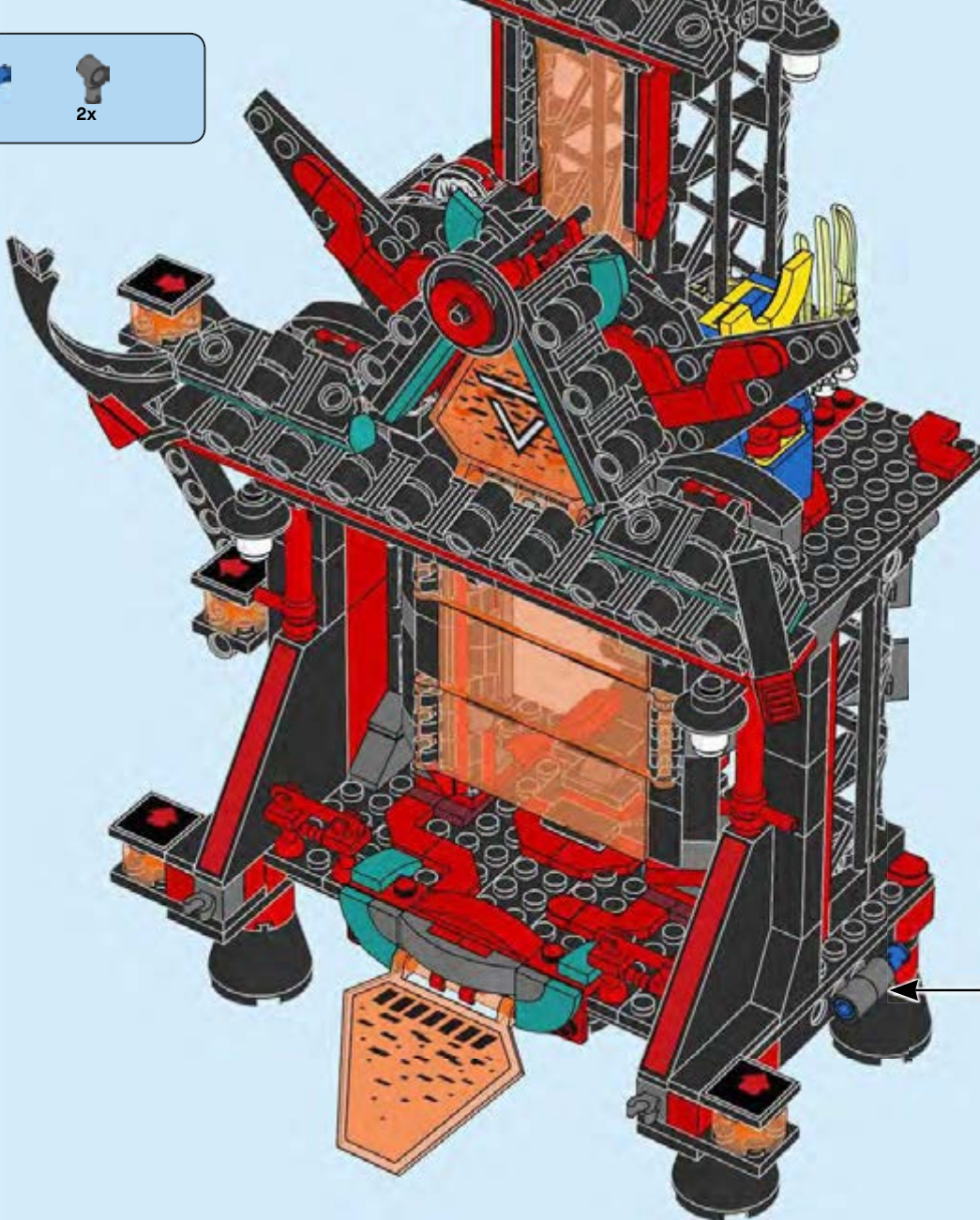

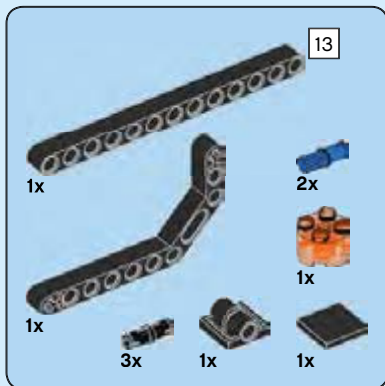

201

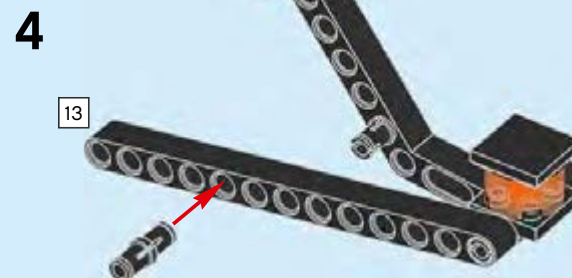

140

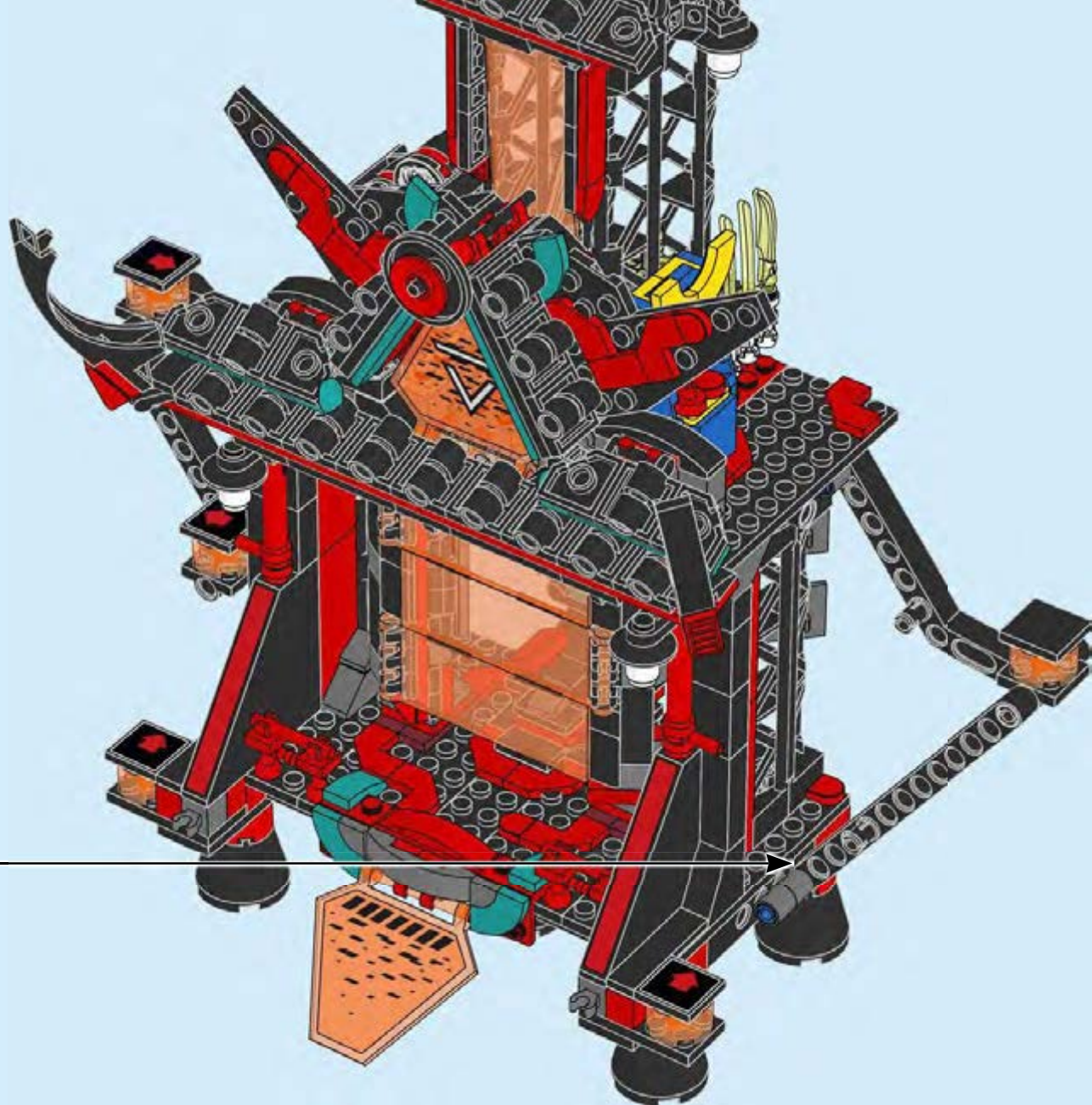





202

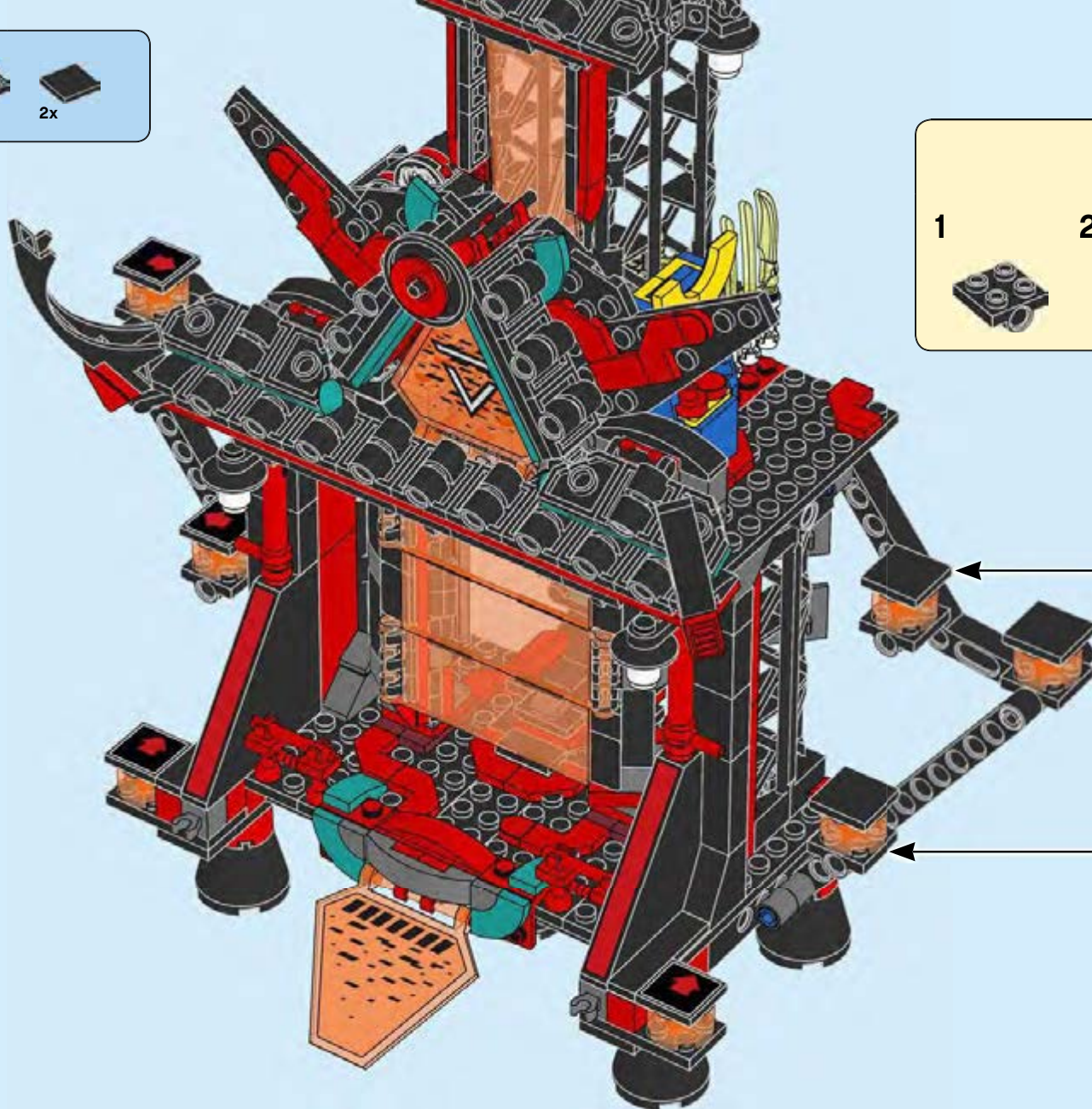

142



203

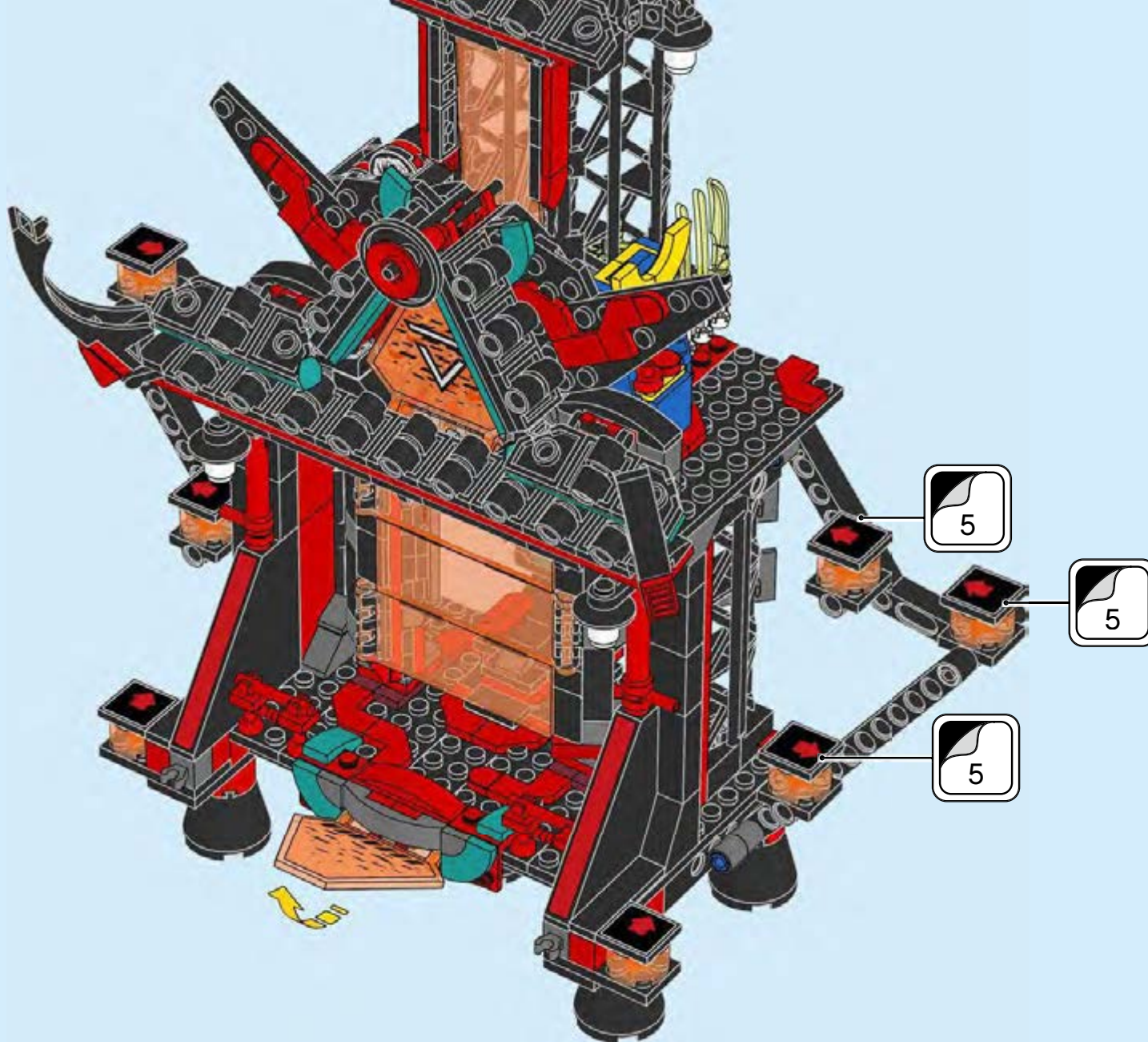



204

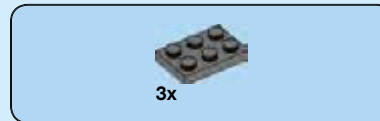

205



206





207

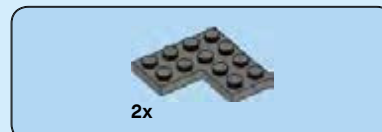

208

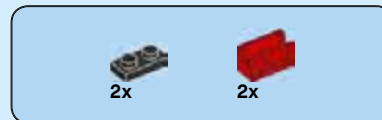

209

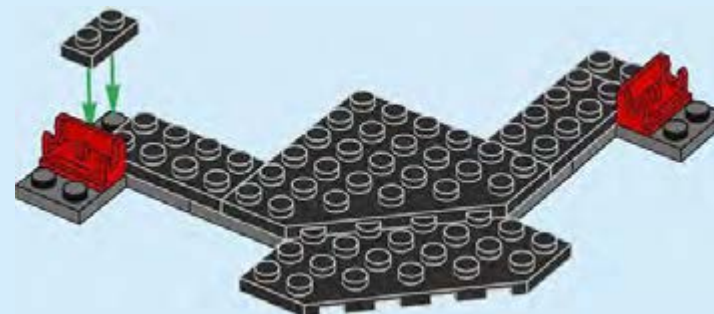

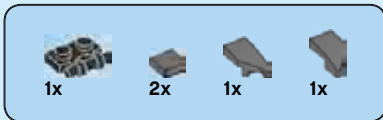

210



211



212

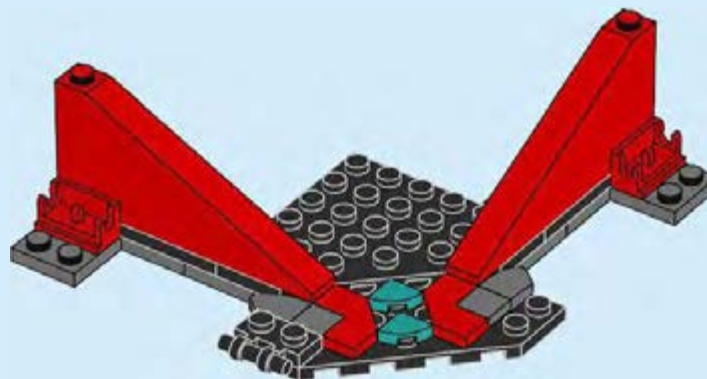



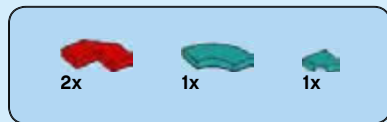

213

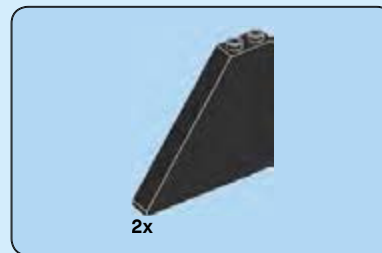
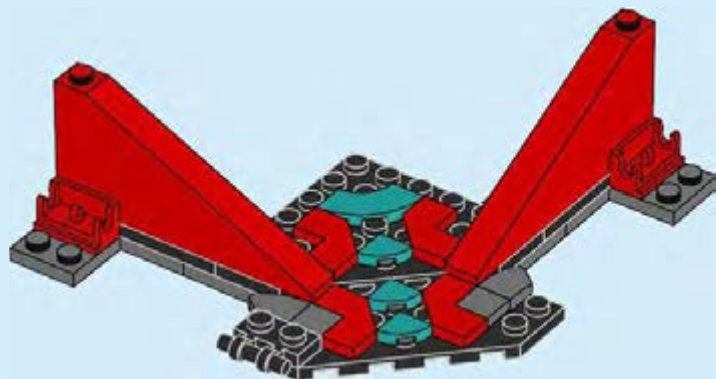

214

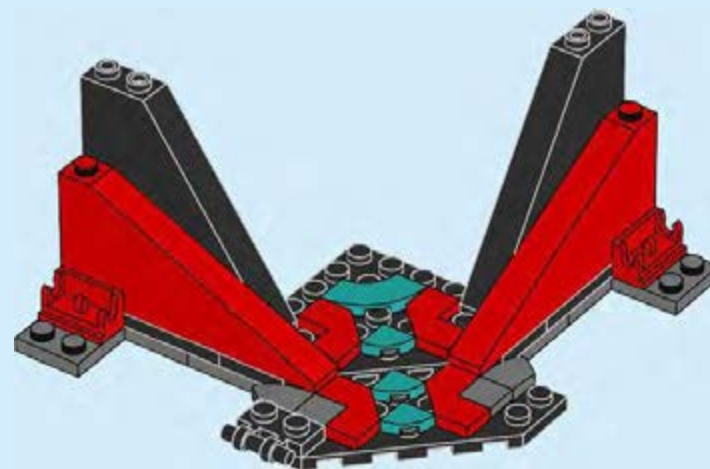



2x



2x

# 215

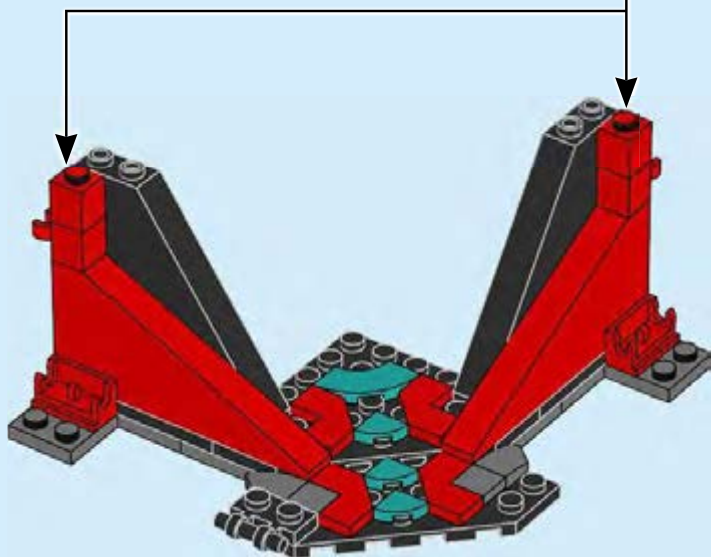
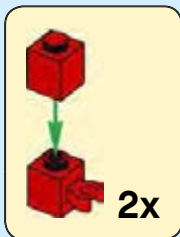

2x



2x

# 216

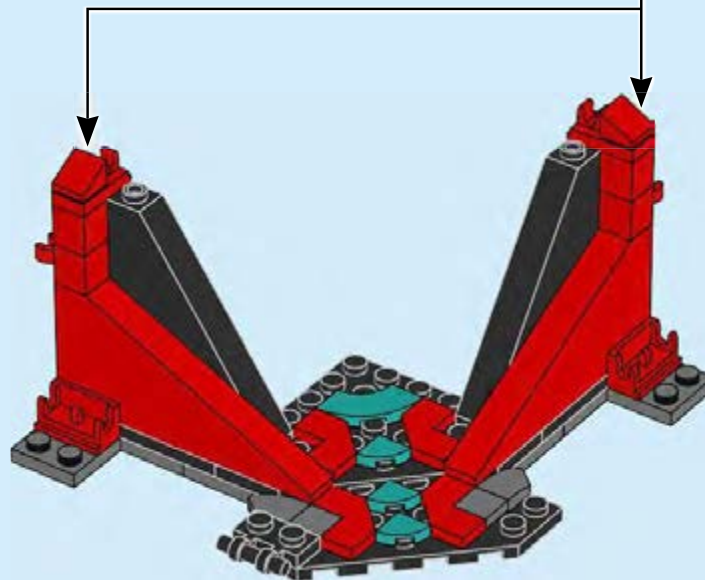
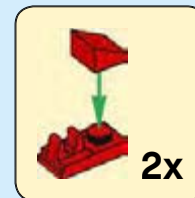

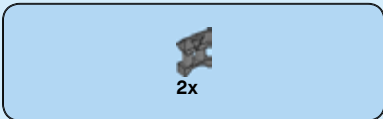

217

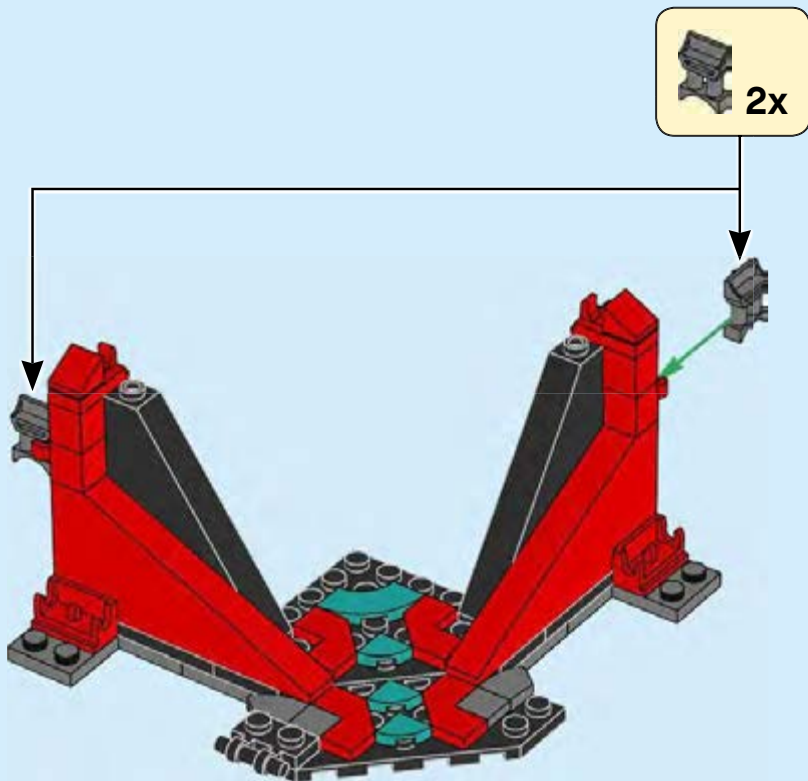

218

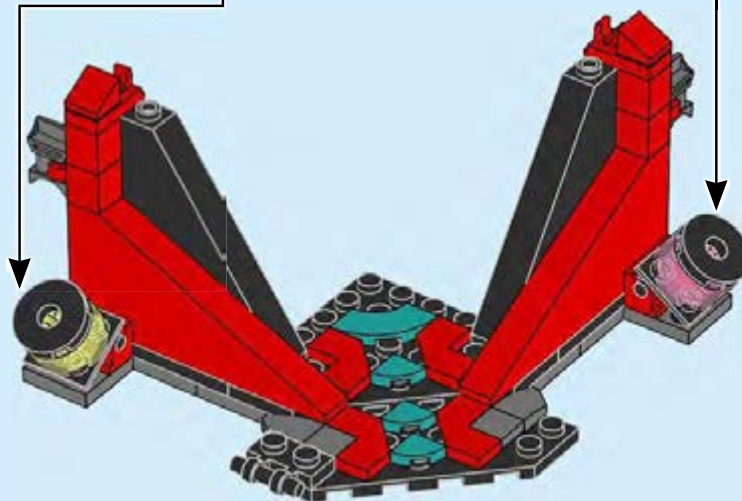

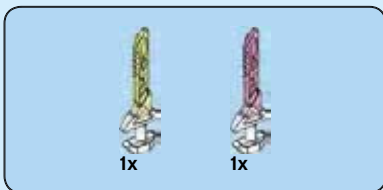

219

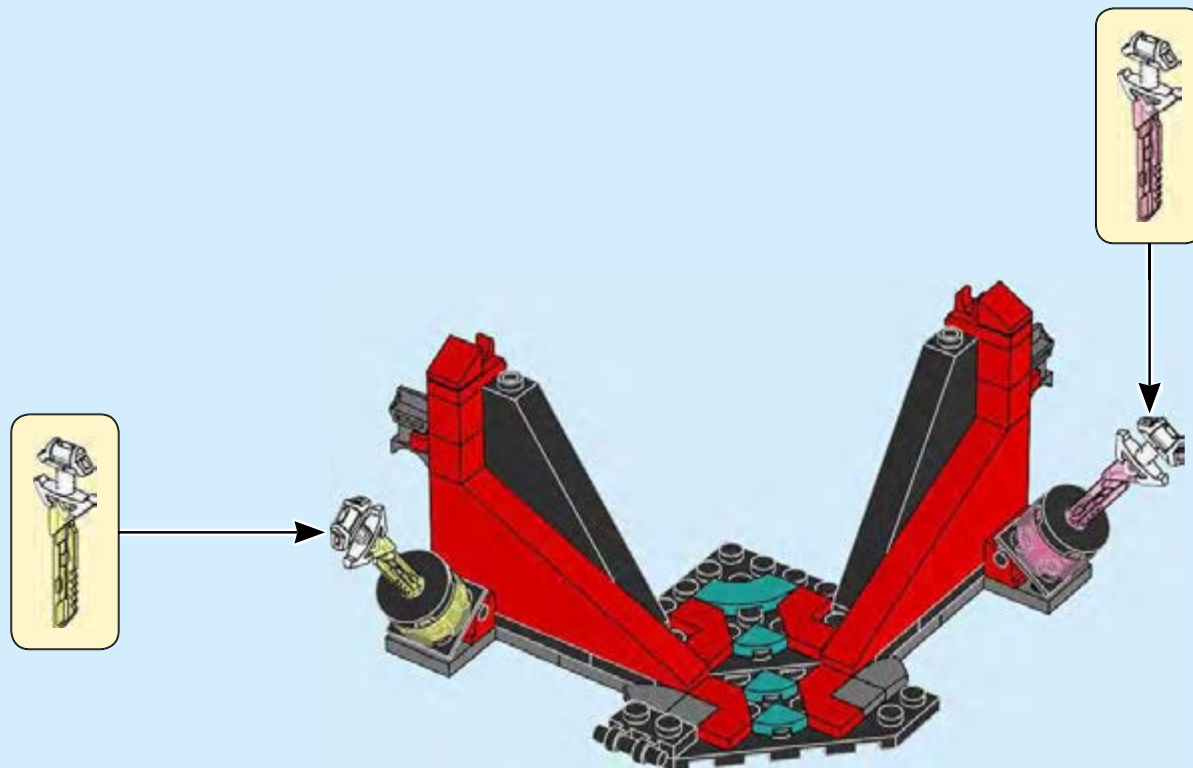

150





220

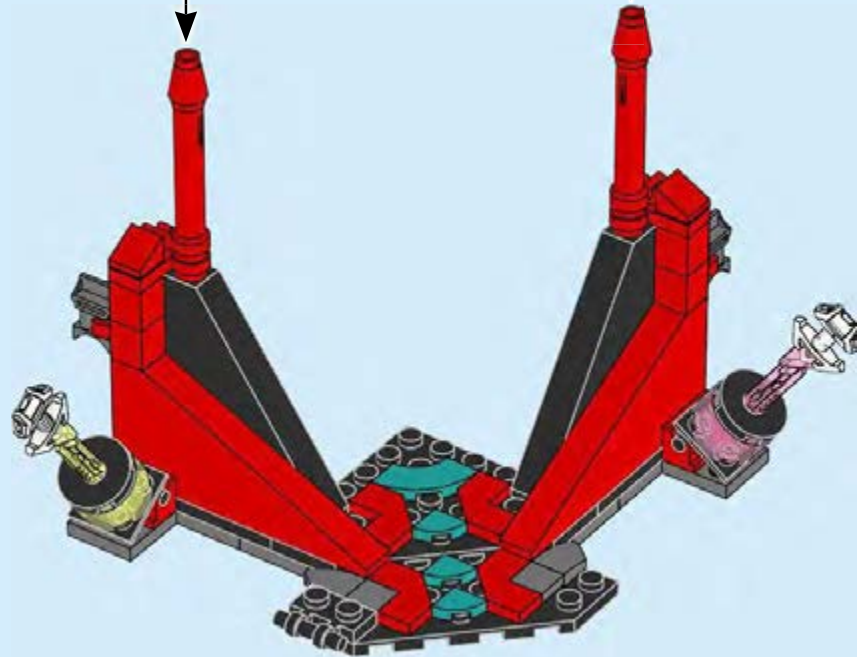



221

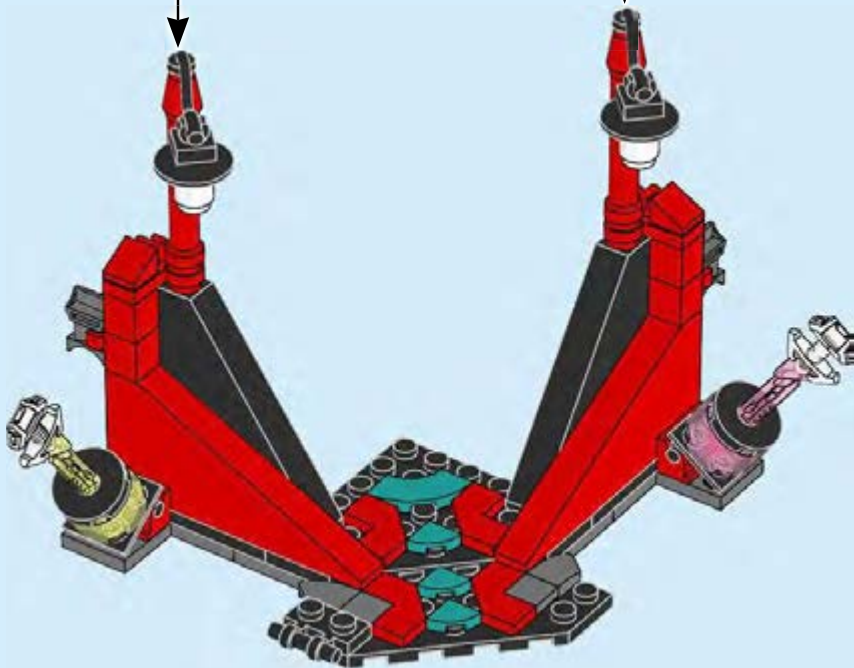

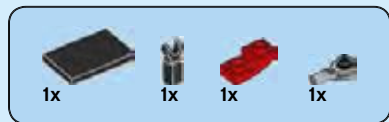

222

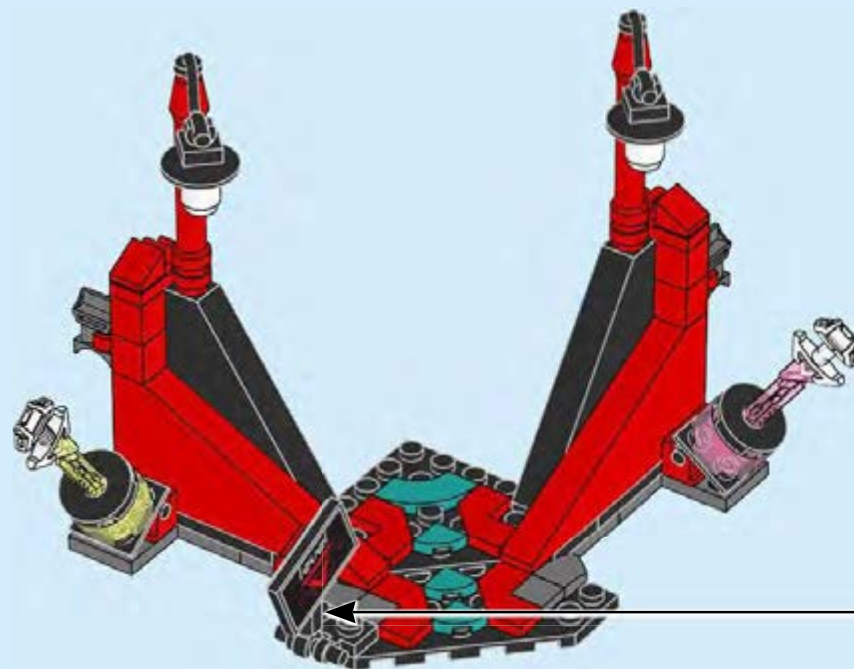

223

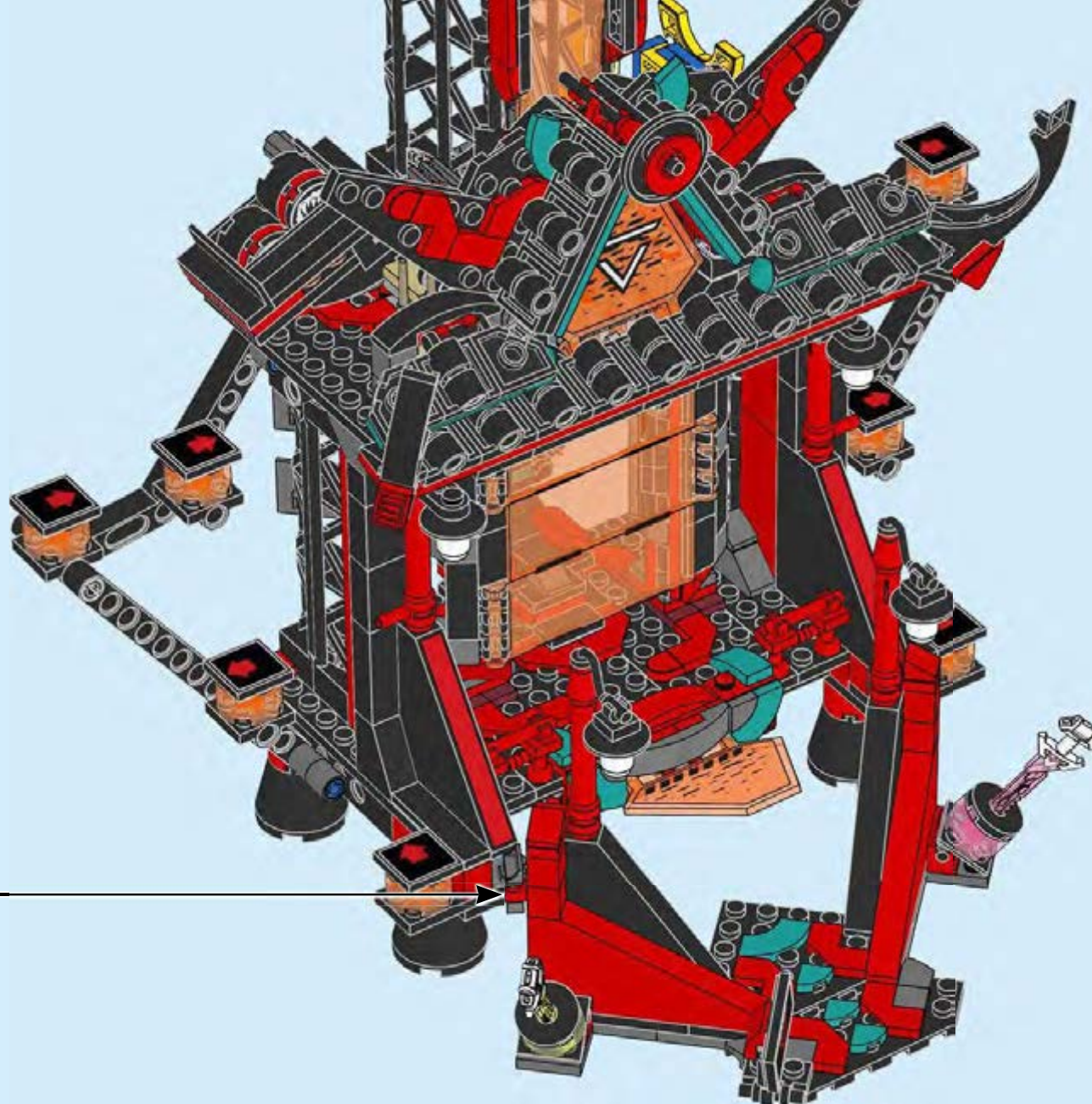

154







ManagerExcellentCrocodile



KingYummyCheetah



PrincessBassyRooster



LEGO.com/apps

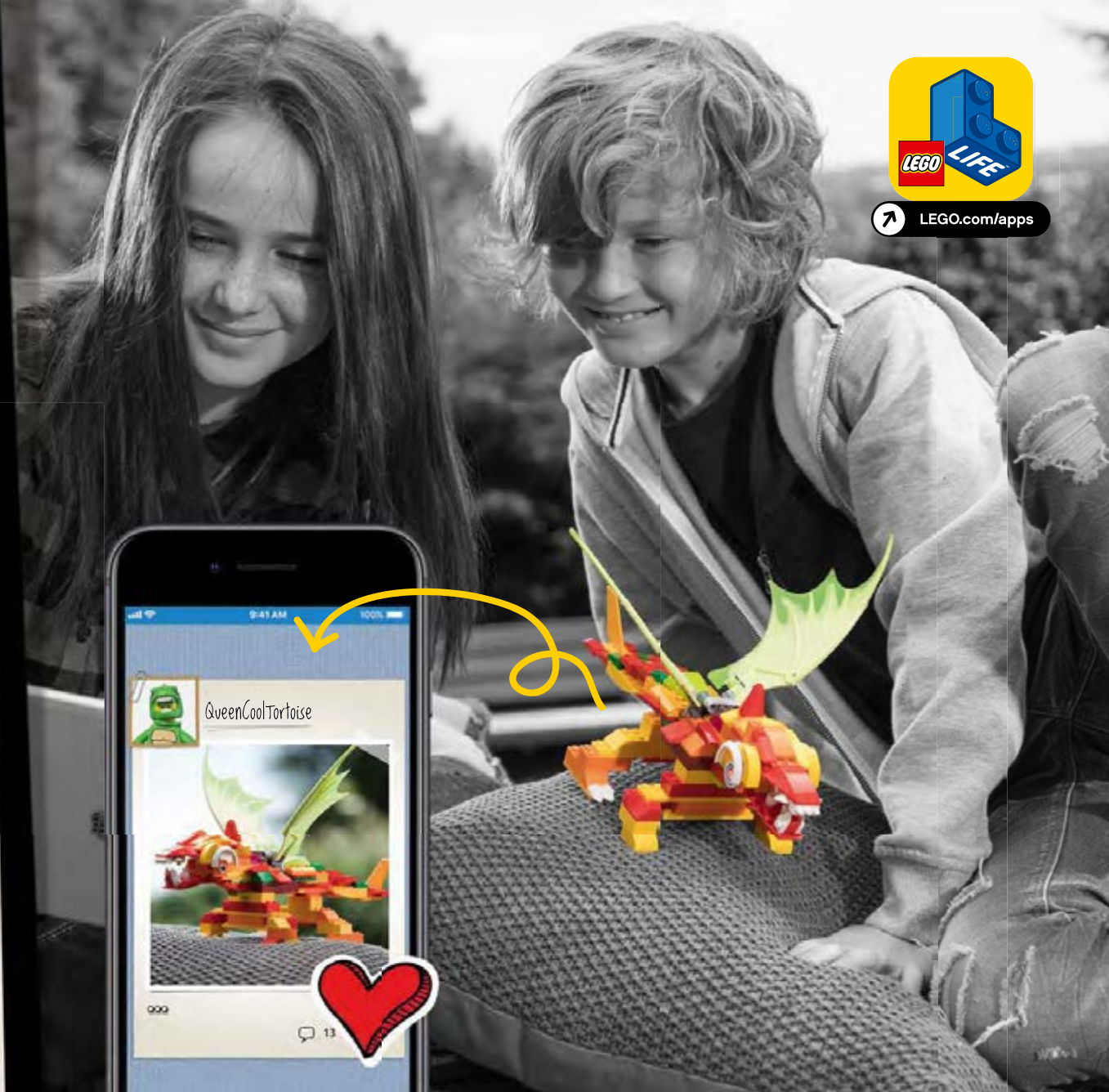

QueenCoolTortoise



13



**LEGO**

# NINJAGO





3x 6040333	2x 4565452	1x 6210269	1x 6178488	21x 6217194	5x 6208752	11x 4206482	1x 6170421	4x 6192778	6x 6174243	1x 6288078	8x 4667463
6x 306201	2x 6029889	4x 4524644	4x 4597713	6x 6209519	1x 6286879	1x 6286879	1x 6015891	6x 6157554	4x 4515373	4x 4225201	8x 4667463
3x 6285528	2x 6221467	1x 6195914	2x 393721	1x 4533742	2x 6262464	2x 302323	1x 6284070	2x 6146095	4x 4618852	1x 6093525	5x 4500978
1x 6287588	1x 4114077	4x 6195914	3x 4540382	1x 6288055	2x 4243814	3x 306823	2x 6168646	4x 4548180	4x 6178922	4x 4248204	5x 4500978
1x 6287570	4x 6208727	1x 6177507	1x 6275178	1x 6284046	2x 4243814	8x 4514553	2x 614126	2x 6051508	2x 6178922	4x 4248204	2x 428626
1x 6287570	1x 6284574	2x 6115324	1x 6275178	1x 6284046	2x 379521	1x 379523	1x 6287939	5x 4143372	16x 6192309	1x 4251393	2x 428626
1x 6287577	3x 4529234	5x 4651524	6x 302321	4x 623221	1x 303421	1x 6271167	1x 6288041	2x 6143850	1x 306926	1x 4251393	2x 428726
1x 6287577	4x 614121	1x 4142865	4x 623221	1x 6168619	1x 303421	1x 6286509	3x 4504382	3x 403226	10x 302326	4x 4558170	4x 4558170
1x 6287580	3x 6215539	2x 403221	4x 4212414	2x 6118830	2x 447721	1x 6287801	4x 6066102	6x 474026	9x 4598528	1x 4251394	1x 6287945
1x 6287580	5x 6258973	1x 6075074	2x 6117974	2x 6118830	4x 383221	1x 6287801	4x 6066102	3x 6288307	2x 4541191	1x 4251394	1x 6099483
1x 6284040	1x 6284040	2x 4157124	3x 4556153	1x 6286215	4x 383221	1x 6287803	2x 6065496	3x 614326	1x 6092585	30x 281726	1x 6162892
1x 6284053	5x 4234429	2x 4585146	5x 4534648	1x 6023770	1x 6023770	1x 6287818	2x 300526	16x 4121715	2x 4121966	2x 6192346	1x 6162892
1x 6288001	8x 459921	1x 4632572	2x 6275080	1x 6287606	1x 6287606	2x 6185994	2x 300526	1x 4121715	2x 6147050	9x 306826	5x 370526
1x 6093526	4x 6072998	5x 614321	1x 6291019	4x 243121	4x 243121	7x 6057458	1x 6257280	1x 6105955	2x 6132731	2x 4613759	2x 243126
4x 6287545	2x 4504379	5x 6053011	4x 302221	1x 4633914	1x 4633914	1x 6224666	4x 6276867	1x 6287279	2x 6055630	5x 4613759	2x 4613153
1x 6296852	1x 6177505	4x 306921	2x 235721	2x 4560179	2x 4560179	2x 6275508	1x 6287609	1x 6287950	1x 6250020	2x 4124096	2x 4613153
158	2x 300521	5x 6186398	2x 242021	1x 302021	1x 4161330	2x 6130008	2x 4517925	2x 6092876	1x 4140588	1x 4180087	6x 6092570

4

5



2x 4227684  
4x 370926  
2x 302026  
1x 370626  
2x 389426  
4x 6291022  
1x 4517986  
1x 6058118  
1x 3200126  
2x 6289822  
2x 303226

3x 4144025  
2x 6271152  
2x 4106977  
2x 273026  
1x 383226  
2x 4188143  
6x 303026  
2x 4522933  
5x 4107558

1x 6287520  
1x 6286619  
1x 6286827  
3x 6240467  
2x 6213782  
2x 6210445  
4x 6213779  
2x 6213777  
4x 6249427  
5x 6213876  
4x 6292786  
2x 6264986  
6x 6288255  
3x 6287600  
3x 6170186  
1x 6273157  
1x 6290368

1x 6290400  
6x 6240218  
2x 6301326  
1x 6287936  
2x 6245295  
2x 6287583  
5x 6288243  
2x 6287611  
8x 6273156  
2x 6291015  
5x 6286890  
1x 6288402

2x 6153590  
1x 6088641  
1x 6270031  
3x 6296894  
2x 4542590  
1x 6275844  
1x 6254404  
2x 4211483  
1x 4255629  
4x 4211476  
1x 4211508  
1x 6227897  
1x 6173127  
1x 4211398  
1x 6240515

6x 4598526  
2x 4525904  
1x 4211613  
1x 4211815  
1x 4211639  
2x 4211805  
2x 4289542  
2x 4211224  
2x 6100030  
6x 6175330  
3x 4211098  
4x 4504378  
2x 4210848  
1x 6204668  
2x 6199549

1x 4210639  
4x 6063616  
1x 6204667  
4x 4580437  
1x 4623236  
1x 6055313  
2x 6135014  
2x 6006141  
2x 4516546  
2x 4211088  
3x 4210631  
6x 6168776  
4x 6178919  
2x 4211135  
2x 4210763

2x 6100124  
2x 4211094  
2x 4211129  
2x 4211109  
1x 4520307  
4x 4521187  
3x 4211104  
7x 4211133  
1x 6287022  
1x 4211046  
3x 4211043

1x 6122727  
3x 4211024  
1x 6083620  
1x 4648256  
1x 4528323  
2x 4560184  
3x 4211085  
4x 4620760  
2x 4539429  
1x 421134

6

13

3

5

7

4



Customer Service  
Kundenservice  
Service Consommateurs  
Servicio Al Consumidor

LEGO.com/service or dial

: 00800 5346 5555  
: 1-800-422-5346

A LEGO Ninjabo character in a black and green suit, holding a sword, is positioned on the right side of the advertisement. The background is a bright yellow gradient.

# WIN

GO TO [WWW.LEGO.COM/PRODUCTFEEDBACK](http://WWW.LEGO.COM/PRODUCTFEEDBACK) AND  
GIVE US YOUR SHORT **FEEDBACK** ABOUT THIS  
LEGO® SET FOR A CHANCE TO WIN  
A COOL LEGO PRIZE.

Terms & Conditions apply

## LEGO.com/productfeedback

### GEWINNE

Erzähle uns auf  
[www.LEGO.com/productfeedback](http://www.LEGO.com/productfeedback)

etwas über die Erfahrungen, die du  
mit diesem LEGO® Set gemacht hast,  
und sichere dir die Chance auf einen  
coolen LEGO Preis!

Es gelten die Teilnahmebedingungen

### GAGNE

Rends-toi sur  
[www.LEGO.com/productfeedback](http://www.LEGO.com/productfeedback)

et donne-nous quelques commen-  
taires sur ce produit LEGO® pour  
avoir une chance de gagner un  
prix LEGO !

Voir Conditions Générales

### GANAN

Visita  
[www.LEGO.com/productfeedback](http://www.LEGO.com/productfeedback)

y envíanos tu opinión acerca de este  
set LEGO®. ¡Participarás en el sorteo  
de un premio LEGO!

Términos y Condiciones aplicables

### 获取奖品

登录  
[www.LEGO.com/productfeedback](http://www.LEGO.com/productfeedback)

给出关于此乐高®套装的简短反  
馈，就有机会获得炫酷乐高奖品

《条款及条件》适用

LEGO, the LEGO logo, NINJAGO and the NINJAGO logo are trademarks of the/son des marques de commerce du/son marcas registradas de LEGO Group. ©2020 The LEGO Group.

6313572/6313573