



CITY

60262





2

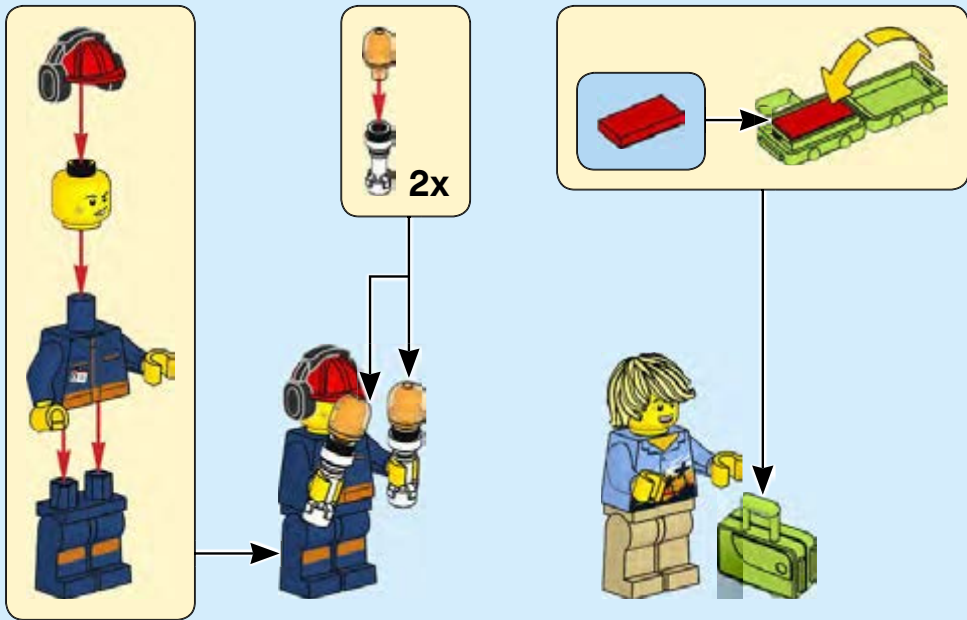

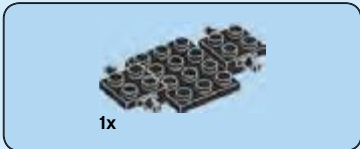

1



4

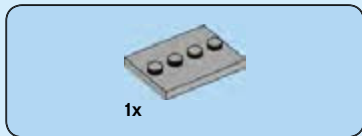

2



3

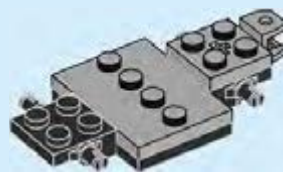

5



4



6



5



6



7



1x

7



8

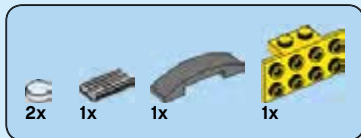

8





1x

9

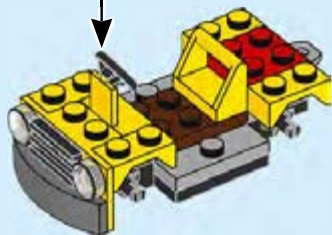

10

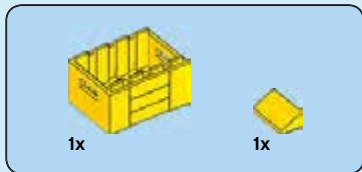

10

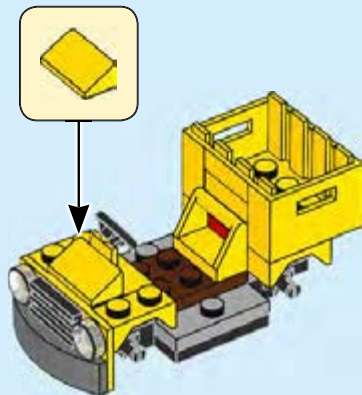



4x



4x

11

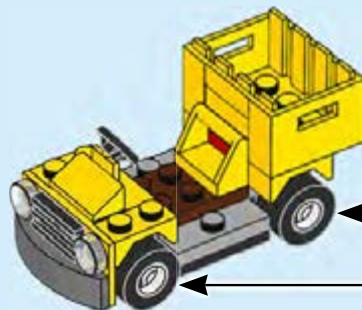

12



12

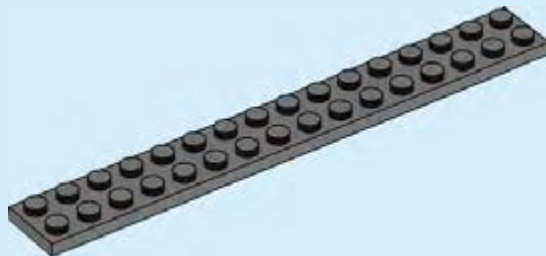



1x



1x

13



14

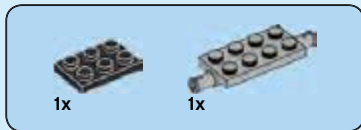

14

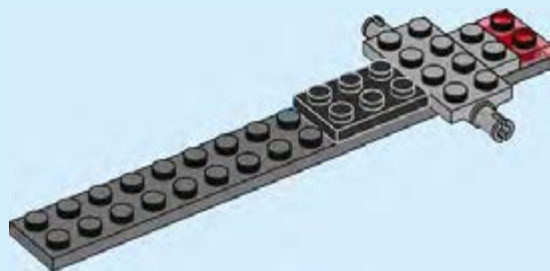

15



15

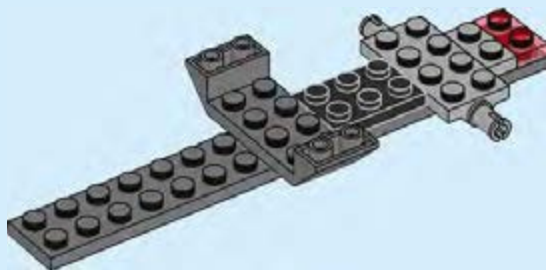

16

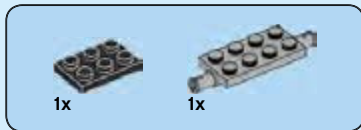

16

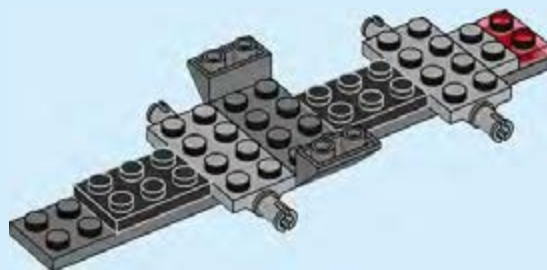

17



1x

17

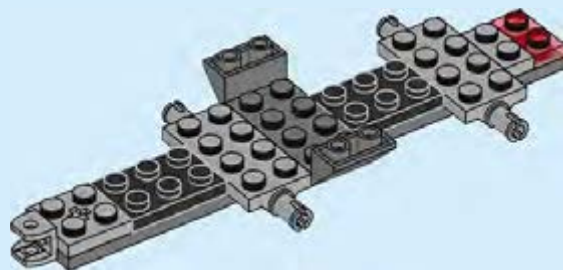

18

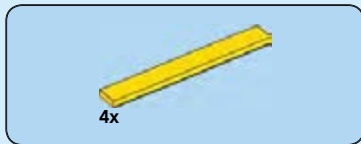

18

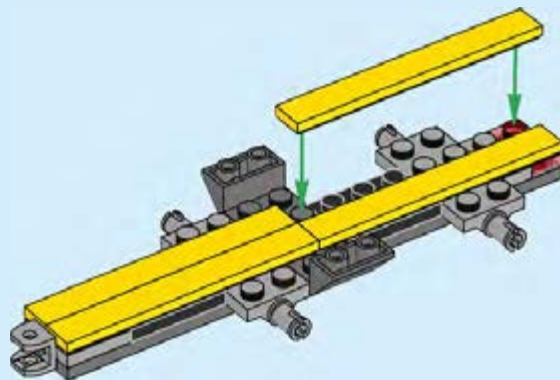

19



19

1



2



3



20

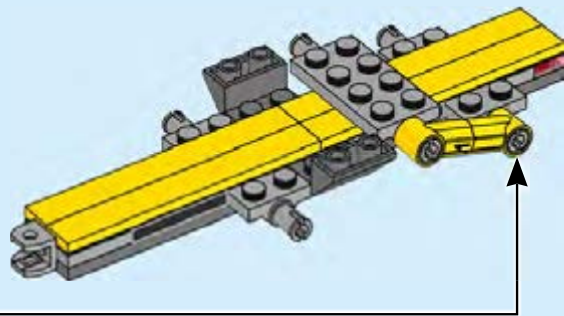



2x



1x

20

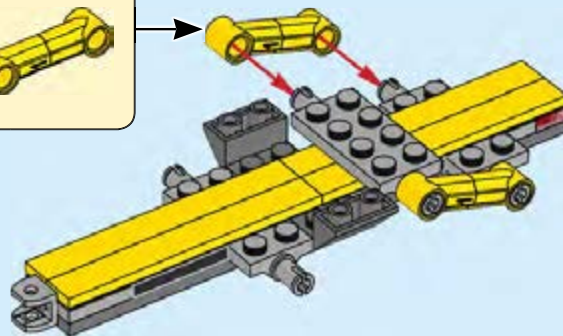
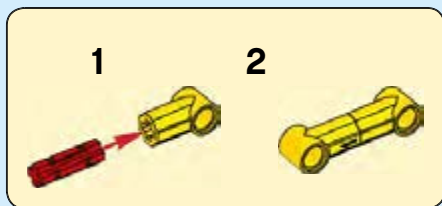

22



21

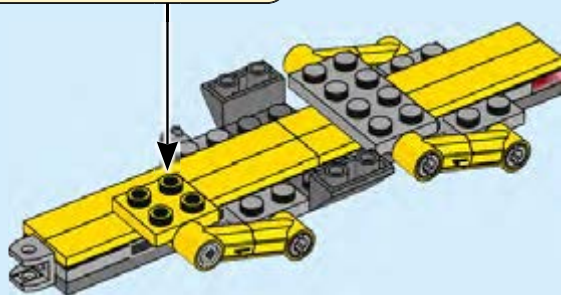
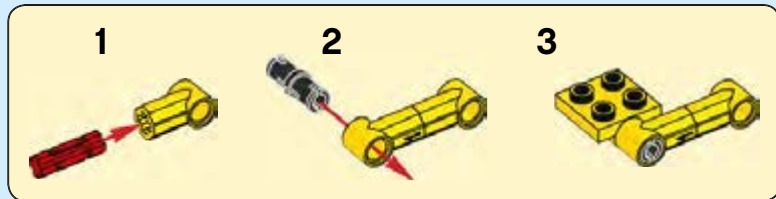

23



22

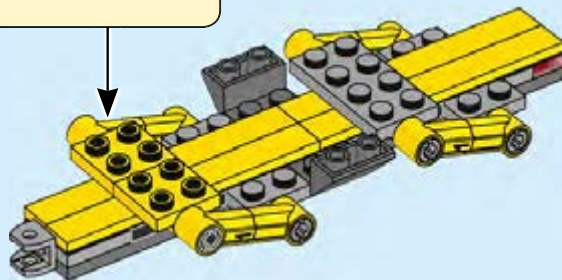
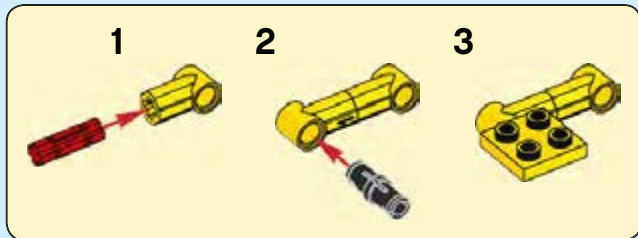

24



23

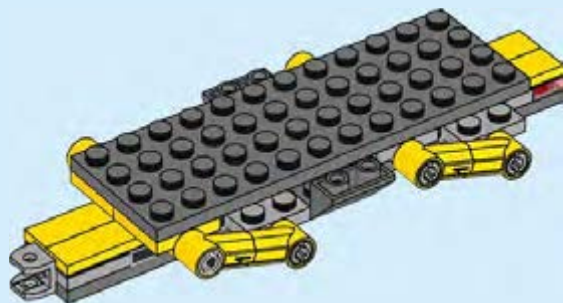

25



24

1



2

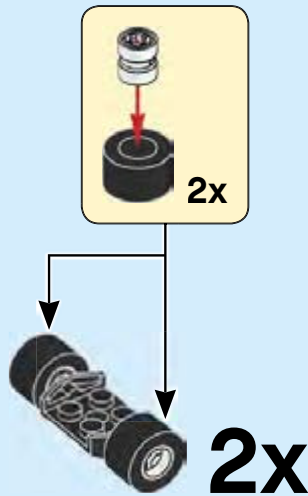

26

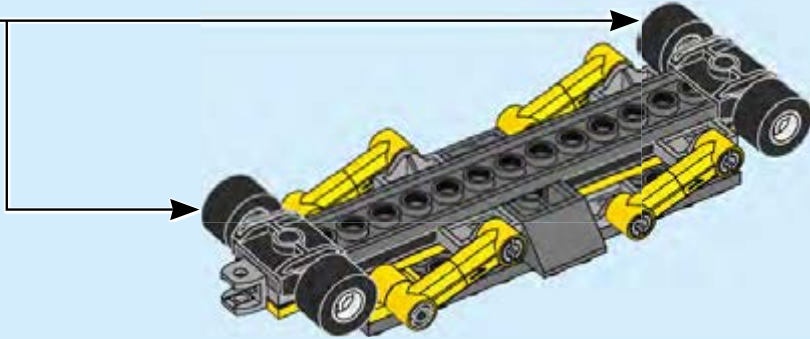



25

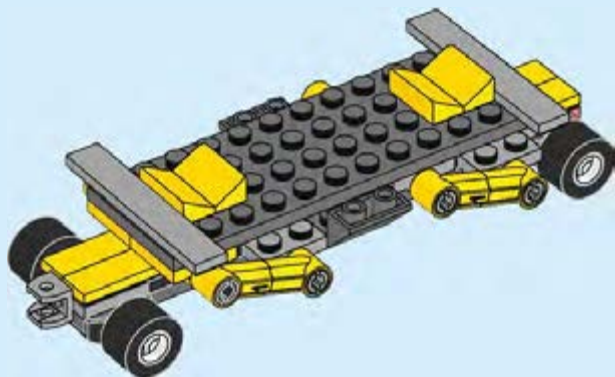

28



2x

26

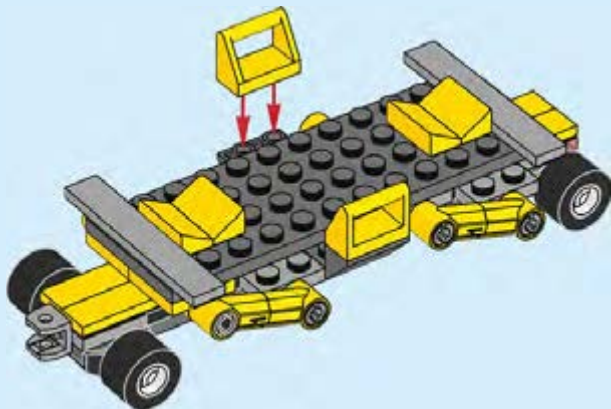

2x

1x

27

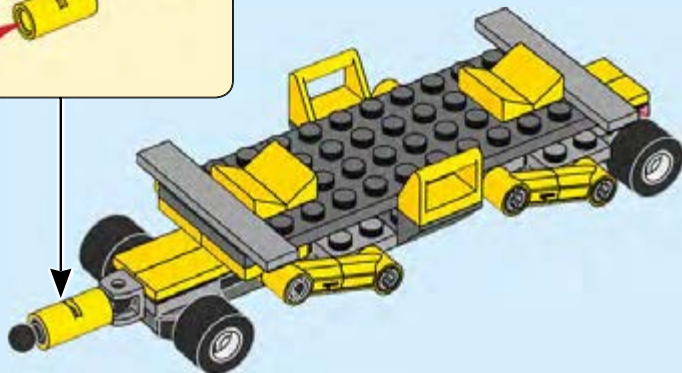
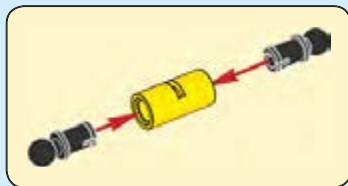

30

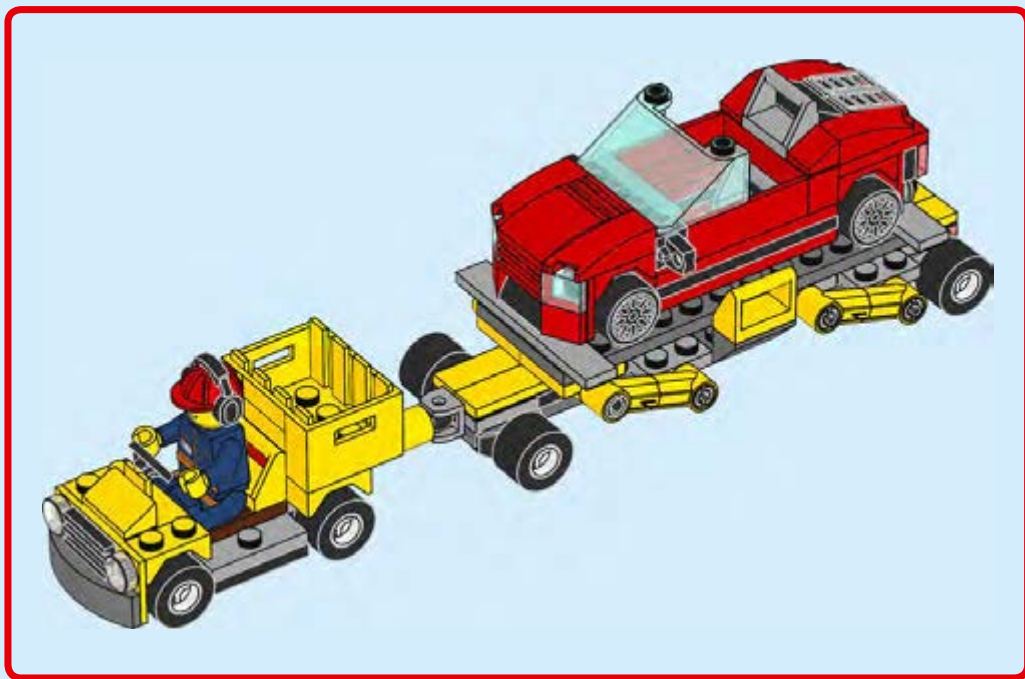



CITY



RIVERA

60260



POPPY STARR

60262



JESSICA SHARPE

60264



HARL HIGGS

60266



DUKE DEYAIN

60242 60246



SAM GRIZZLED

60243



ROOKY BARTNIR

60244



TOM BENNETT

60245



WHEELER

60246



CLEMMONS

60247



FREYA McCLOUD

60248



VITO

60242



SNAKE RATTLER

60243



FRANKIE LUPELLI

60244



BIG BETTY

60245



DAISY KABOOM

60246



TREAD OCTANE

60258



HARL HIGGS

60258

LEGO and the LEGO logo are trademarks of the LEGO Group. ©2020 The LEGO Group. 6324151