



# duplo

Floats  
Schwimmt  
Flotte  
Galleggia  
Flota  
Flutua  
Úszik  
Peld  
可漂浮

Makes air bubbles  
Macht Luftblasen  
Fait des bulles  
Emette bolle d'aria  
Hace burbujas  
Faz bolhas de ar  
Buborékot fúj  
Rada gaisa burbulus  
可产生气泡



# 10907

LEGO.com/DUPLO



# LEGO duplo

Floats  
Schwimmt  
Flotte  
Galleggia  
Flota  
Plutua  
Úszik  
Peld  
可漂浮

FLOATS



10910  
Age 2+



10886  
Age 1½+



Age

# 1½



10847  
Age 1½+



Disney  
**FROZEN**

Light brick  
Leuchtbaustein  
Brique lumineuse  
Mattoncino luminoso  
Ladrillo luminoso  
Peça luminosa  
Világító elem  
Gaismas klucītis  
发光积木



**10899**  
Age 2+



© Disney



**10902**  
Age 2+

Light and Sound  
Licht und Geräusche  
Son et lumière  
Luci e suoni  
Luz y sonidos  
Luz e Som  
Fény és hang  
Gaisma un skaņa  
灯光和声音



**10904**  
Age 2+

**5**



**duplo**

KREATIVITÄT VERBINDET, CRÉER ET CONNECTER,  
CREA E CONNETTI, CRIA E CONECTA,  
ALKOSSATOK EGYÜTT!, IZVEIDO UN SAVIENO,  
创意玩伴 亲子同乐

**CREATE & CONNECT**



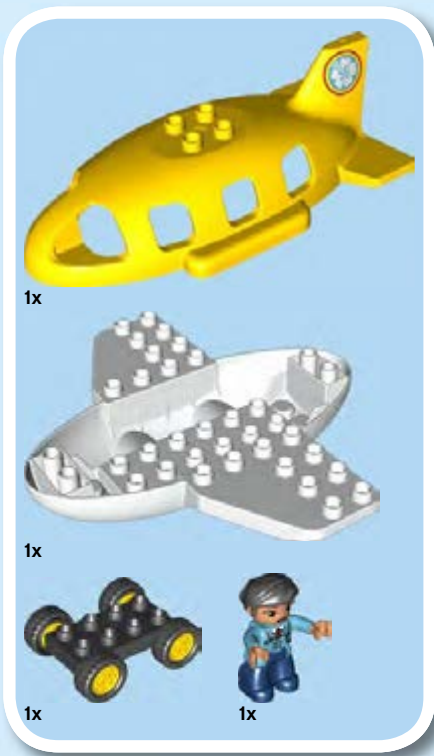

1



5

2



6



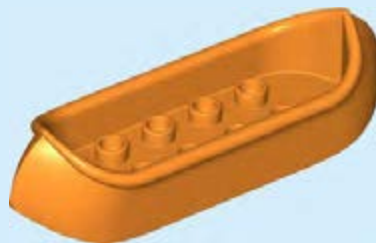



1



8



2

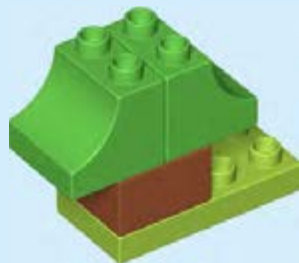



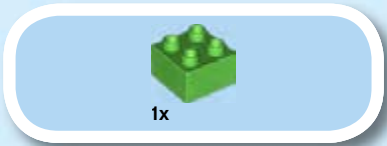

3

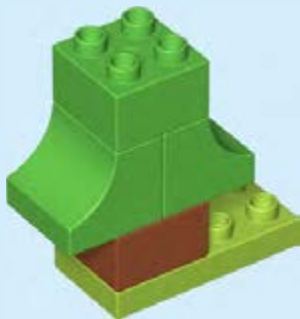

4



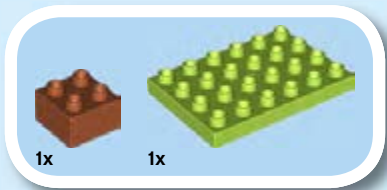

1

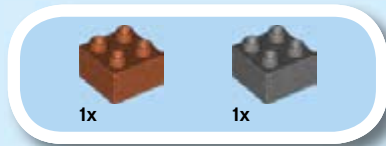
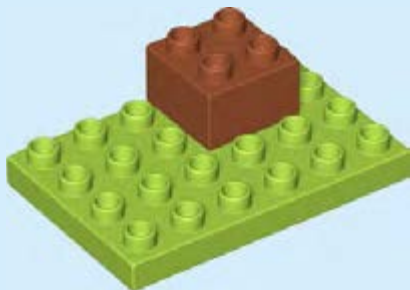

2

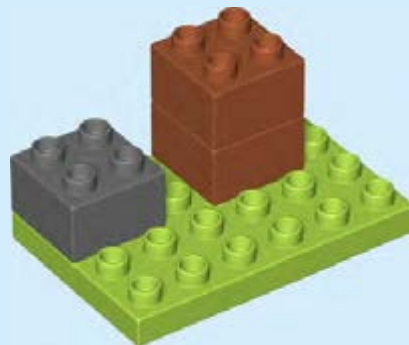



3

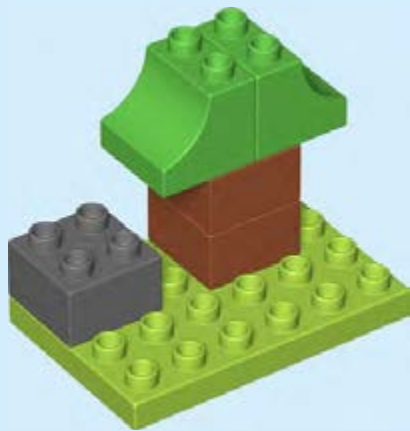

4





5



6



12



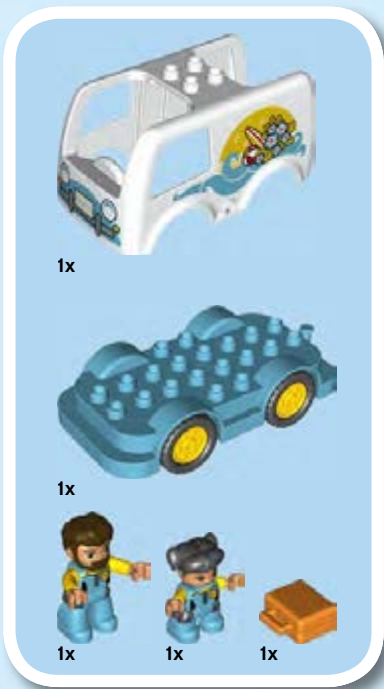



1

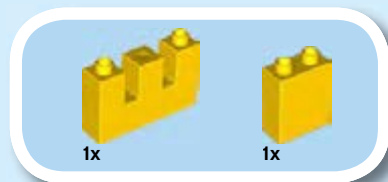

2





3

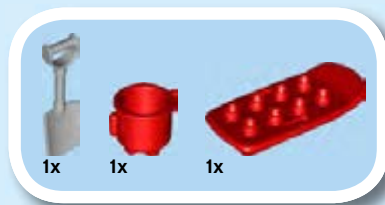
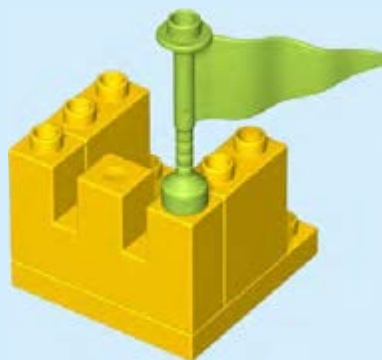

4

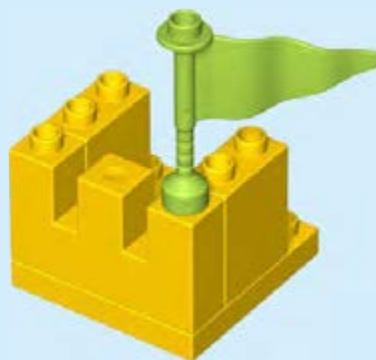

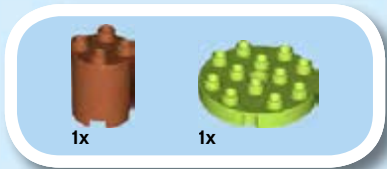

1x

1x

1



16

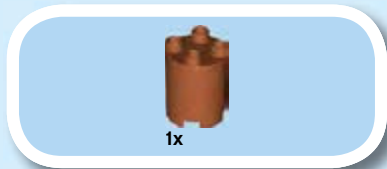

1x

2







3



4



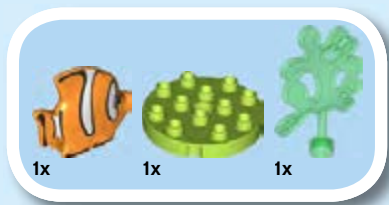

1



2



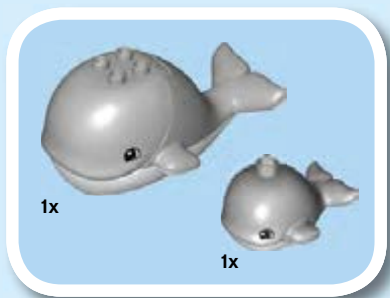

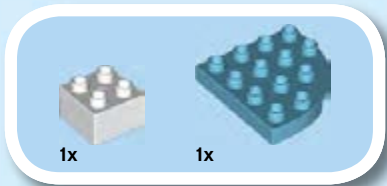

1

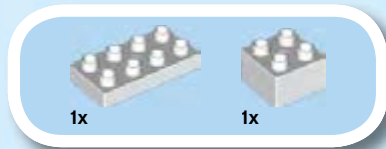

2

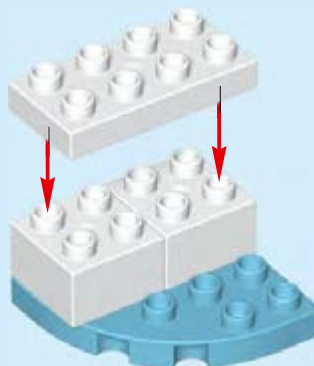





3



4





22

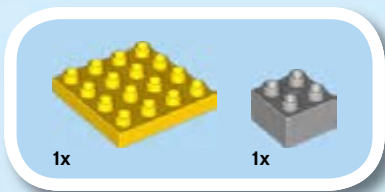

1



2



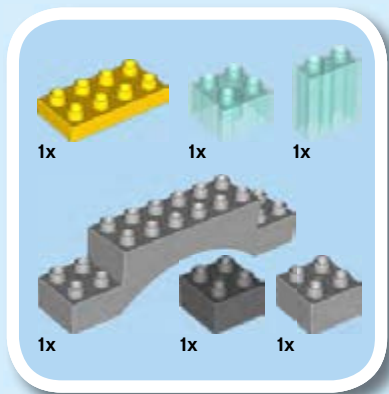

3

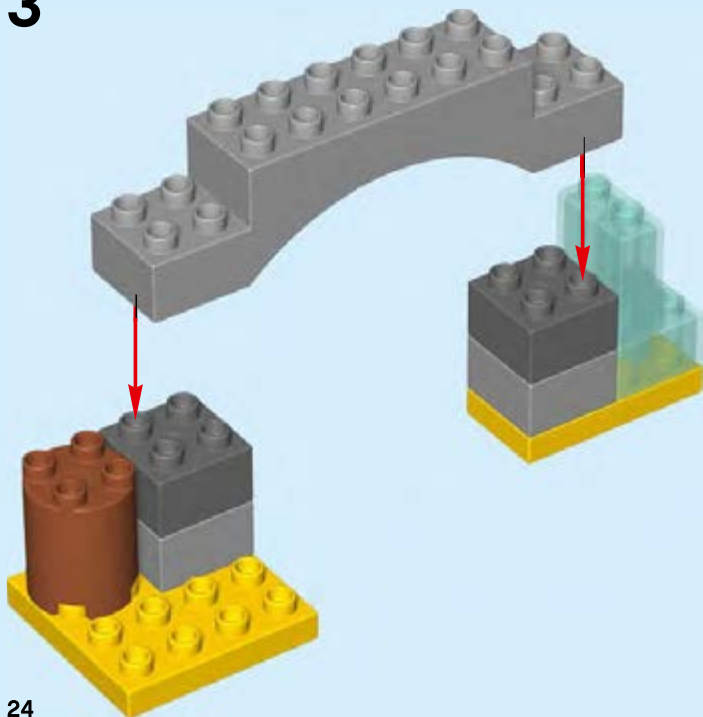

24

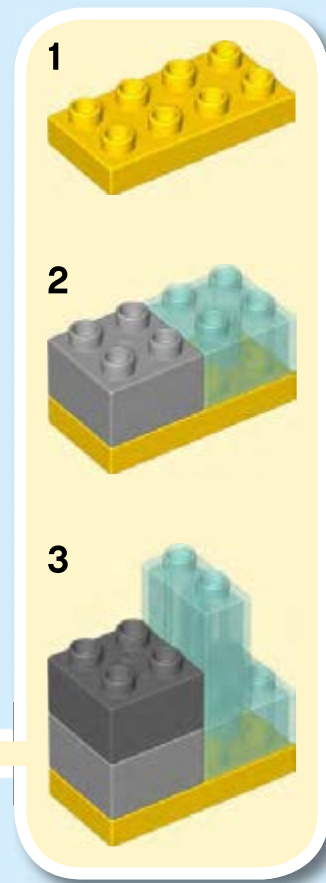

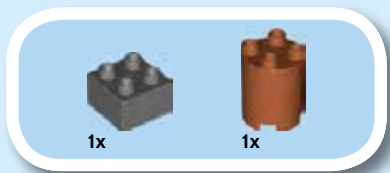

4

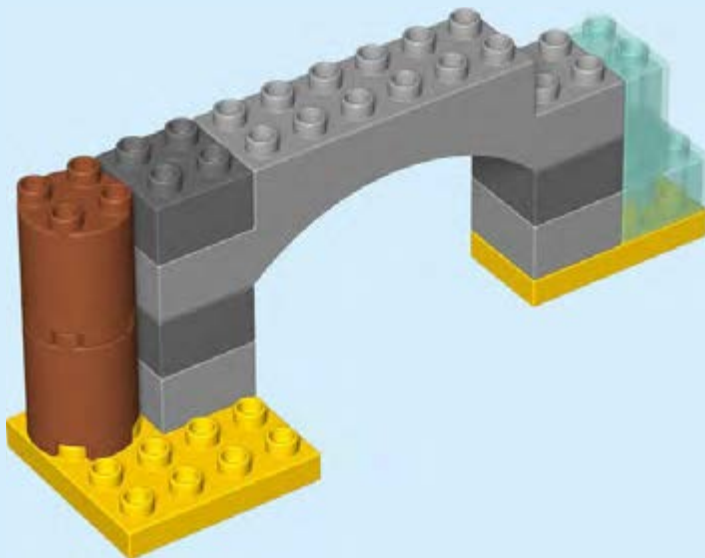

25



5

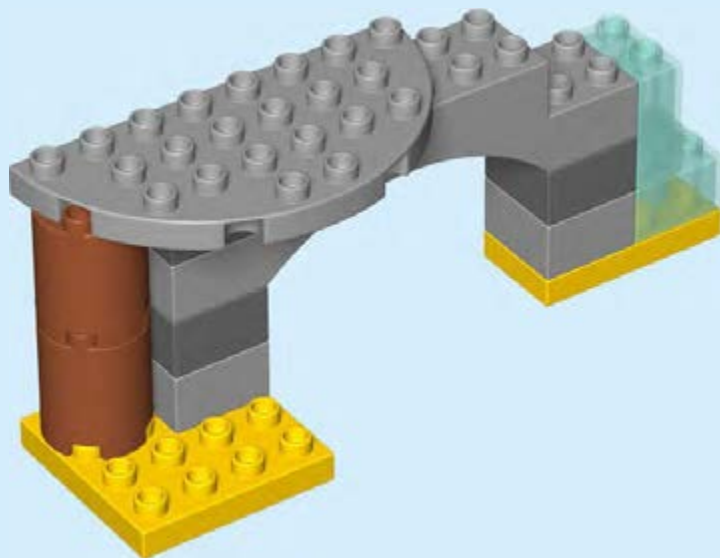

26



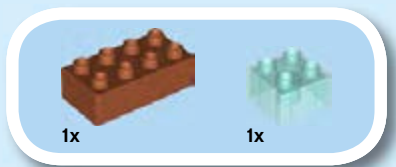

6



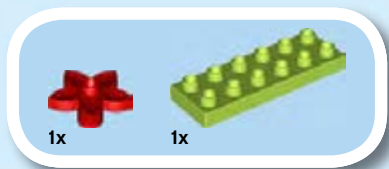

7

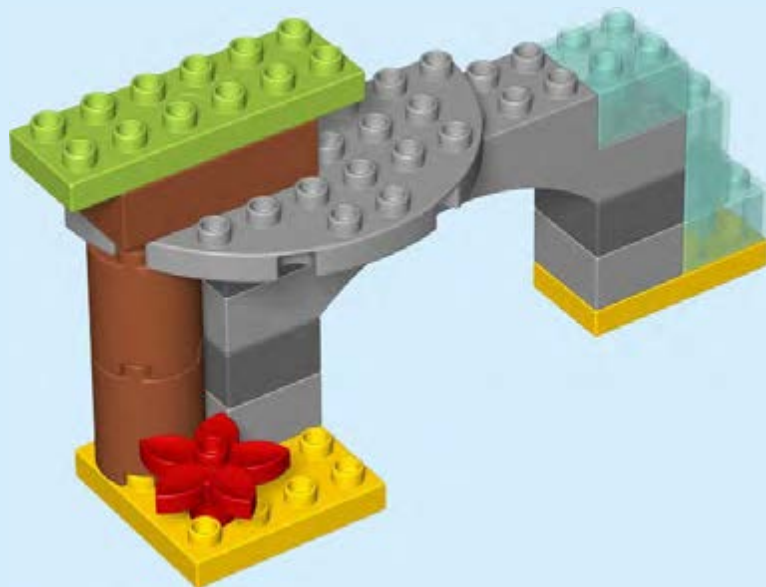

28



8

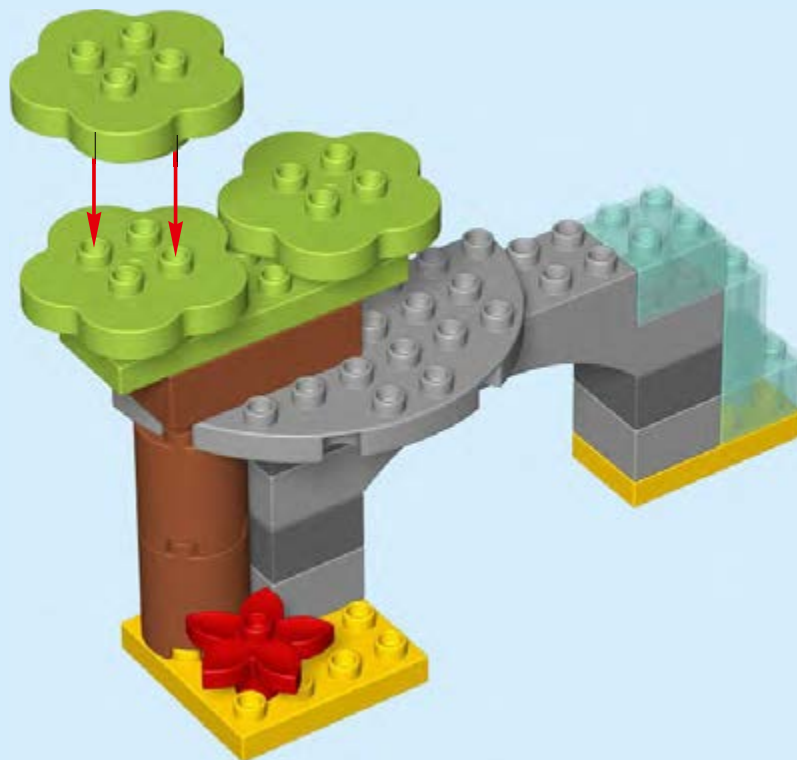

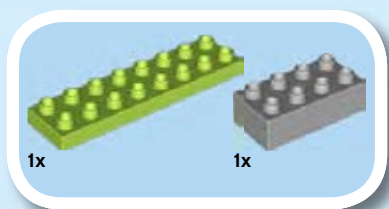

1x

1x

1

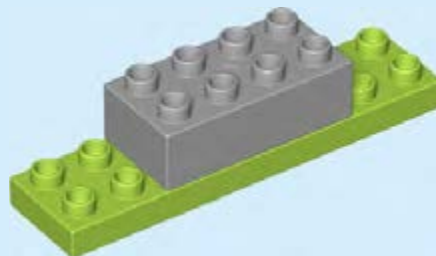

30

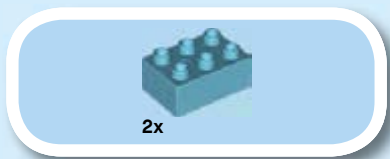

2

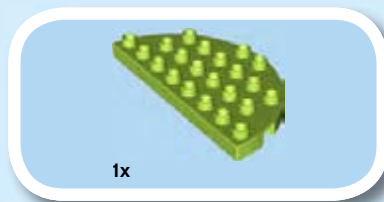
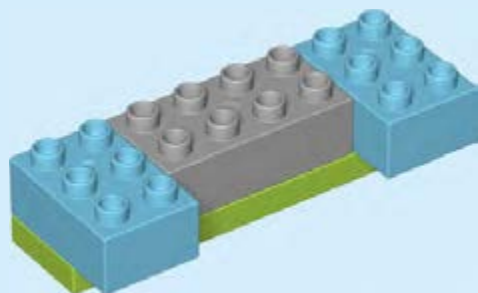

3

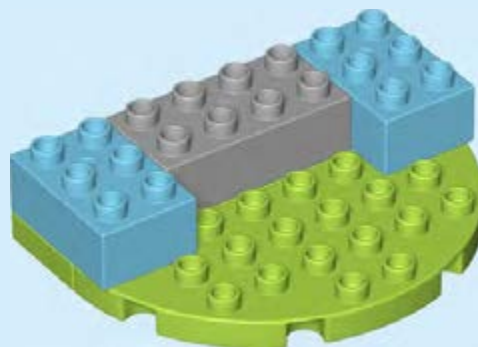

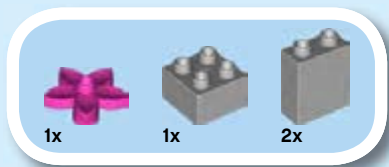

4

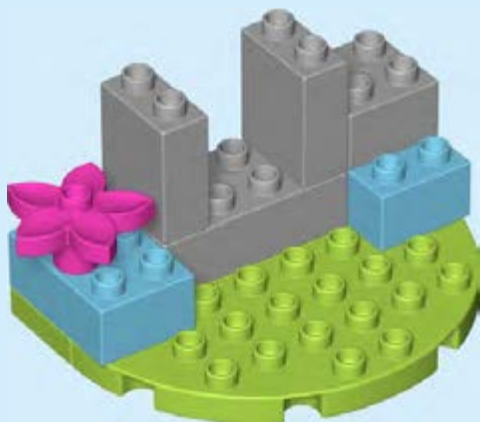

32

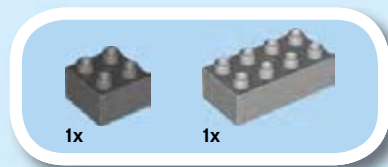

5





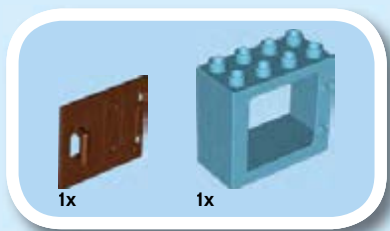

6

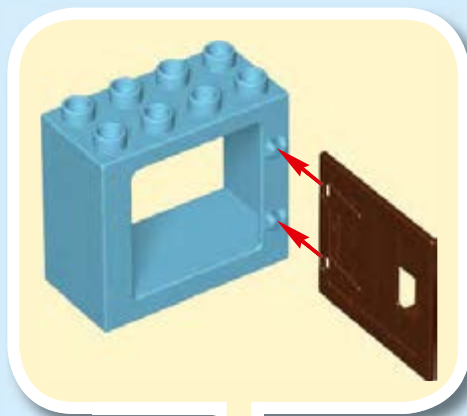



7



34



8





9



10



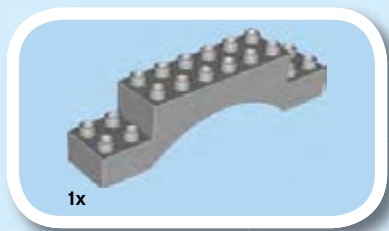

11



36

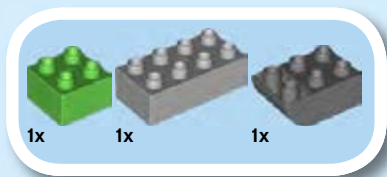

12





13



38



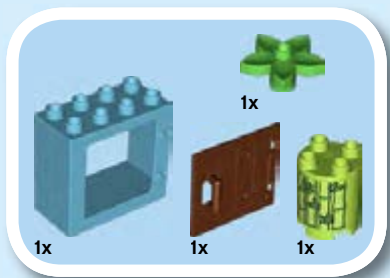

14

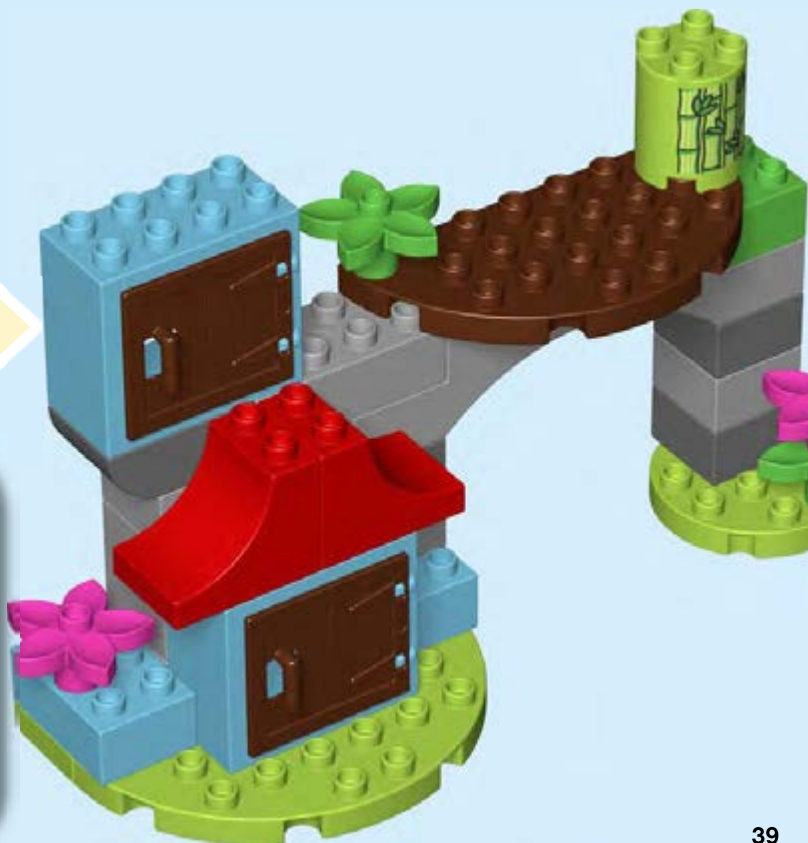

39



15



40



16





  
duplo

The word "duplo" is written in a large, yellow, rounded font with a white outline and a drop shadow. A small red rabbit icon is positioned above the letter 'o'.





# LEGO duplo



**SOCIAL & EMOTIONAL SKILLS**  
Soziale und Emotionale Fähigkeiten  
Aptitudes sociales et émotionnelles  
Capacità emotive e sociali  
Habilidades sociales y emocionales  
Capacidades sociais e emocionais  
Társas és érzelmi készségek  
Sociálās un emocionālās prasmes  
社交与情感技能



**IMAGINATION & CREATIVITY**  
Fantasie und Kreativität  
Imagination et créativité  
Immaginazione e creatività  
Imaginación y creatividad  
Imaginação e criatividade  
Fantázia és kreativitás  
Iztēle un radošums  
想像力和创造力



# duplo

## LEGO® DUPLO® APPS

APPLIS, APP, APPOK  
LIETOTNES, 应用程序



Our games are available for download for both Android and iOS. Unsere Spiele können auf Android- und iOS-Geräte heruntergeladen werden.

Nos jeux peuvent être téléchargés sur Android et iOS.

I nostri giochi sono disponibili sia per Android sia per iOS.

Nuestros juegos se pueden descargar e instalar en dispositivos Android e iOS. O download dos nossos jogos está disponível para Android e iOS.

Játékaink ingyenesen letölthetők Android és iOS eszközökre egyaránt.

Mūsu spēles var lejupielādēt gan Android, gan iOS ierīcēs.

我们的游戏可下载安装于安卓和 iOS 平台。



Customer Service  
Kundenservice  
Service Consommateurs  
Servicio Al Consumidor

LEGO.com/service or dial



: 00800 5346 5555

USA, Canada : 1-800-422-5346





**duplo**



## The fun continues!

Der Spaß geht weiter!

Toujours plus de fun !

Il divertimento continua!

¡La diversión continúa!

A diversão continua!

Újabb érdekességek következnek!

Jautrība turpinās!

欢乐不停歇!

**1½+**



**4+**





1x  
6255014



2x  
343701



1x  
4250172



1x  
6262209



1x  
4222193



3x  
4211754



1x  
6129621

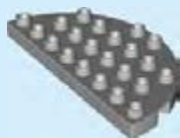

1x  
6187341

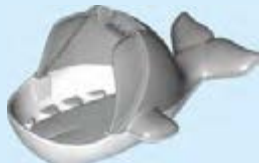

1x  
6129620



2x  
6223716



1x  
6262357



1x  
6265375



2x  
6138409



1x  
6184964



2x  
6137113



1x  
6215346



2x  
6151299



1x  
6250858



1x  
4160152



2x  
6030817



2x  
4100853



1x  
6265759



1x  
6265293



1x  
6263777



1x  
6259327



1x  
4100774



4x  
230121



1x  
6145943



4x  
6033052



1x  
6094178



3x  
4158534



1x  
6094187



1x  
4158386



1x  
6263021



3x  
6263779



3x  
6054622



1x  
4185178



1x  
6208323



1x  
6249381

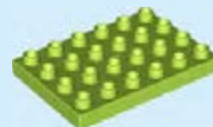

1x  
6208515



1x  
6138112

46



1x  
6187321



1x  
6201043



6x  
6094052



2x  
4121575



3x  
4168579



1x  
6263781

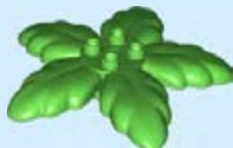

1x  
4121576



1x  
6263782



1x  
6028006



1x  
6095870



2x  
6184970



4x  
4266228



7x  
4210953



1x  
6252919



3x  
4224735



1x  
6210314



3x  
6201835



1x  
6259183



1x  
6104418



1x  
6262260



1x  
6214593



2x  
6016315



1x  
6266800



1x  
6194070



1x  
6268360



1x  
6264312



1x  
6273387



1x  
6266937



1x  
6265055



1x  
6264273



1x  
6266771



1x  
6262266



1x  
6266766



1x  
6263784



1x  
6093976



1x  
6214939

Customer Service

Kundenservice

Service Consommateurs

Servicio Al Consumidor

LEGO.com/service or dial



: 00800 5346 5555

: 1-800-422-5346

# win

Go to [www.LEGO.com/productfeedback](http://www.LEGO.com/productfeedback) and  
give us your short **feedback** about  
this LEGO® DUPLO® set for a chance  
to win a cool LEGO prize

Terms & Conditions apply



## LEGO.com/productfeedback

### GEWINNE

Erzähle uns auf  
[www.LEGO.com/productfeedback](http://www.LEGO.com/productfeedback)

etwas über die Erfahrungen, die du mit  
diesem LEGO® Set gemacht hast, und  
sichere dir die Chance auf einen coolen  
LEGO Preis!

Es gelten die Teilnahmebedingungen

### GAGNE

Rends-toi sur  
[www.LEGO.com/productfeedback](http://www.LEGO.com/productfeedback)

et donne-nous quelques commentaires  
sur ce produit LEGO® pour avoir une  
chance de gagner un prix LEGO !

Voir Conditions Générales

### GANA

Visita  
[www.LEGO.com/productfeedback](http://www.LEGO.com/productfeedback)

y envíanos tu opinión acerca de este set  
LEGO®. ¡Participarás en el sorteo de un  
premio LEGO!

Términos y Condiciones aplicables

### 获取奖品

登录  
[www.LEGO.com/productfeedback](http://www.LEGO.com/productfeedback)

给出关于此乐高®套装的简短反馈，  
就有机会获得炫酷乐高奖品

《条款及条件》适用

LEGO, the LEGO logo and DUPLO are trademarks of the LEGO Group. ©2019 The LEGO Group.

6296224