



duplo



10932
LEGO.com/DUPLO





1

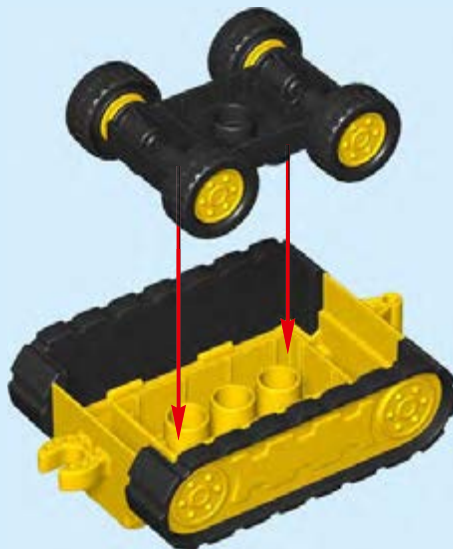

2



4



3



4



5

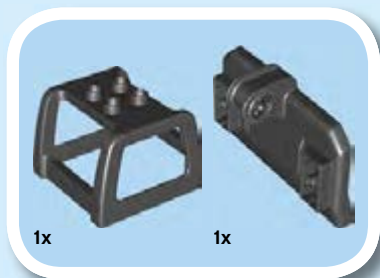

5



6



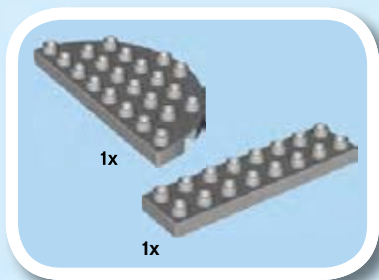

1

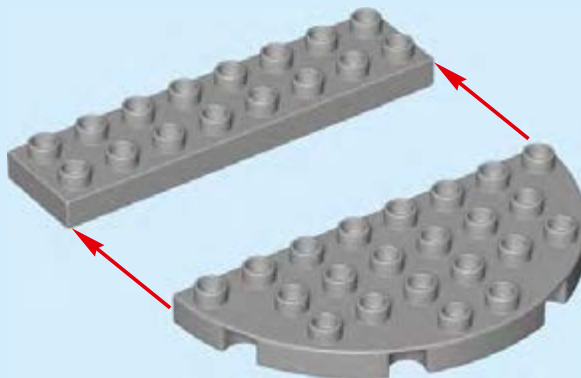

8



2





3



10



4

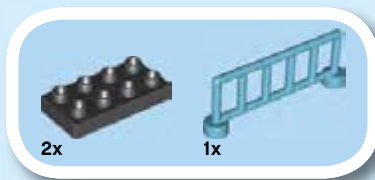
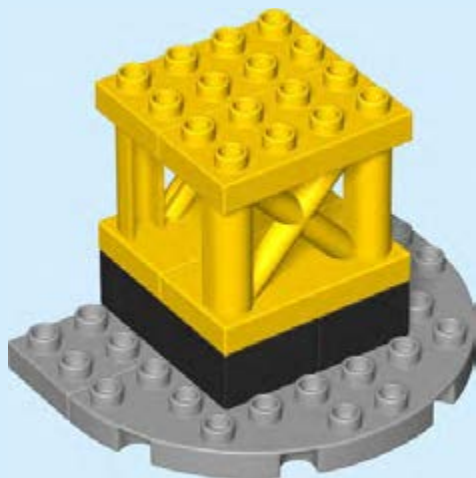

5

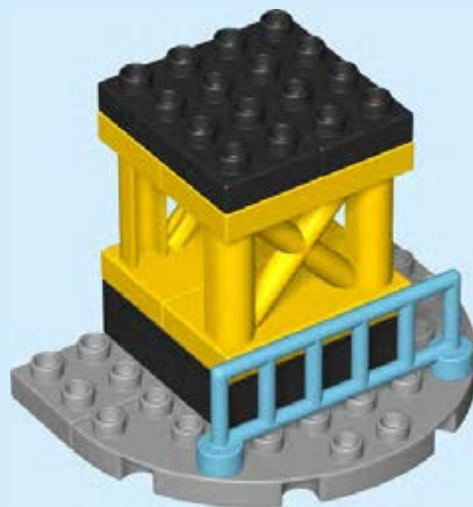



6



12



2x

7



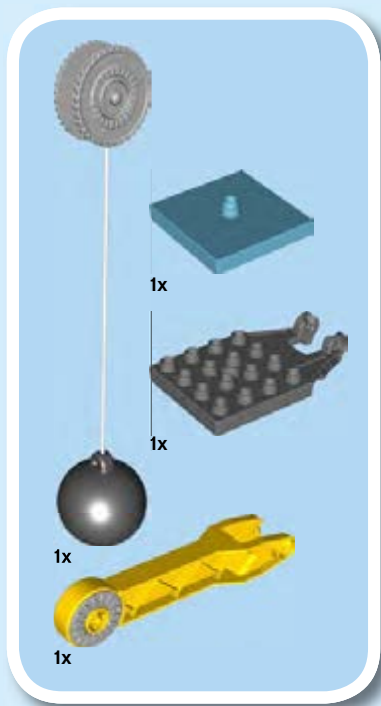

8

1

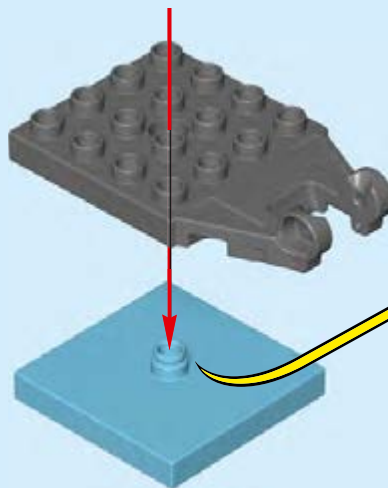

CLICK KLIKK
CLIC CLIQUE
KATT KLIKSKIS
卡塔

2

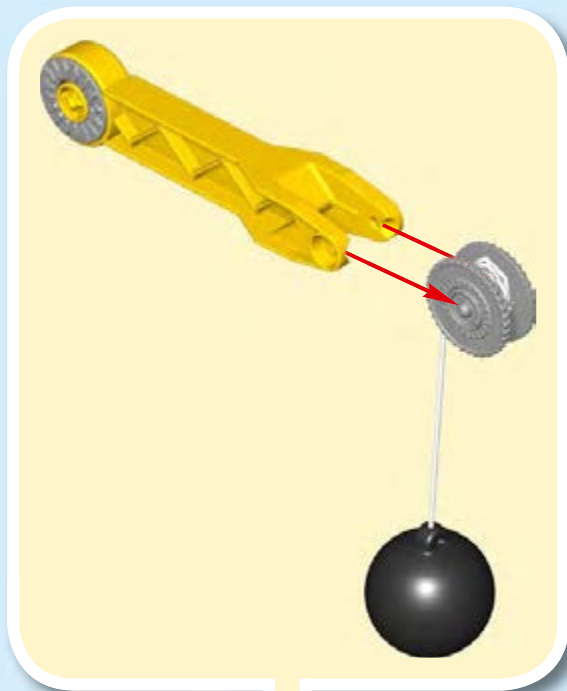
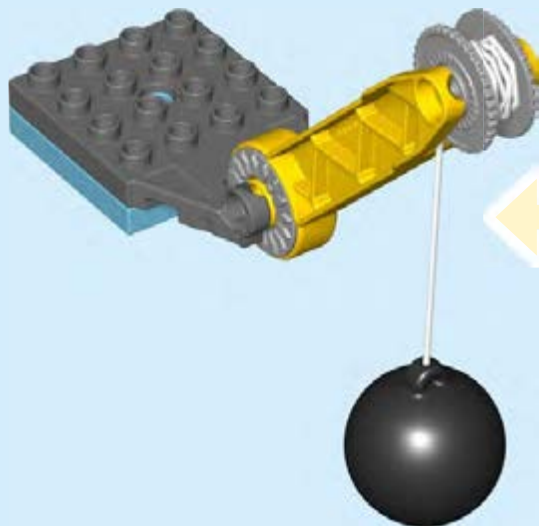

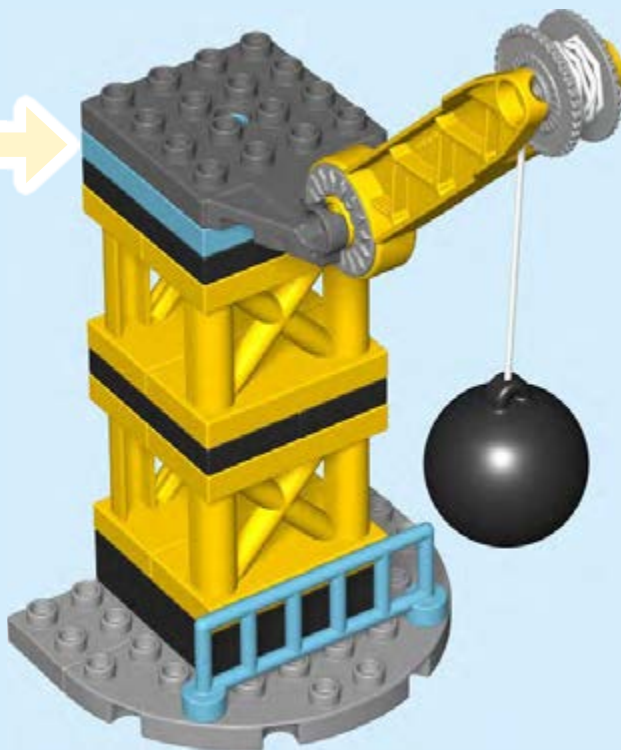

16



9

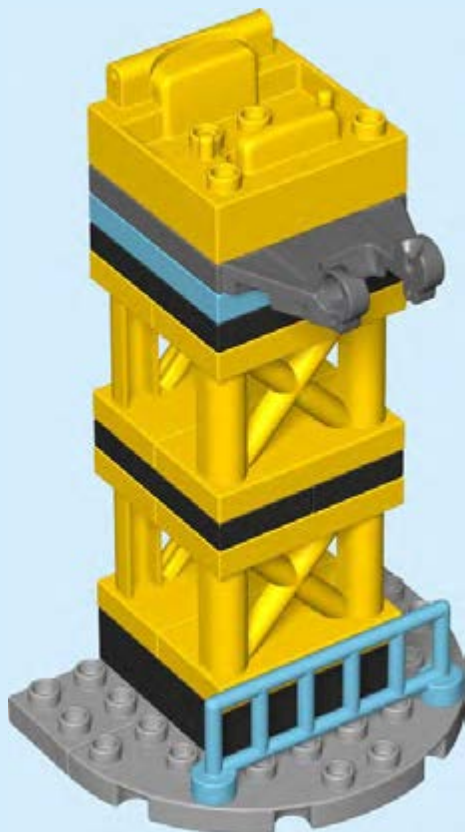



10

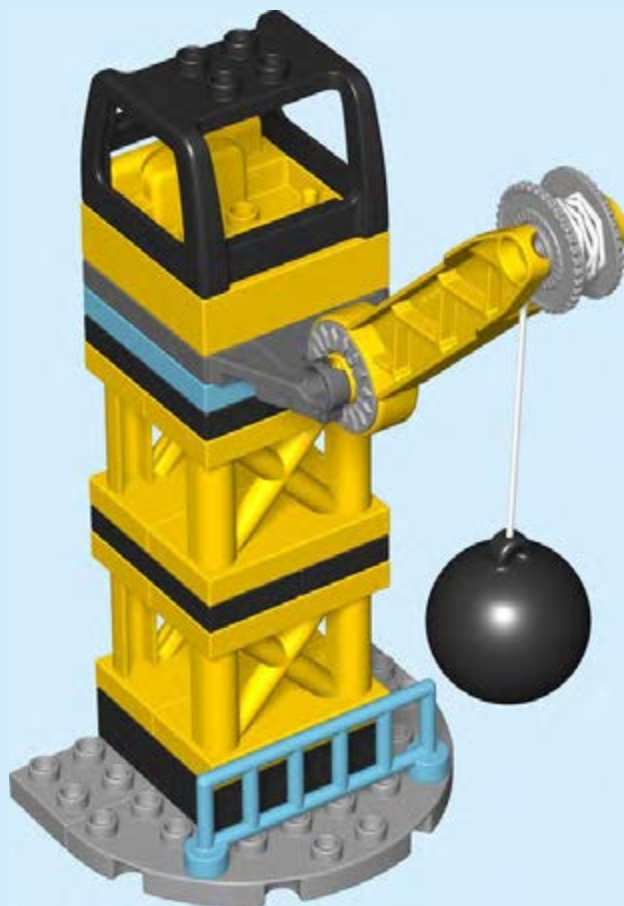

18



1x

11

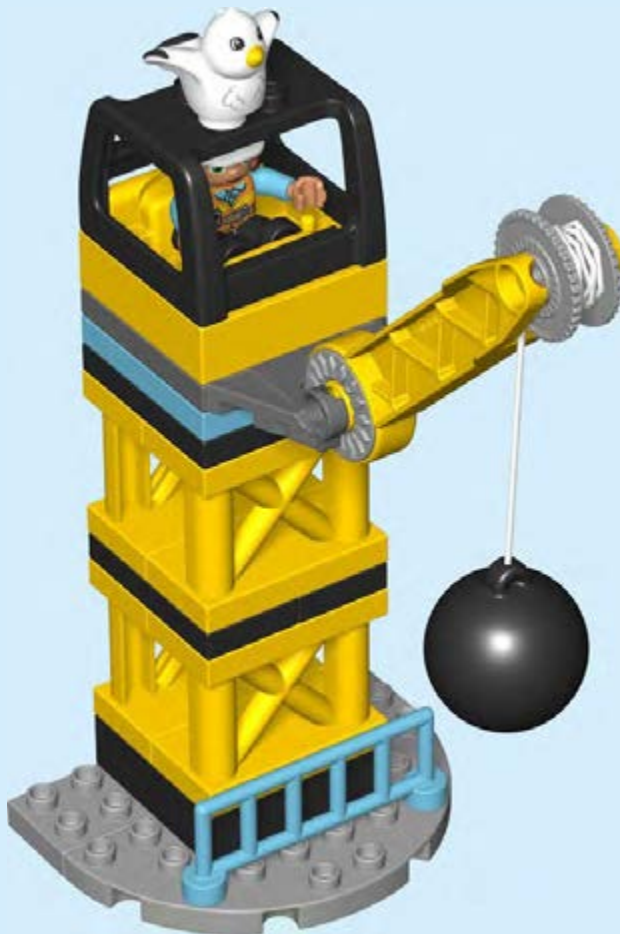

19



2x

1

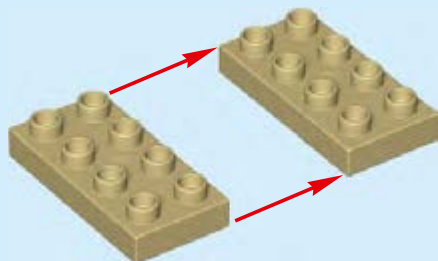

20

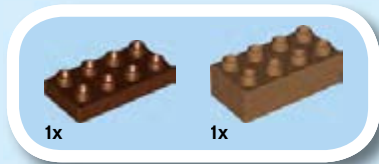

1x

1x

2

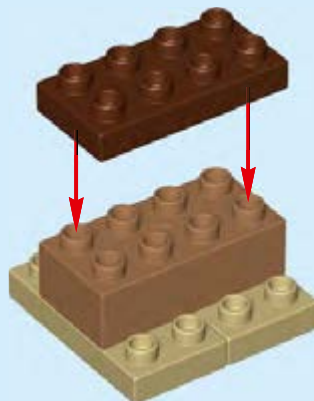

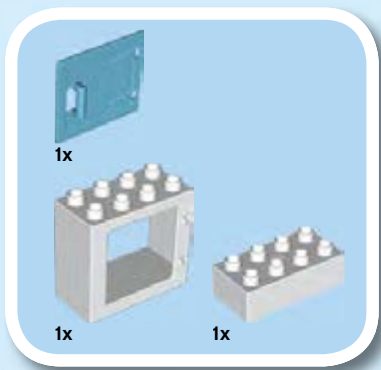

3

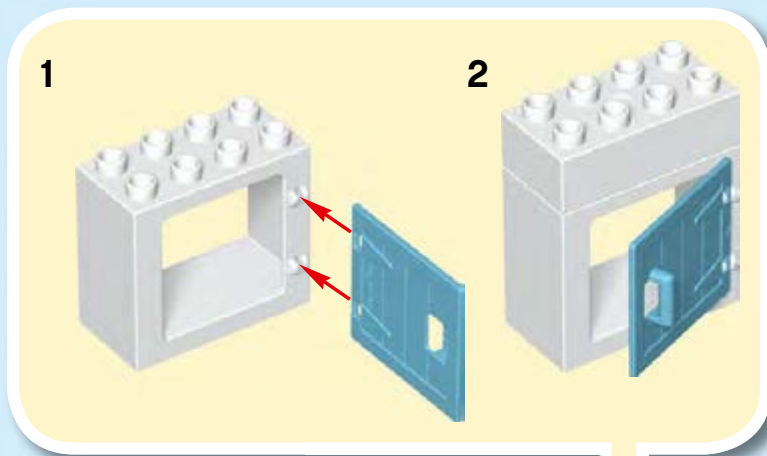



4

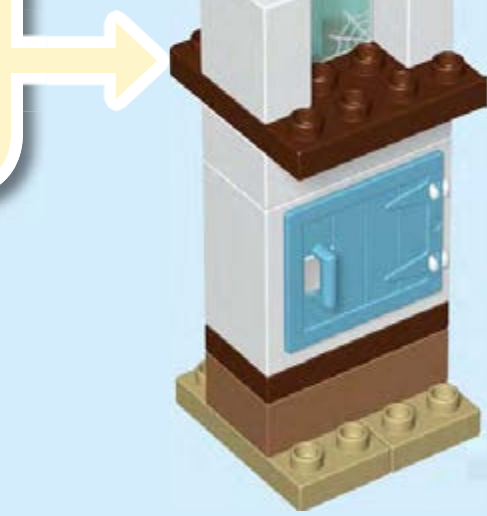
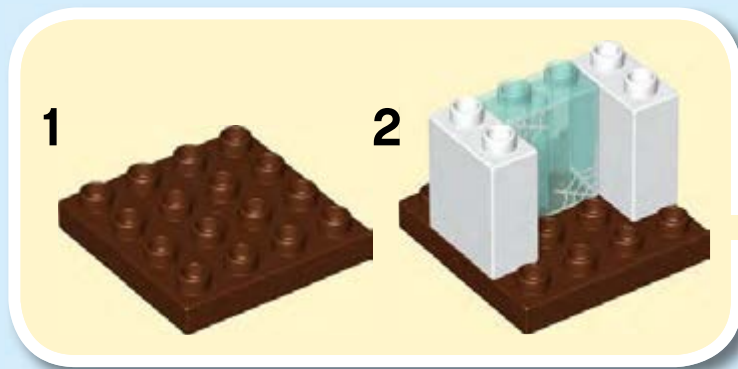



5



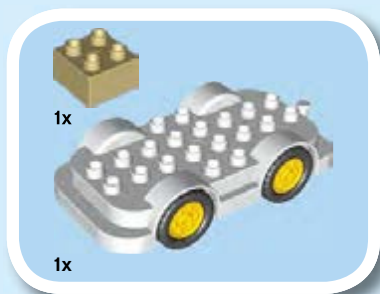

1



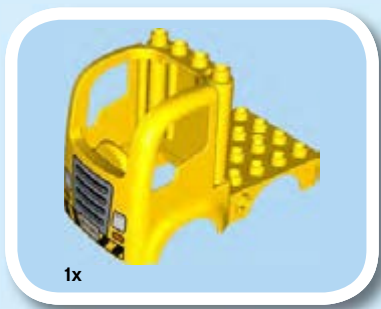

2





3



26

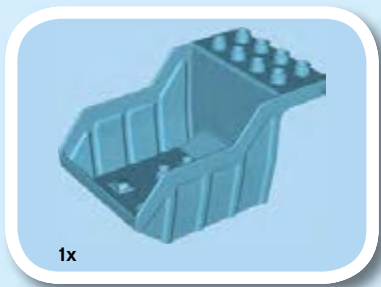

1x

4





5





6



29



duplo



10915
Age 1½+

Age

1½

EXTRA
IDEAS
INCLUDED



10913
Age 1½+

Extra Ideas Included
Mit zusätzlichen Bauldeen
Idées supplémentaires incluses
Idee aggiuntive incluse
Incluye ideas extra
Inclui Ideias Extra
Extra ötletek a csomagban
Iekļautas papildu idejas
内含更多创意

LIGHT
BRICK



10933
Age 2+

2+

LIGHT &
SOUND

LIGHT &
SOUND

PUSH
& GO



Light brick
Leuchtbaustein
Brique lumineuse
Mattoncino luminoso
Ladrillo luminoso
Peça luminosa
Világító elem
Gaismas klucītis
发光积木

Push & Go
Actionné par poussée
Told és indul
Inceres motors
一推就走

Light & sound
Licht und Ton
Luci e suoni
Luz y sonido
Luz e som
Fény és hang
Gaismas un skaņas
声效与光效



duplo

A WORLD OF LEGO® DUPLO®

EINE LEGO® DUPLO® WELT / LE MONDE DE LEGO®
DUPLO® / UN MONDO DI LEGO® DUPLO® / UN MUNDO
DE LEGO® DUPLO® / UM MUNDO DE LEGO® DUPLO® /
A LEGO® DUPLO® VILÁGA / LEGO® DUPLO® PASAULE

丰富多彩的乐高®得宝®世界



The availability of apps is subject to the local strategies of the LEGO Group.
Die Verfügbarkeit der Apps unterliegt der Strategie der LEGO Gruppe für das jeweilige Land.

La disponibilité des applications est soumise aux stratégies locales du groupe LEGO.
La disponibilità dell'app è soggetta alle strategie locali del LEGO Group.

La disponibilidad de las apps está sujeta a las estrategias regionales de The LEGO Group.
A disponibilidade das apps está sujeita às estratégias locais do Grupo LEGO.



Az alkalmazások elérhetőségét a LEGO Csoport helyi stratégiája határozza meg.
Lietotņu pieejamība ir atkarīga no LEGO Group vietējās stratēģijas.

相关应用是否在当地发行取决于乐高集团在当地的市场策略



Customer Service
Kundenservice
Service Consommateurs
Servicio Al Consumidor

LEGO.com/service or dial

 : 00800 5346 5555
 : 1-800-422-5346



Go to www.LEGO.com/productfeedback
win
 and give us your short
feedback about this
 LEGO® DUPLO® set for a chance to win
 a cool LEGO prize

Terms & Conditions apply

LEGO.com/productfeedback

GEWINNE

Erzähle uns auf
www.LEGO.com/productfeedback

etwas über die Erfahrungen, die du mit diesem LEGO® Set gemacht hast, und sichere dir die Chance auf einen coolen LEGO Preis!

Es gelten die Teilnahmebedingungen

GAGNE

Rends-toi sur
www.LEGO.com/productfeedback

et donne-nous quelques commentaires sur ce produit LEGO® pour avoir une chance de gagner un prix LEGO !

Voir Conditions Générales

GANA

Visita
www.LEGO.com/productfeedback

y envíanos tu opinión acerca de este set LEGO®. ¡Participarás en el sorteo de un premio LEGO!

Términos y Condiciones aplicables

获取奖品

登录
www.LEGO.com/productfeedback

给出关于此乐高®套装的简短反馈，就有机会获得炫酷乐高奖品

《条款及条件》适用

LEGO, the LEGO logo and DUPLO are trademarks of the LEGO Group. ©2020 The LEGO Group.

6321016