

KASPIAN

S128-REG2W2S

A	B	C	D	
1	S128 0002	822	176	3/4
2	S128 023	1468	408	4/4
3	S128 024	1468	408	4/4
4	S128 105	1964	396	1/4
5	S128 106	1964	396	1/4
6	S128 209	900	399	2/4
7	S128 316	862	370	2/4
8	S128 326	863	370	2/4
9	S128 401	863	60	2/4
10	S128 902	1935	893	1/4
11	S128 9926	780	348	1/4
12	BP 503	350	120	2/4
13	BP 504	350	120	2/4
14	ZP 5503	770	120	2/4

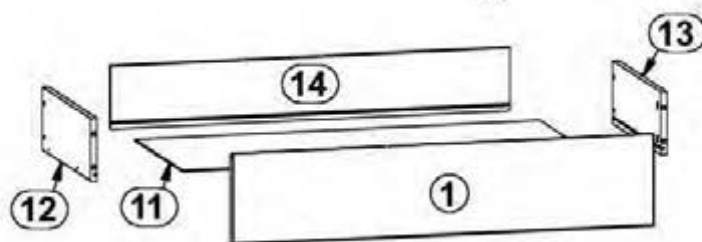
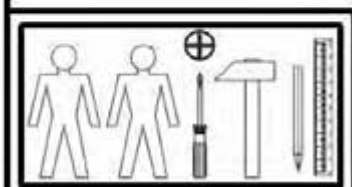
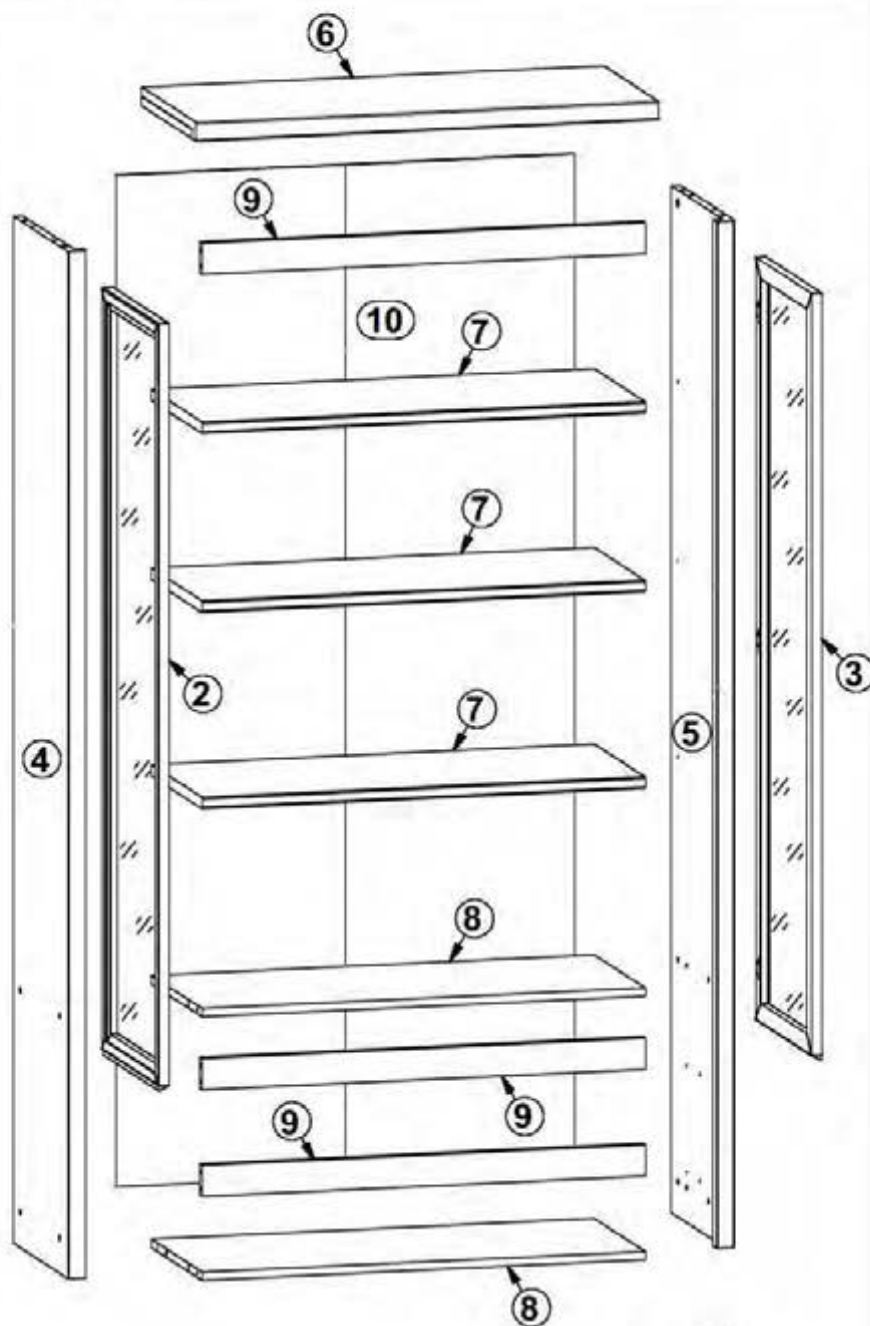
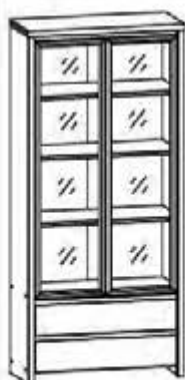

6x a1	6x b12	6x b8	12x d1 ø5x17 mm	8x e1 ø7.5x30 mm	12x e16 ø6.3x30 mm	8x e19 ø6x30 mm	12x e23 ø6.5x30 mm	24x f1 ø6x30 mm
8x f25 ø4.5x40 mm	4x k1	65x l1	4x p25 ø4.5x17 mm	12x r1 ø1.5x12mm x1.5	12x r42	8x s1	2x s2 ø16	2x t19 Ø19 mm
12x w36 ø12 mm	2x w45 CL 350 mm	2x w45 CR 350 mm	2x w45 DL 350 mm	2x w45 DR 350 mm	1x z1	1x n2611	1x p38 ø5.5x10 mm	

1

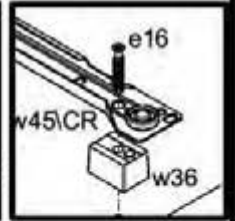
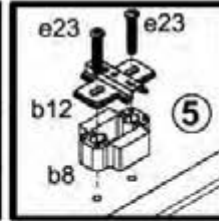
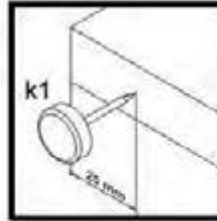
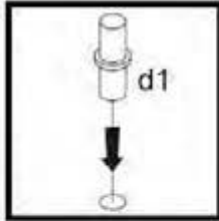
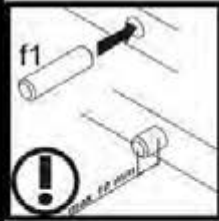
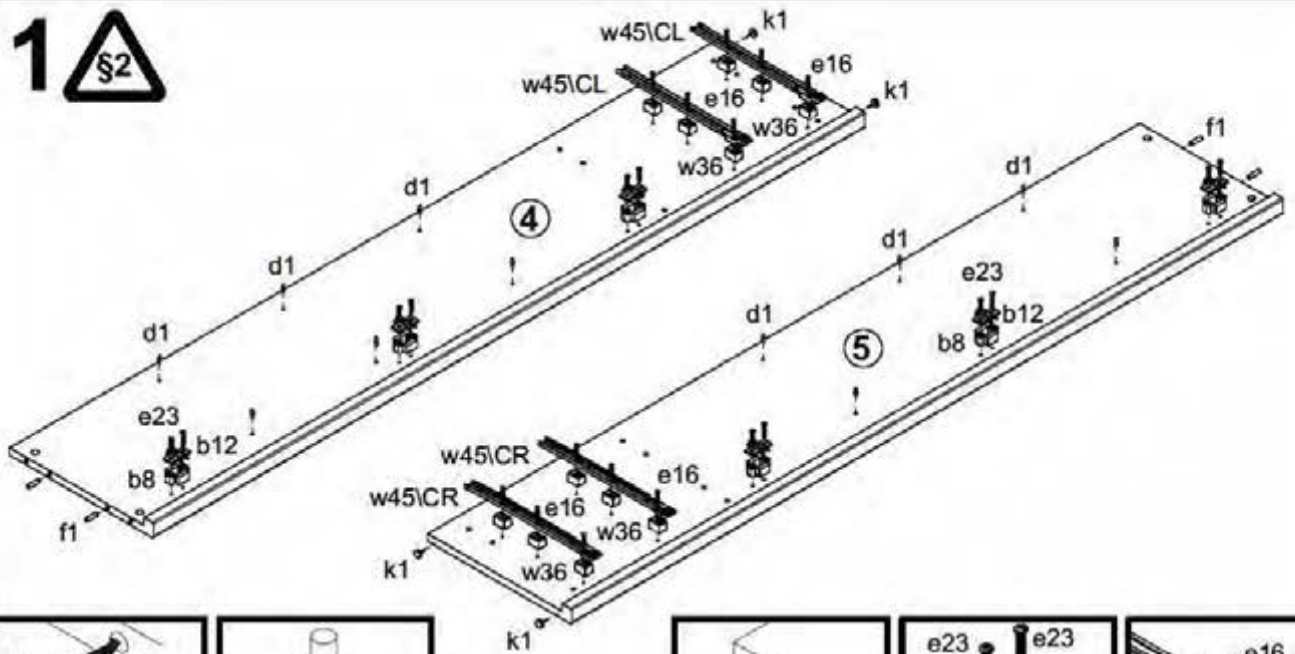

2

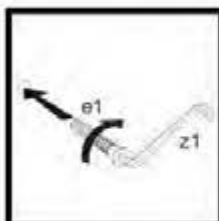
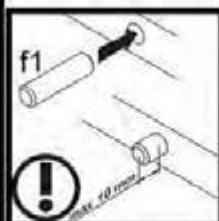
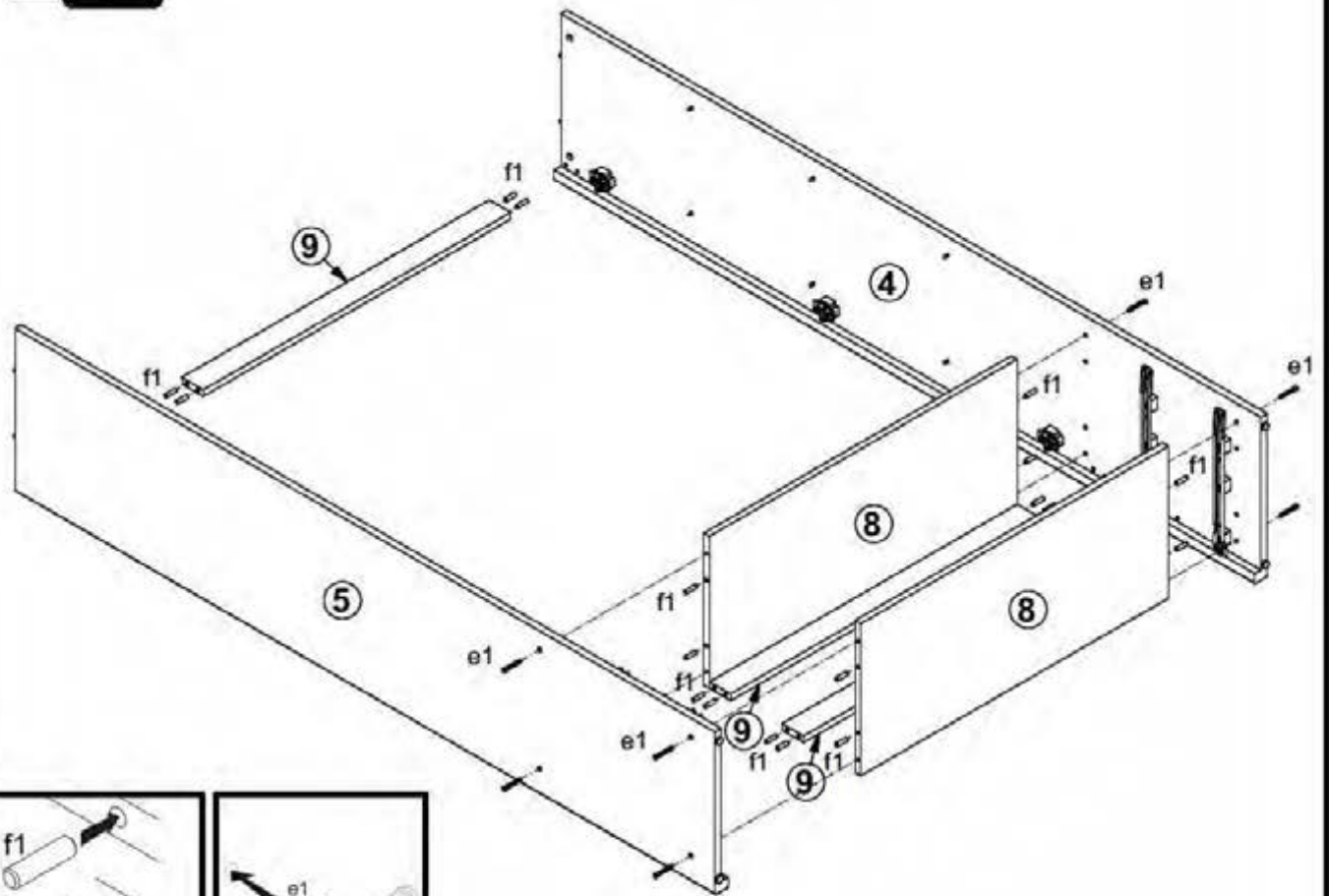

3

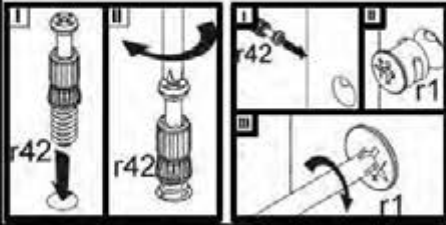
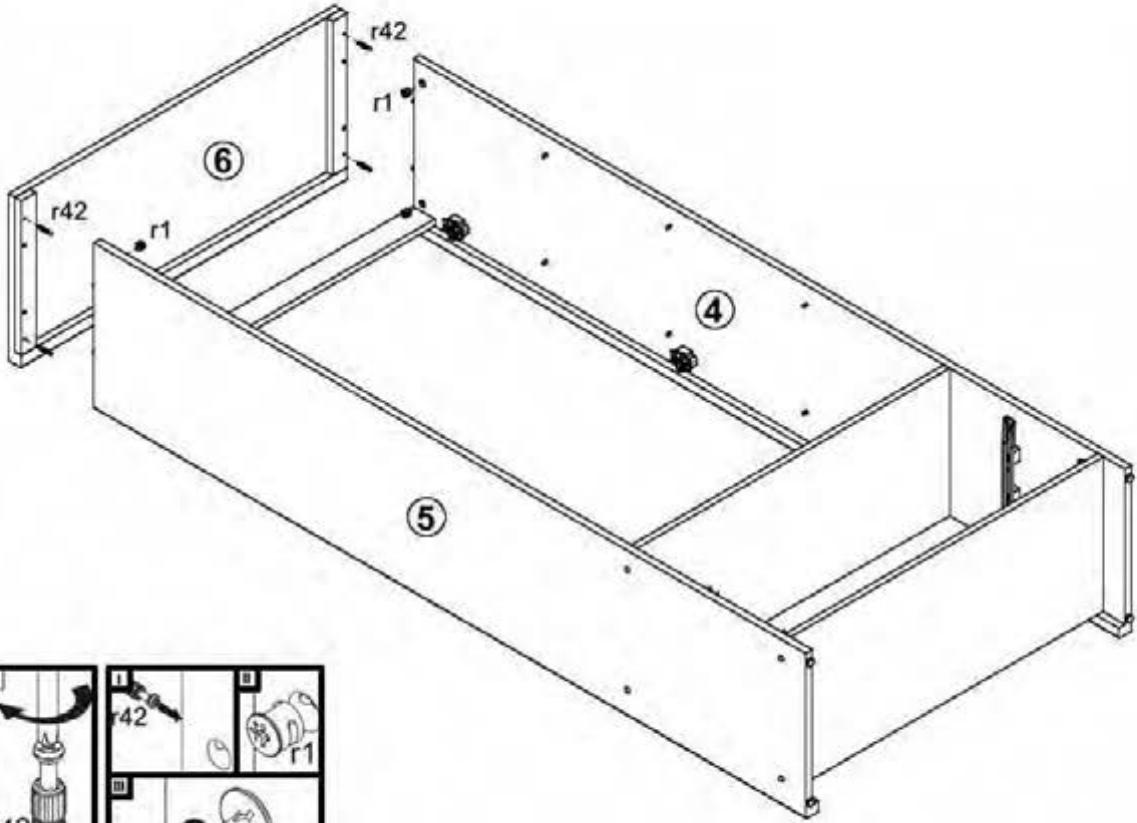

4

