

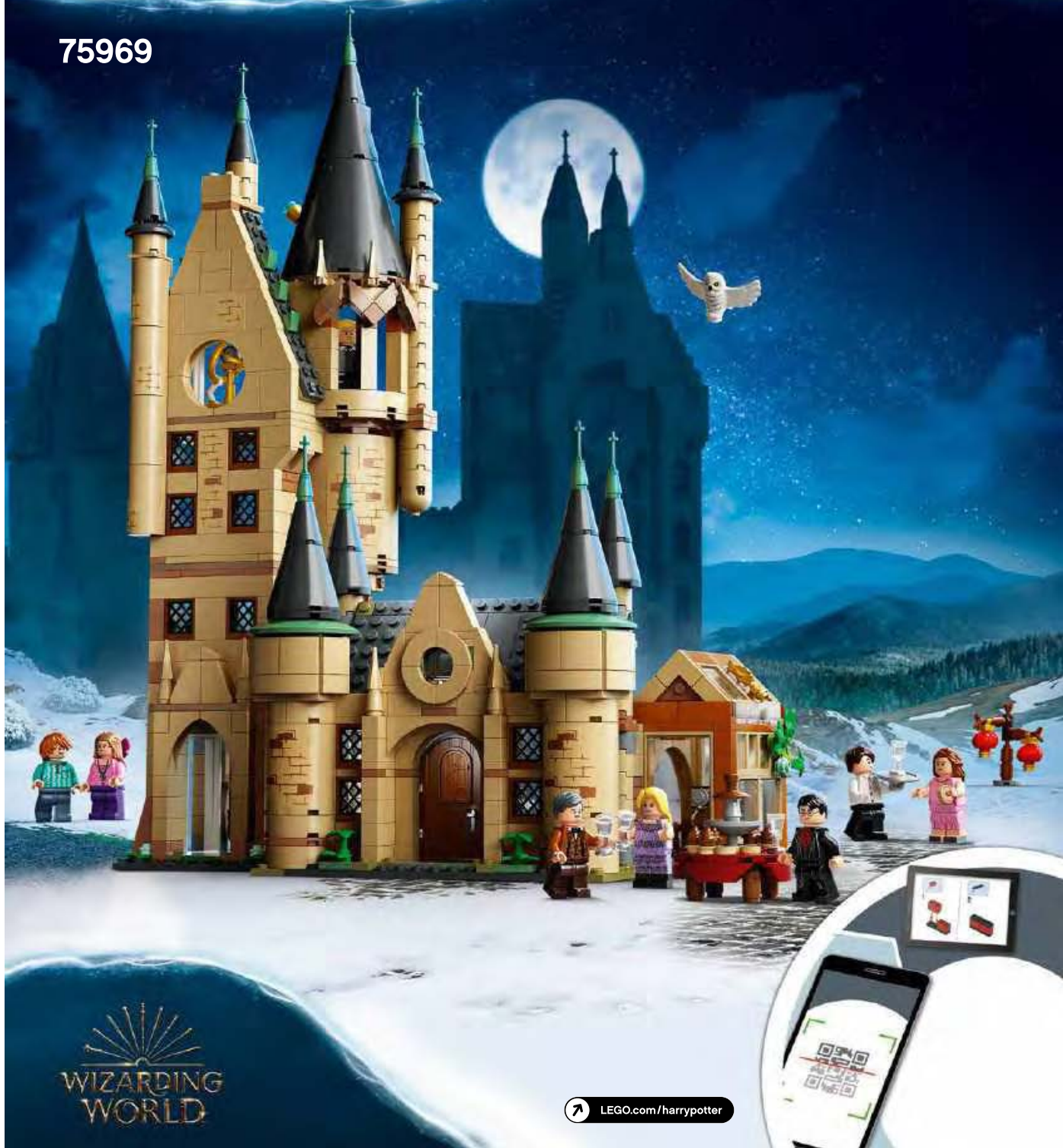

# Harry Potter

75969



WIZARDING  
WORLD

 [LEGO.com/harrypotter](https://www.lego.com/harrypotter)

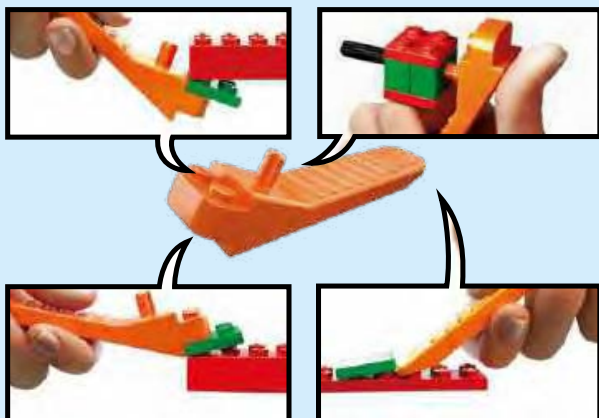
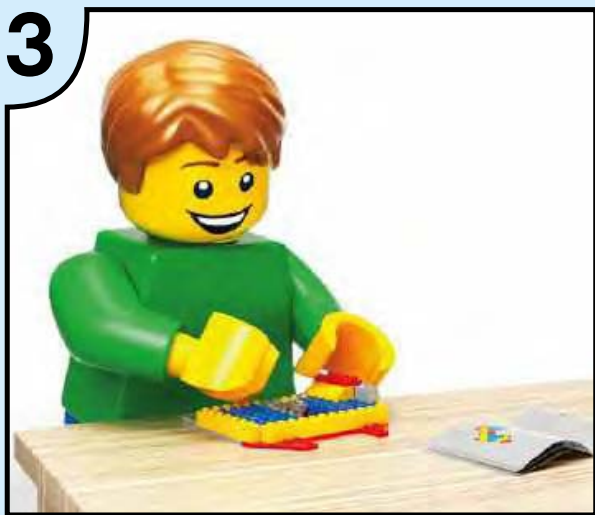

[LEGO.com/brickseparator](https://lego.com/brickseparator)



- 1 Scan the code on the front cover  
Scanne den Code auf der Titelseite  
Scanne le code sur la page de couverture  
Scanner le code sur la page couverture  
Scansiona il codice sulla copertina  
Escanea el código de la portada  
Faz scan do código na frente da capa  
Olvasd be a borítón látható kódot!  
Noskenē kodu uz priekšējā vāka  
扫描封面上的二维码



- 2 Get the Building Instructions  
Hol dir die Bauanleitung  
Obtiens les instructions de montage  
Obtenir les instructions de montage  
Scarica le istruzioni per la costruzione  
Consulta las instrucciones de construcción  
Obtém as Instruções de Construção  
Szerezd be az építési útmutatókat!  
Saņem būvēšanas instrukcijas  
获取拼搭说明

**LEGO.com/apps**

Check for compatibility  
Kompatibilität prüfen  
Vérifier la compatibilité  
Controlla la compatibilità  
Comprueba tu compatibilidad  
Verificar a compatibilidade  
Ellenőrizd a kompatibilitást  
Pārbaudīt saderību  
检查兼容性



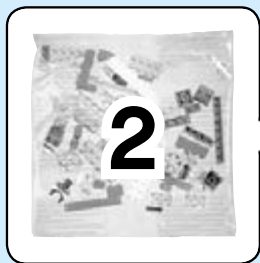



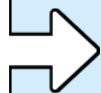
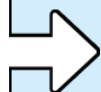
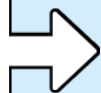

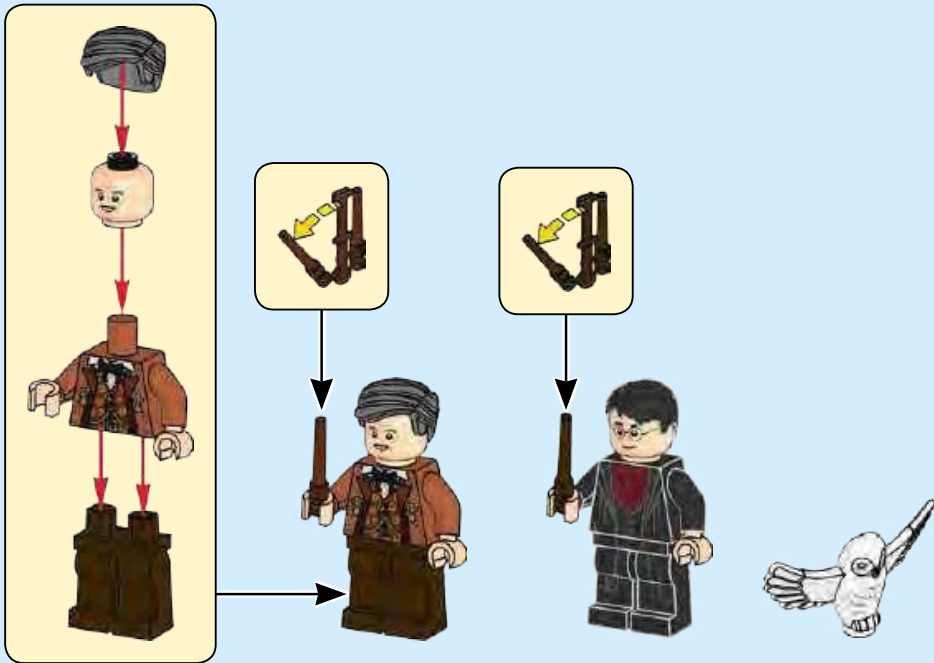
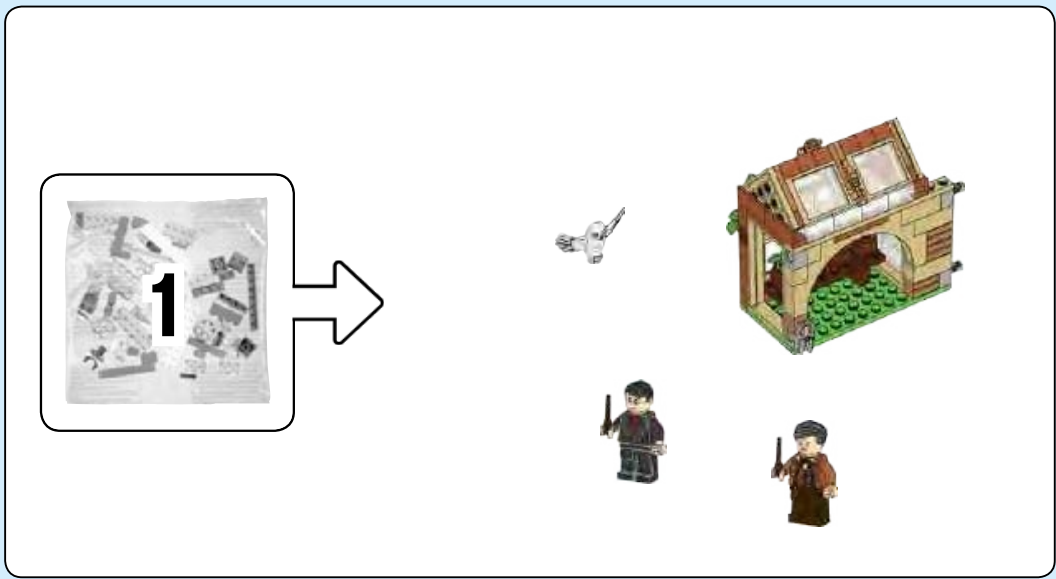

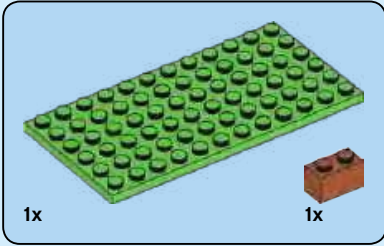

1

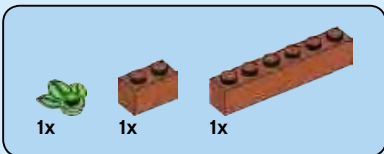
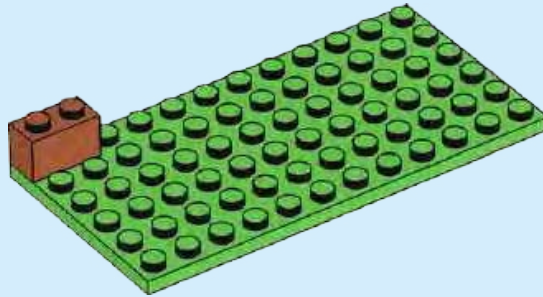

2

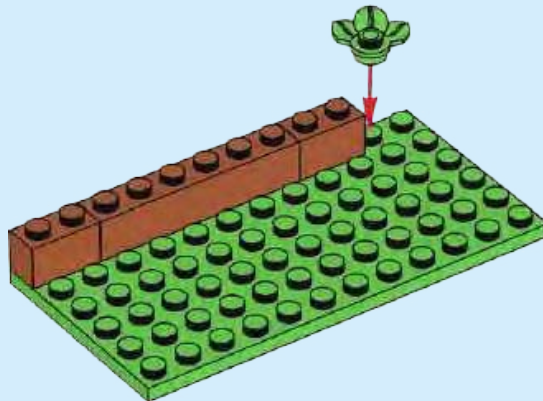



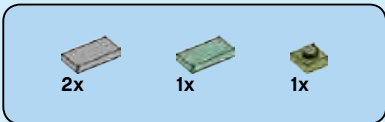

3

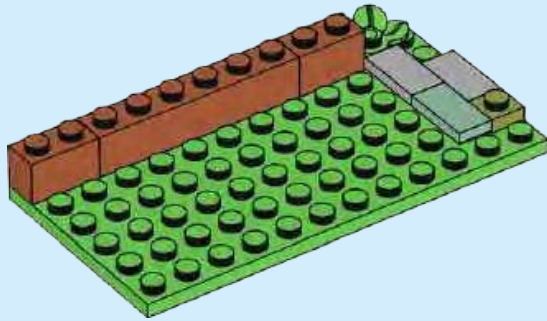

4

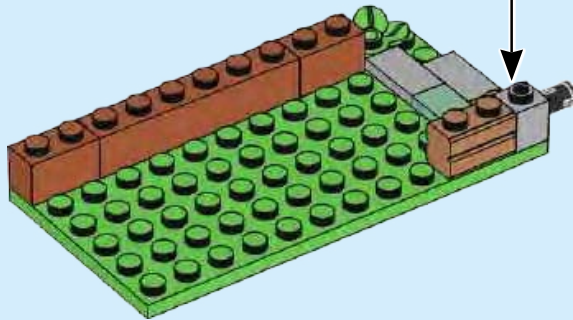
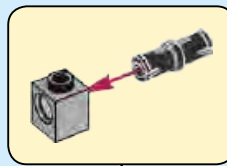

8



5

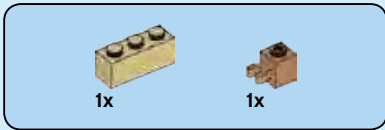
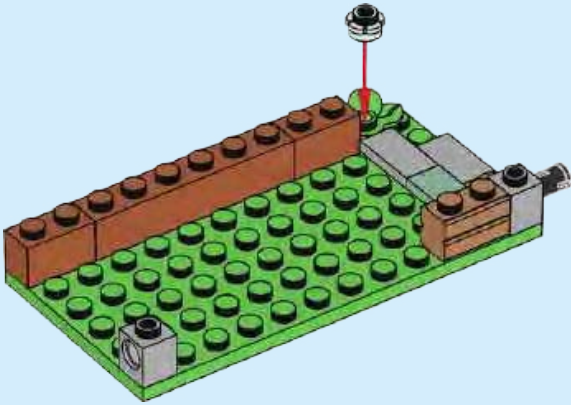

6

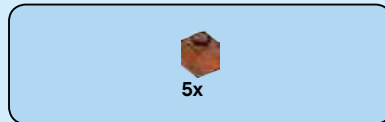
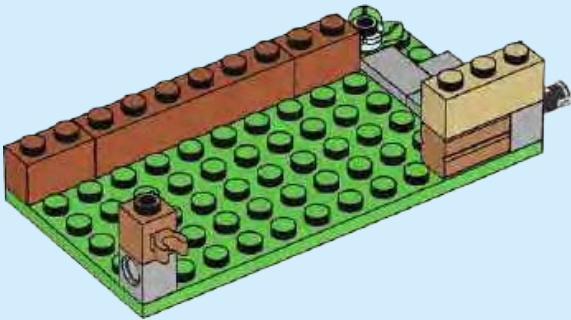

7

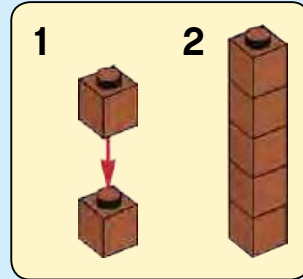

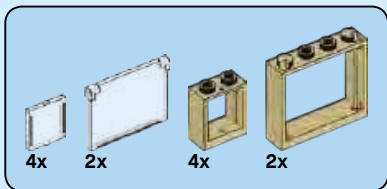

8

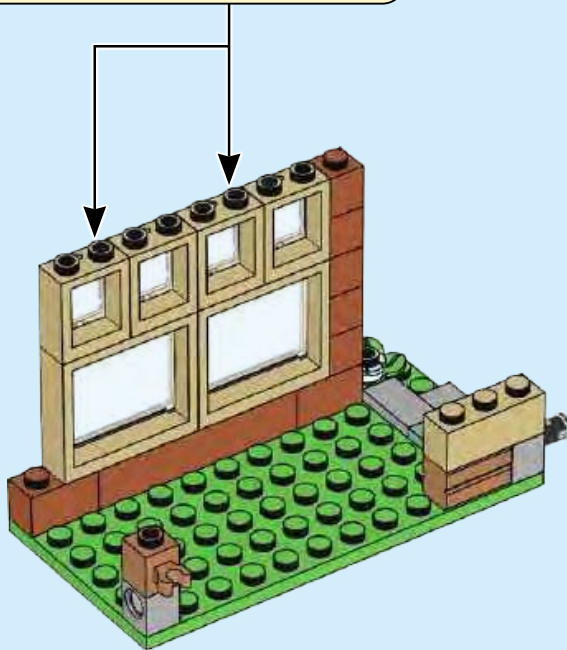
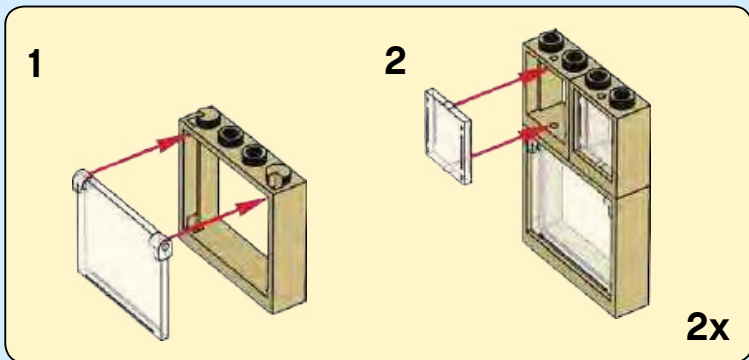





9

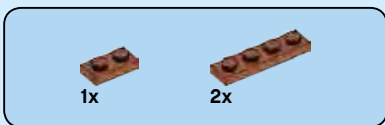
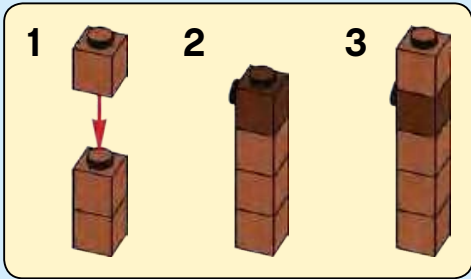

10



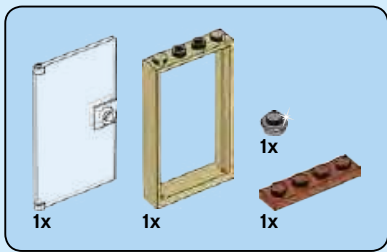

11

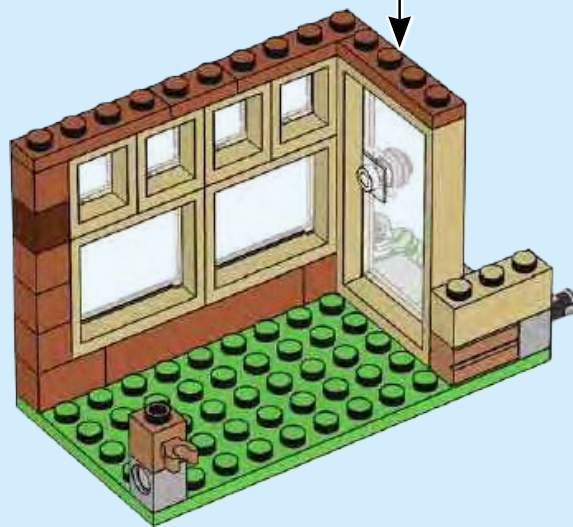
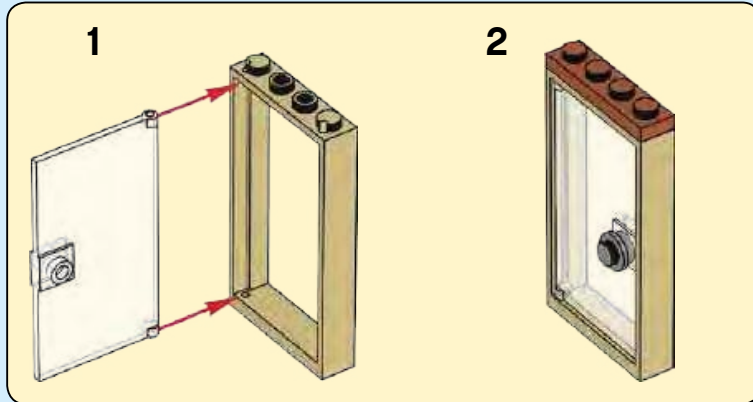

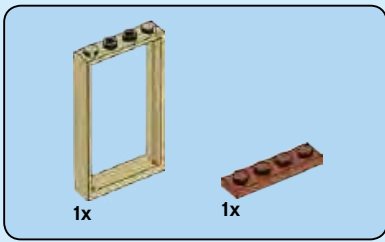

12

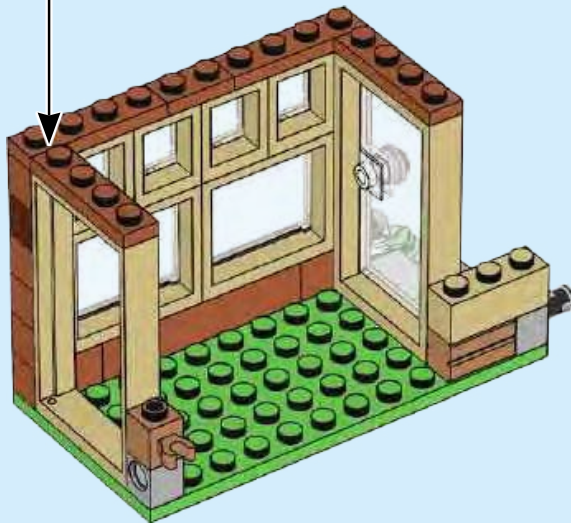
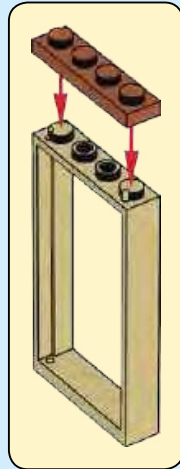



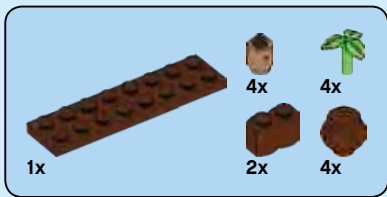

13

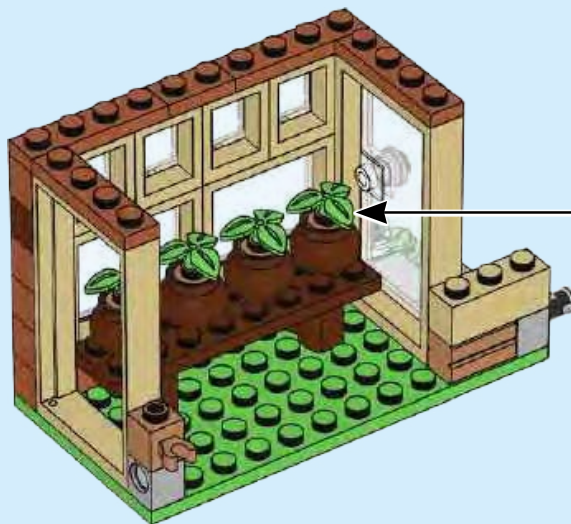
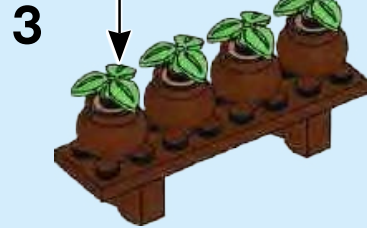
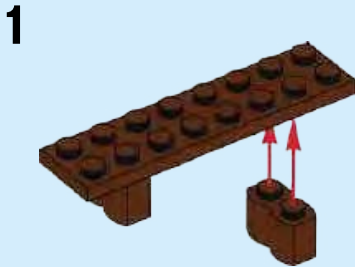
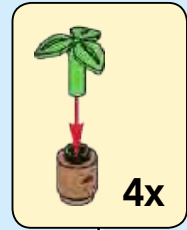

14

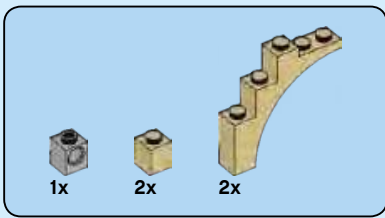

14

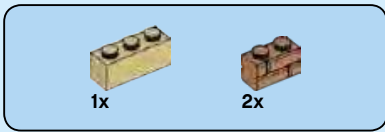
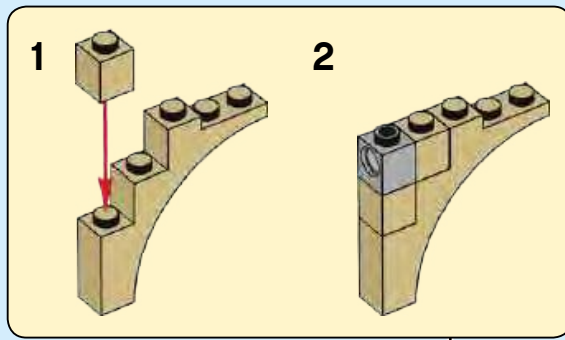

15

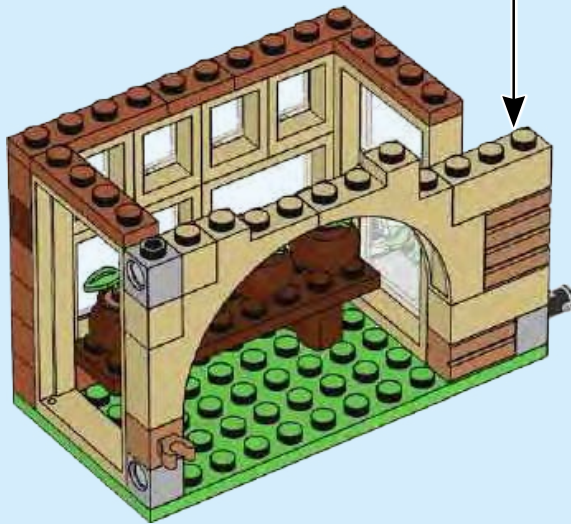
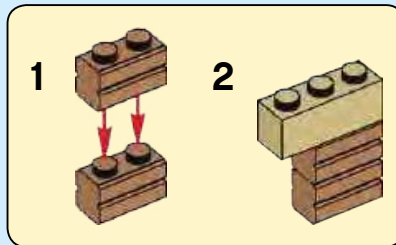

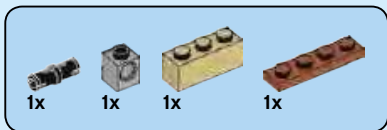

16

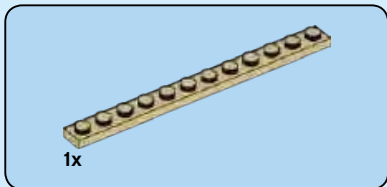
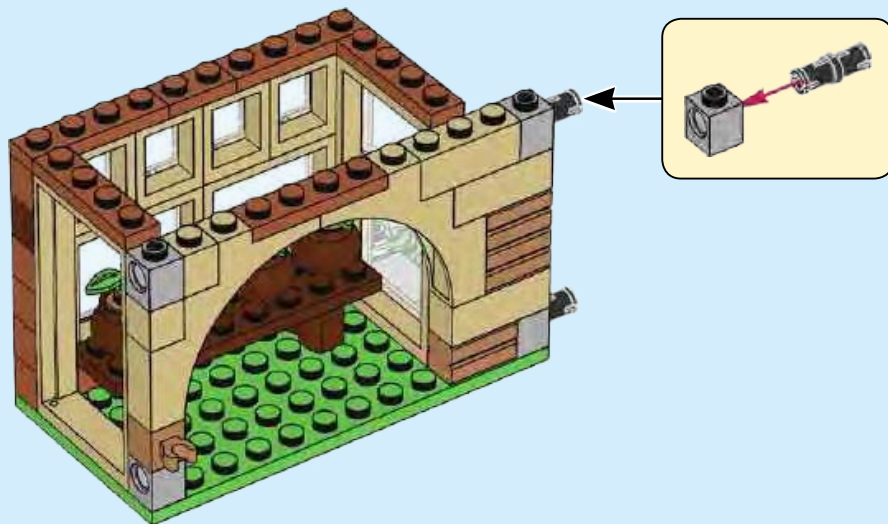

17



16

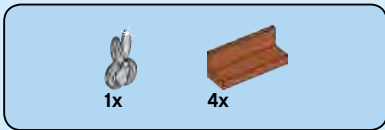

18

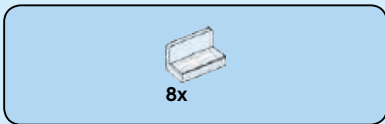
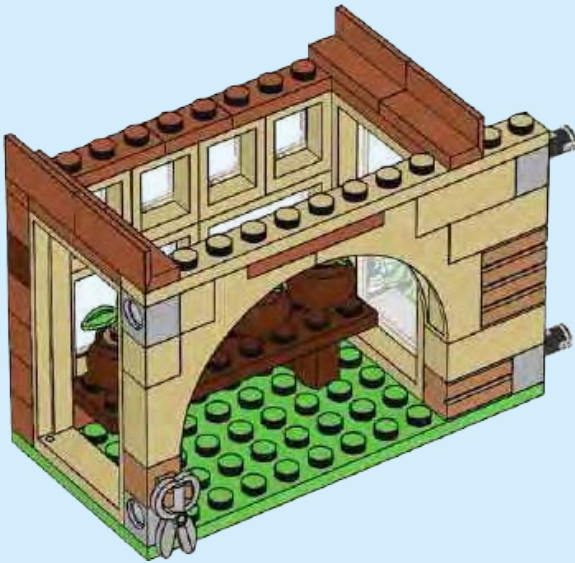

19

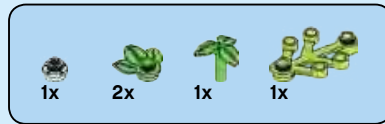
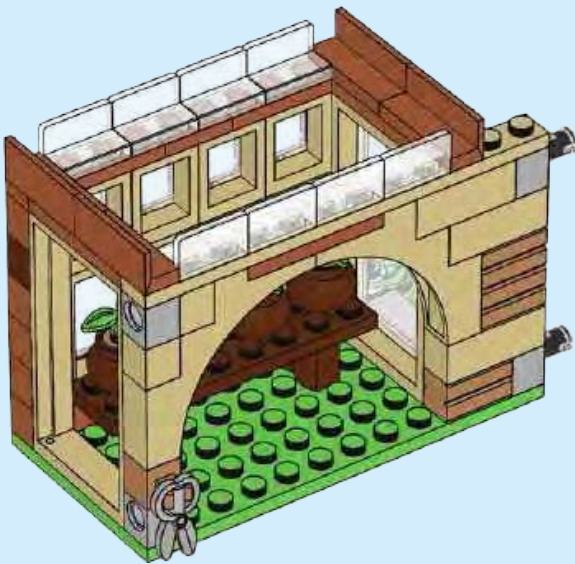

20

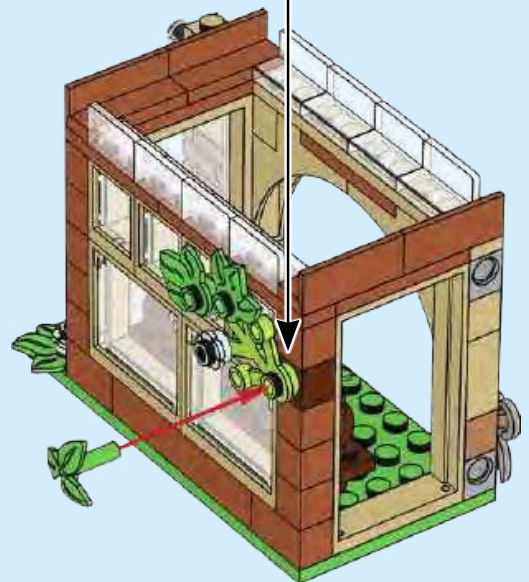
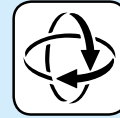



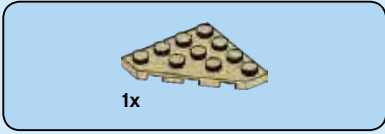

21

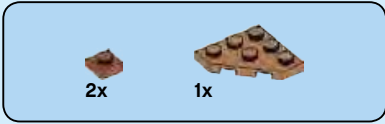
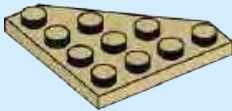

22

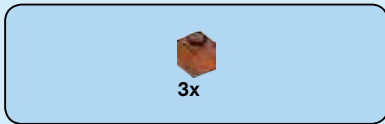
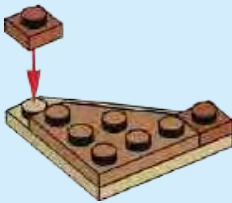

23

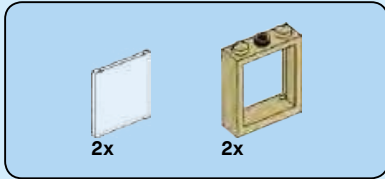
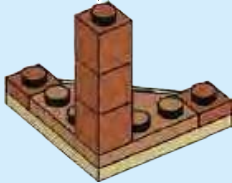
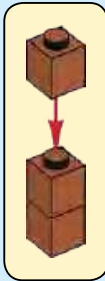

24

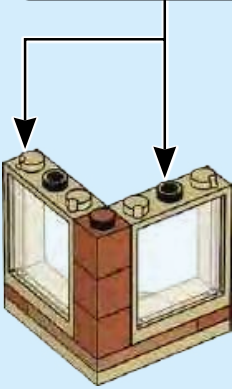
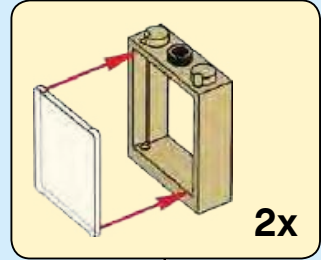



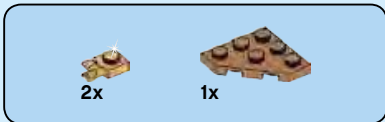

25

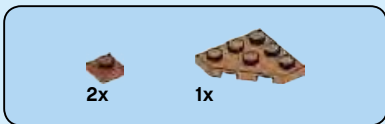
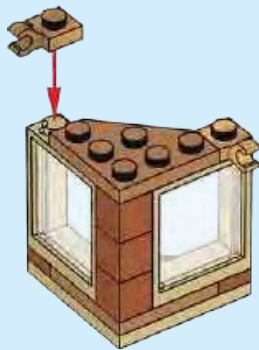

26

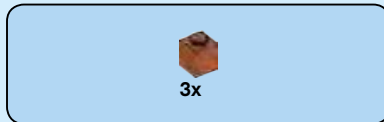
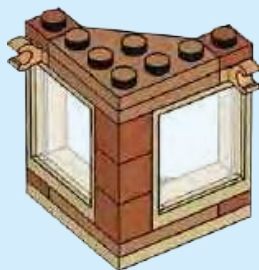

27

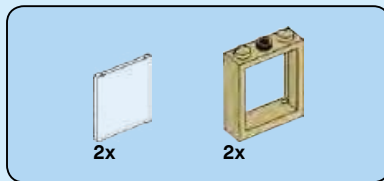
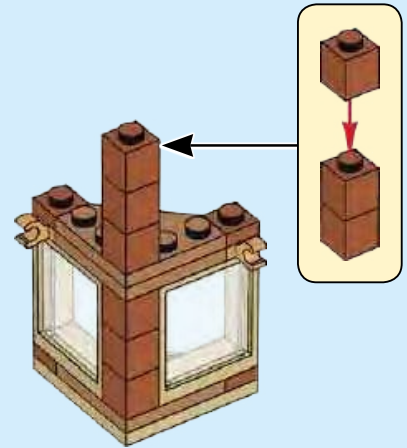

28

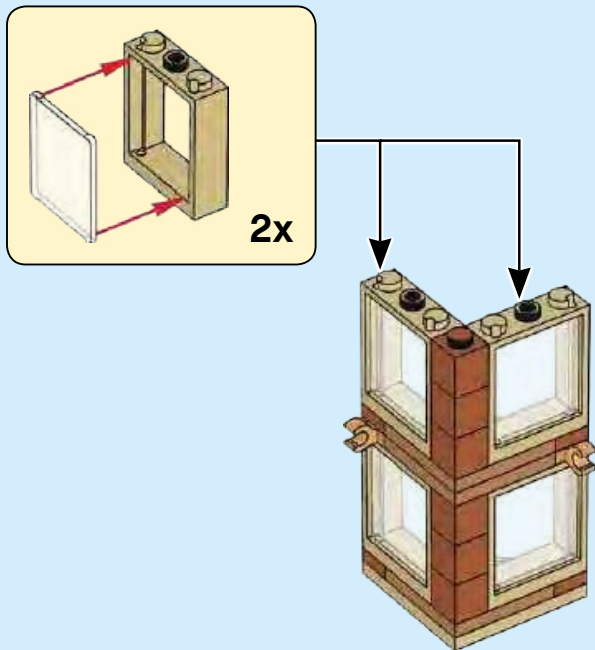

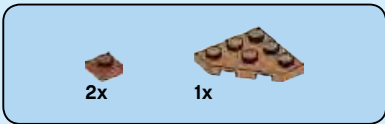

29

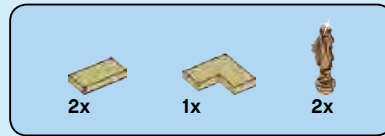

30



31



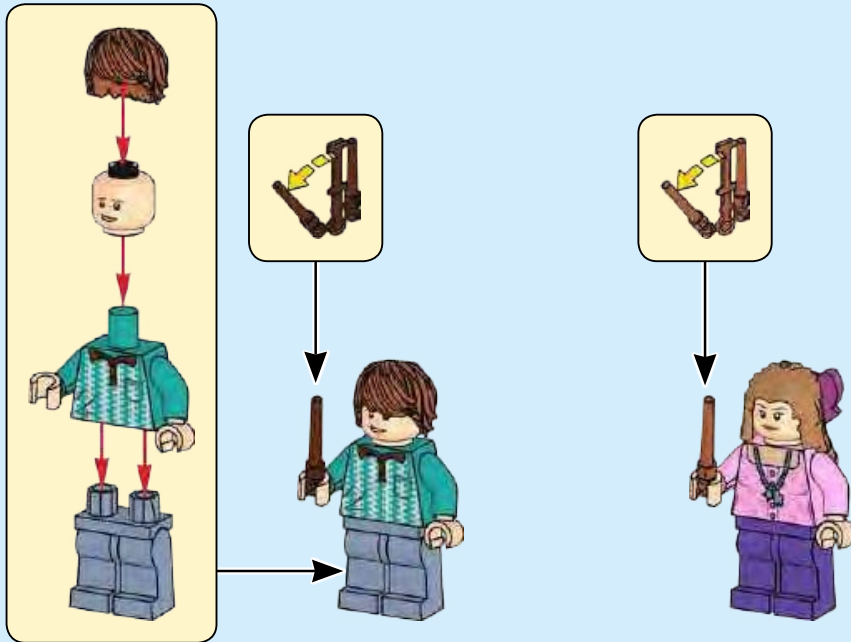
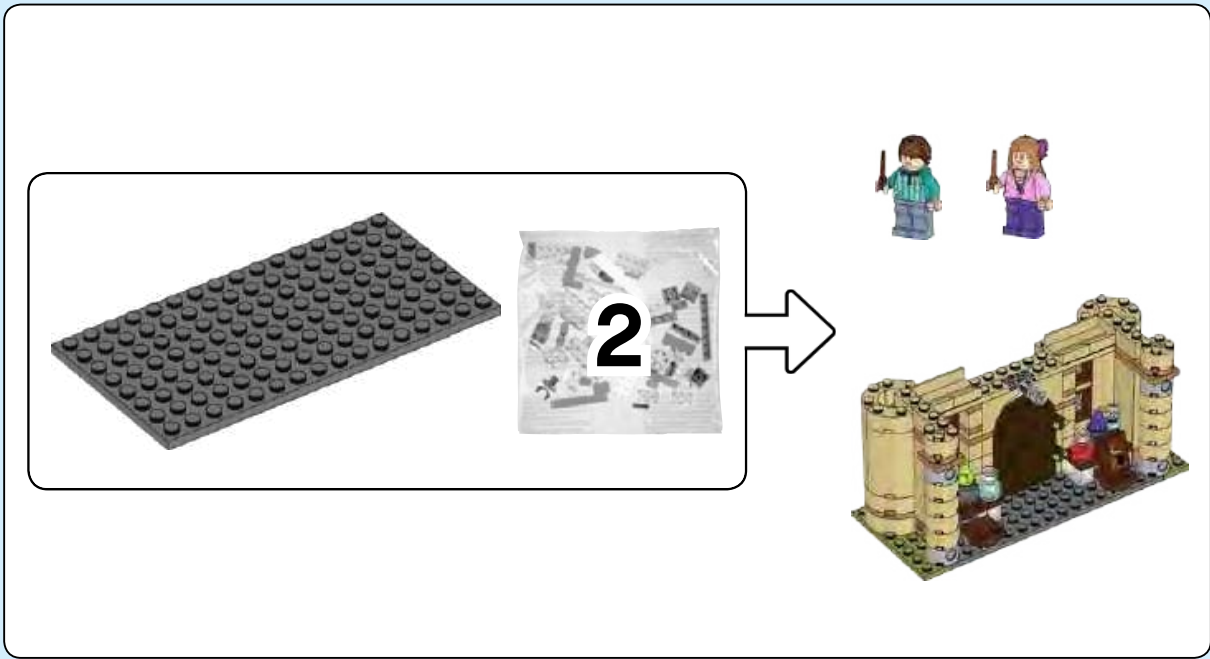

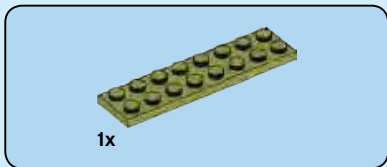

1

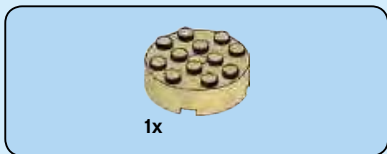
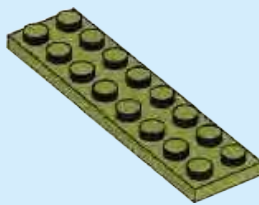

2

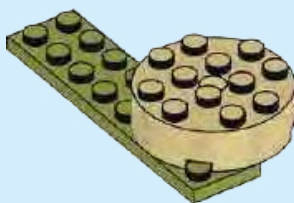

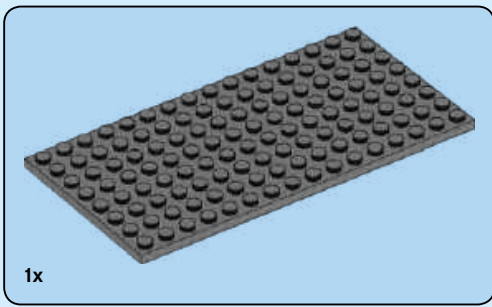

3

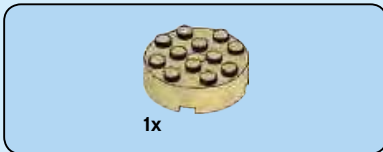
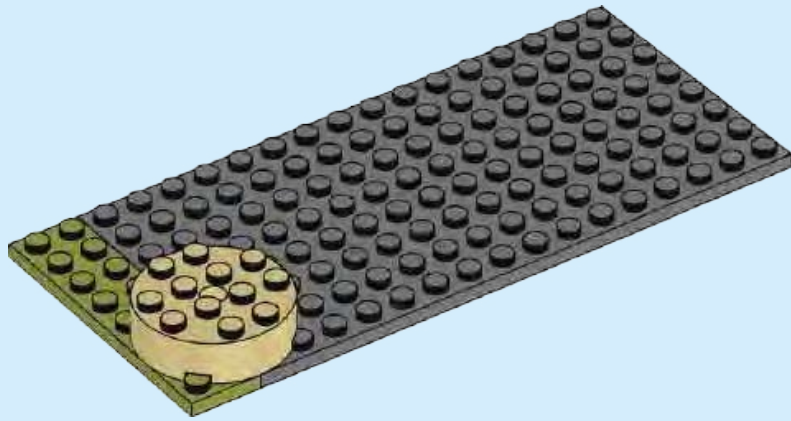

4

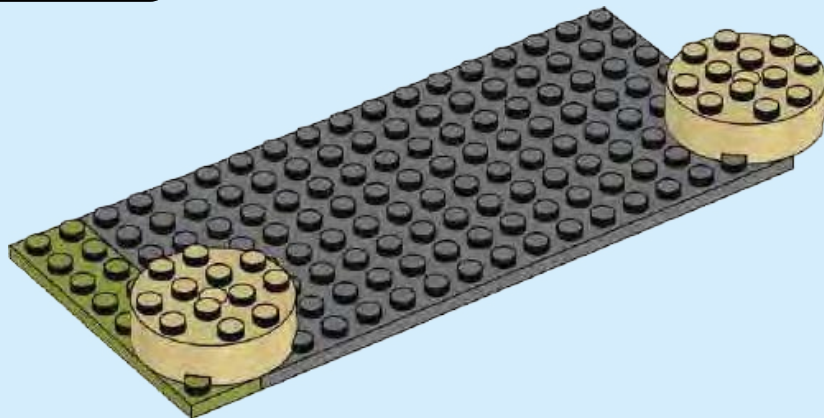



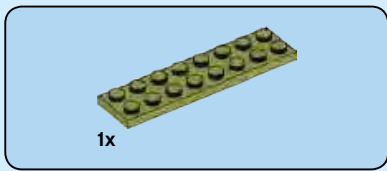

5

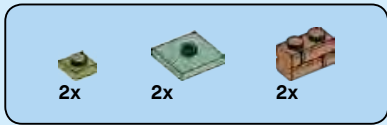
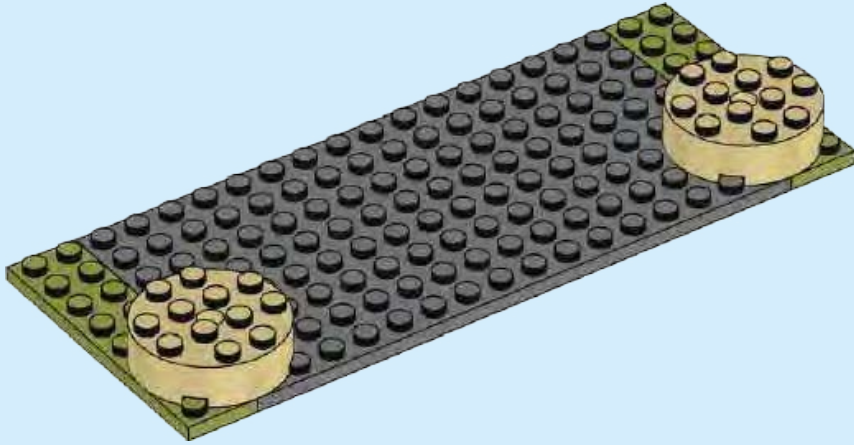

6

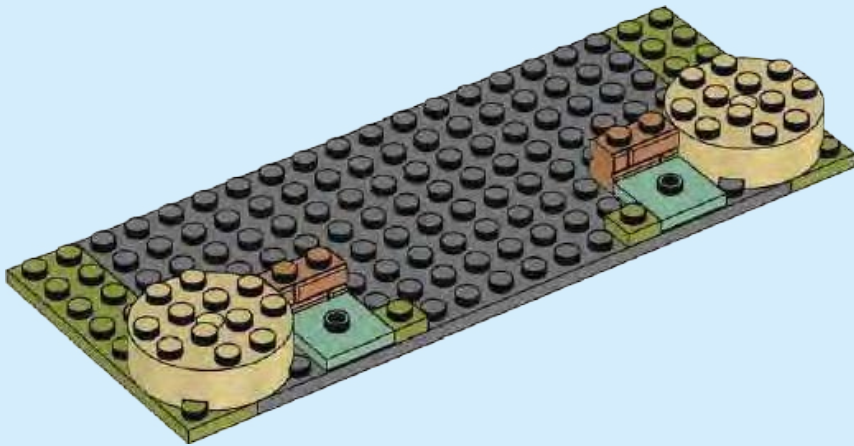

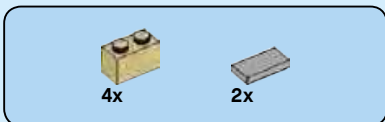

7

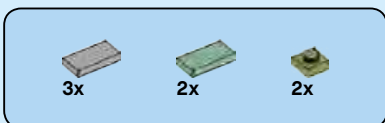
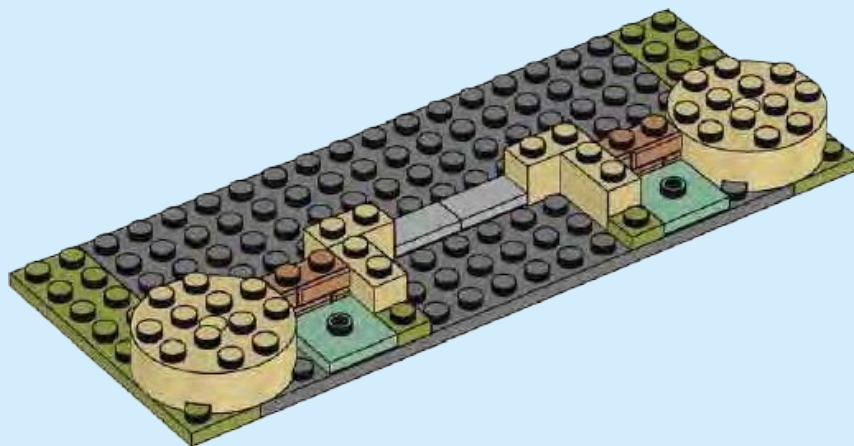

8

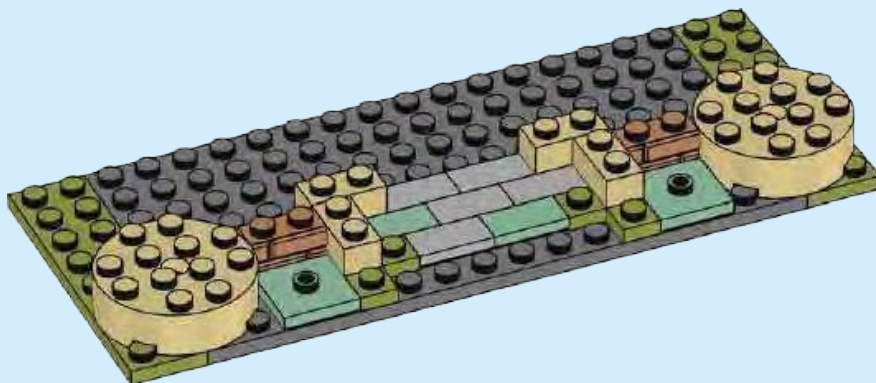

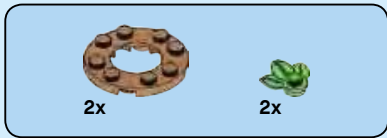

9

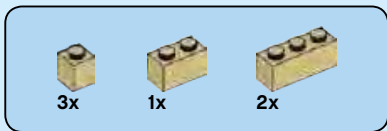

10



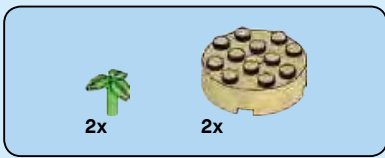

11



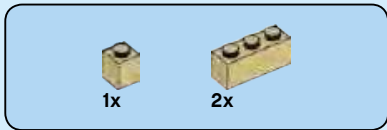

12

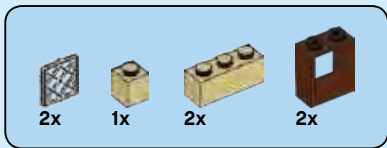

13

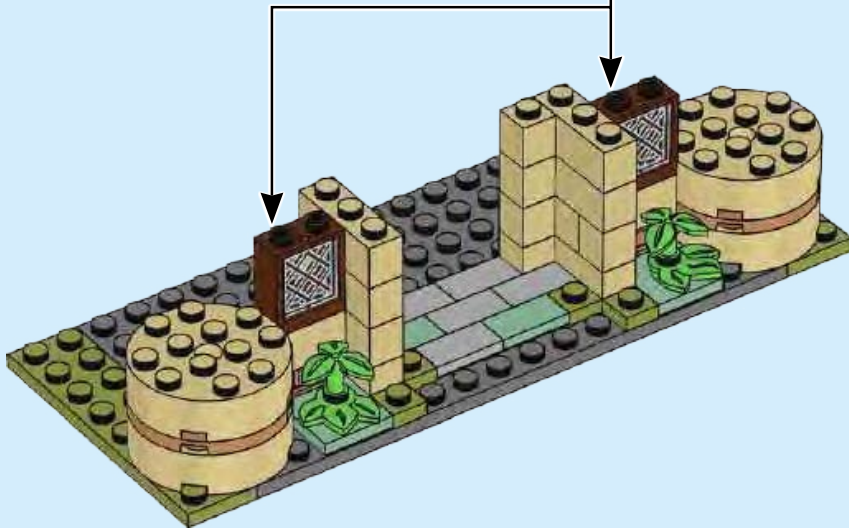
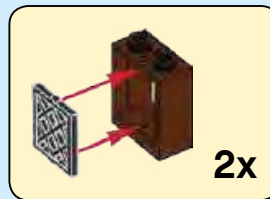



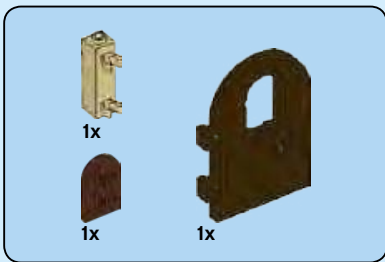

14

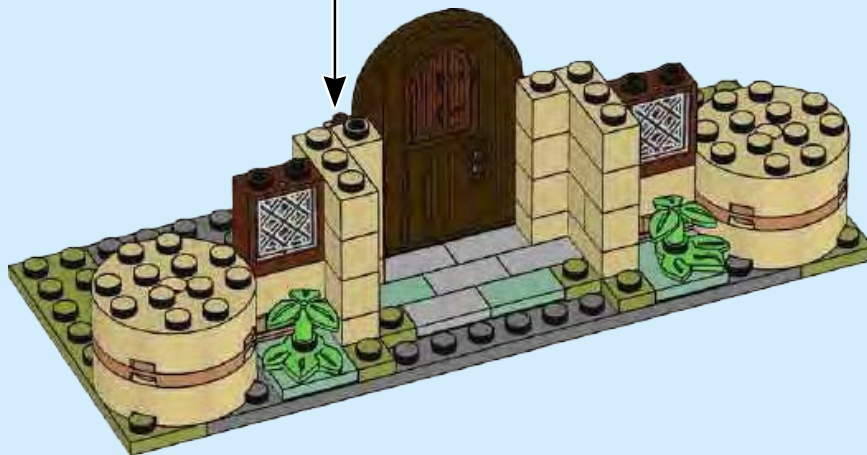
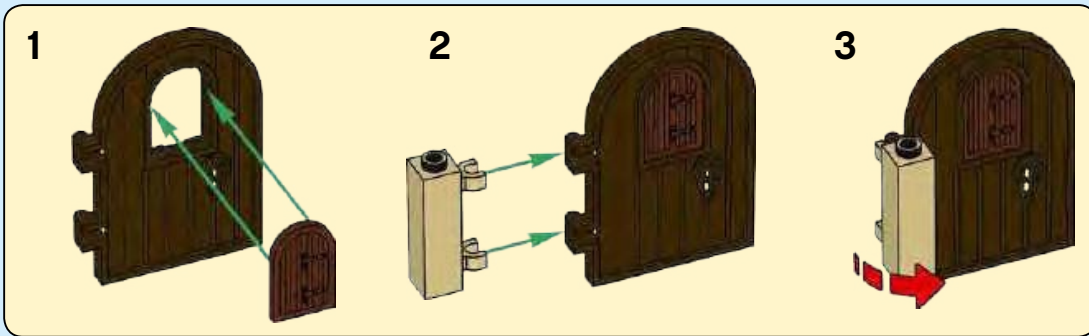

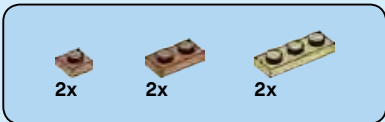

15

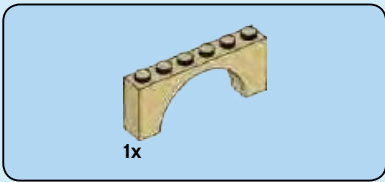

16



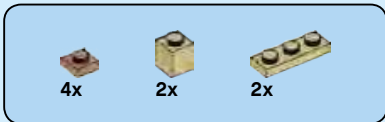

17

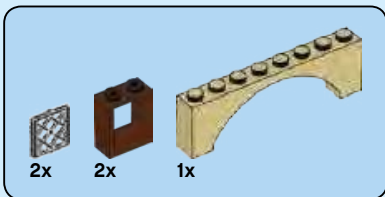
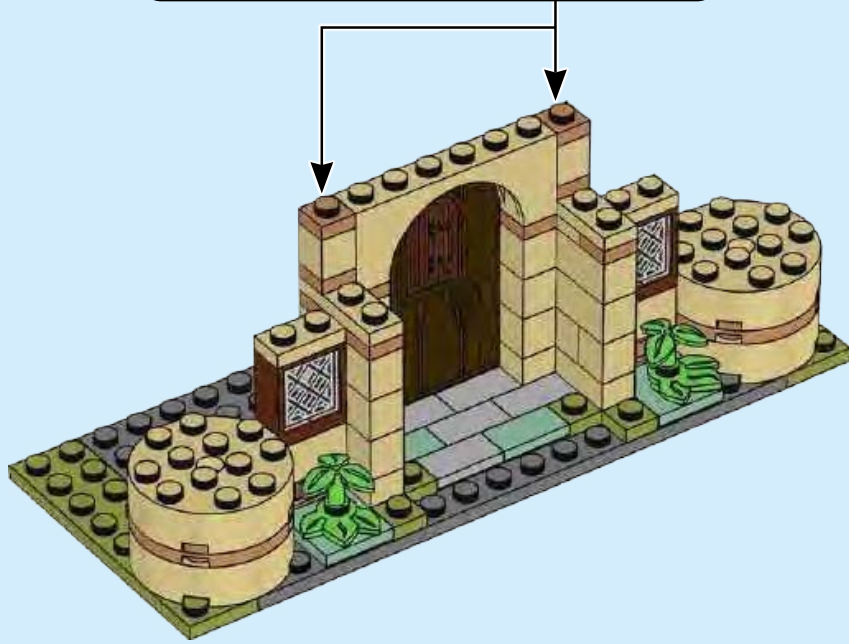
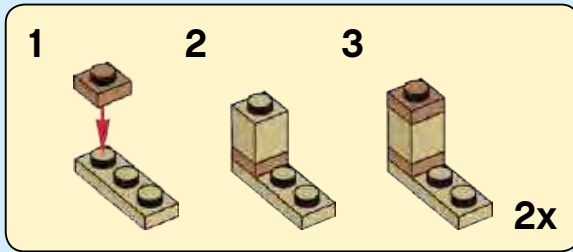

18

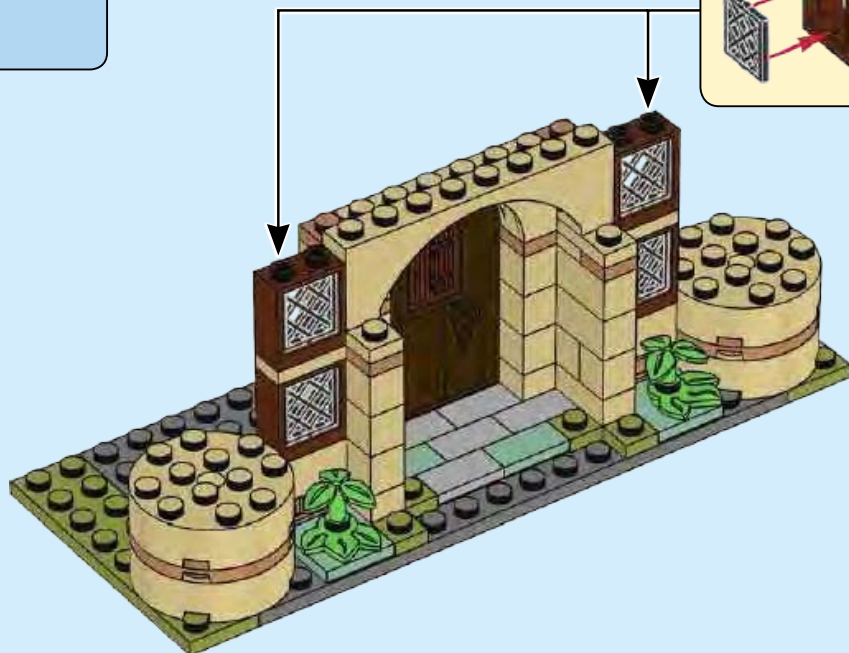
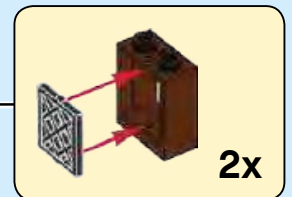

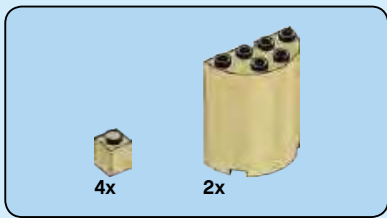

19

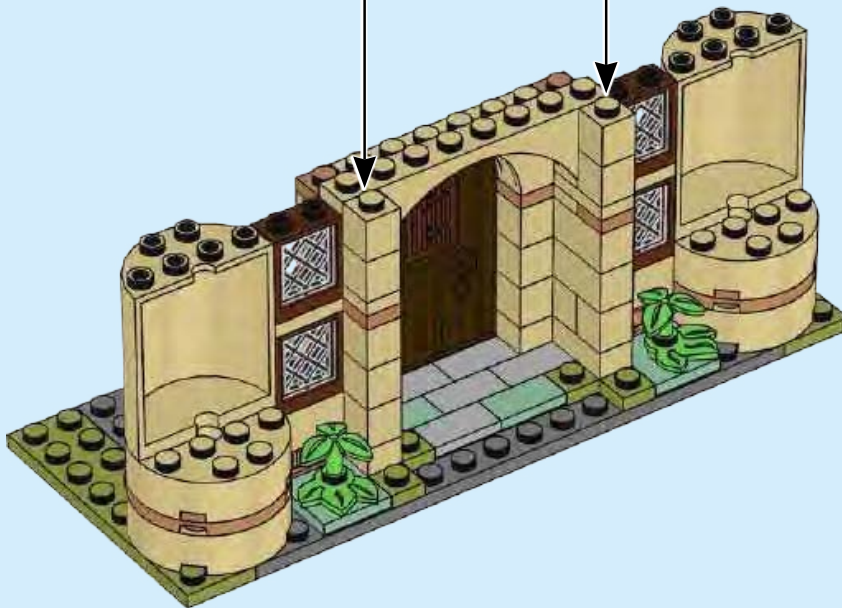
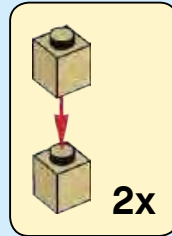

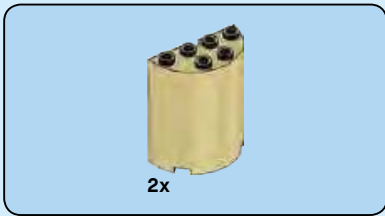

20

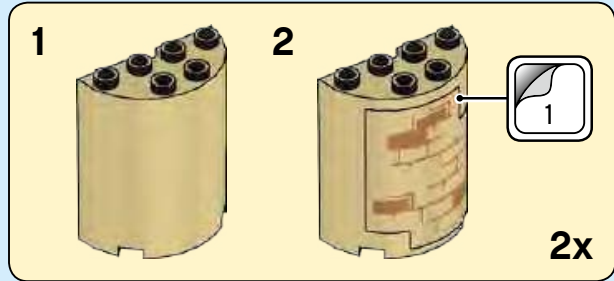





2x

# 21



2x



2x

# 22

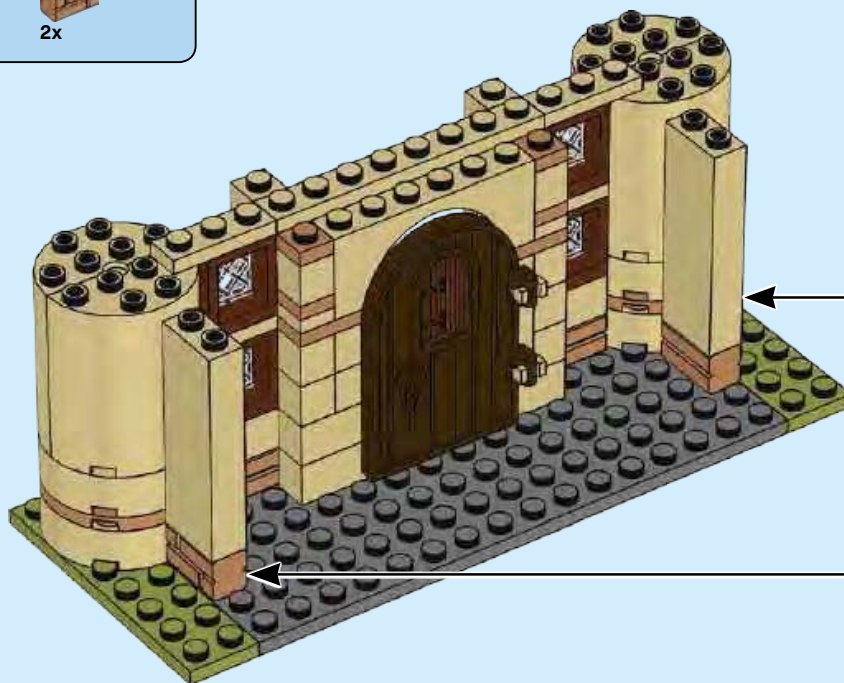

2x

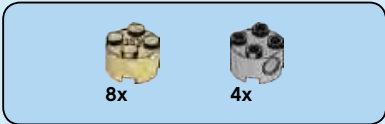

# 23

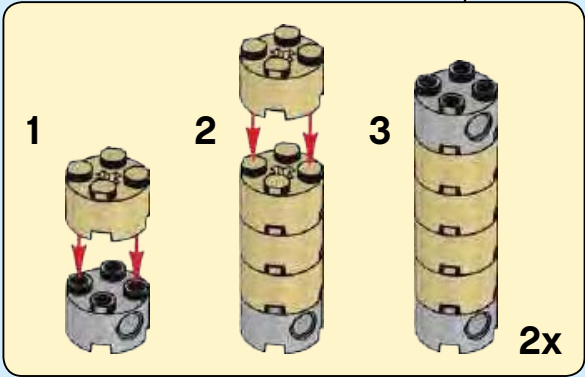



24

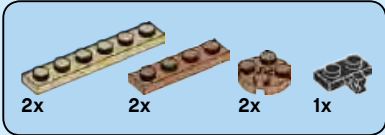
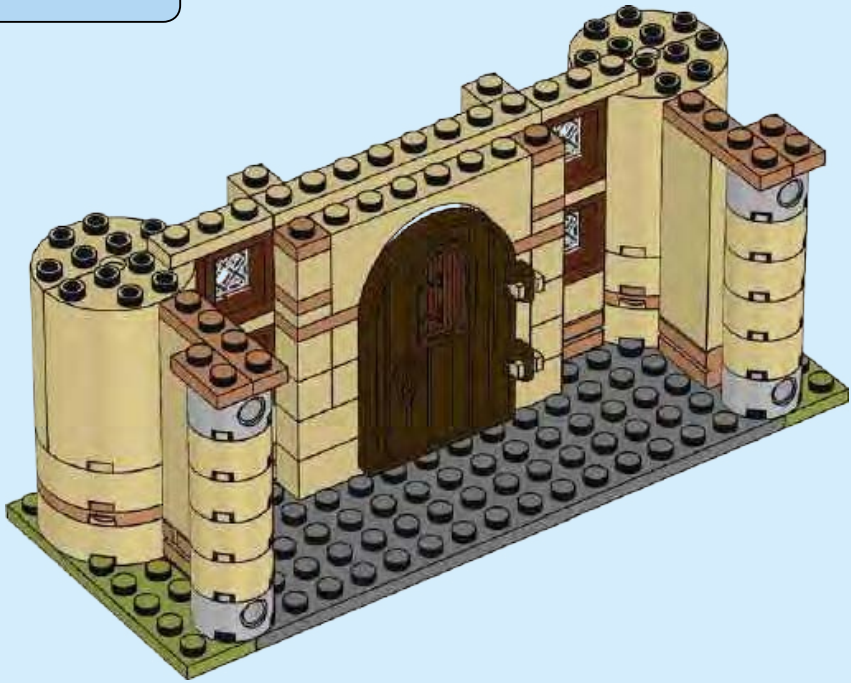

25

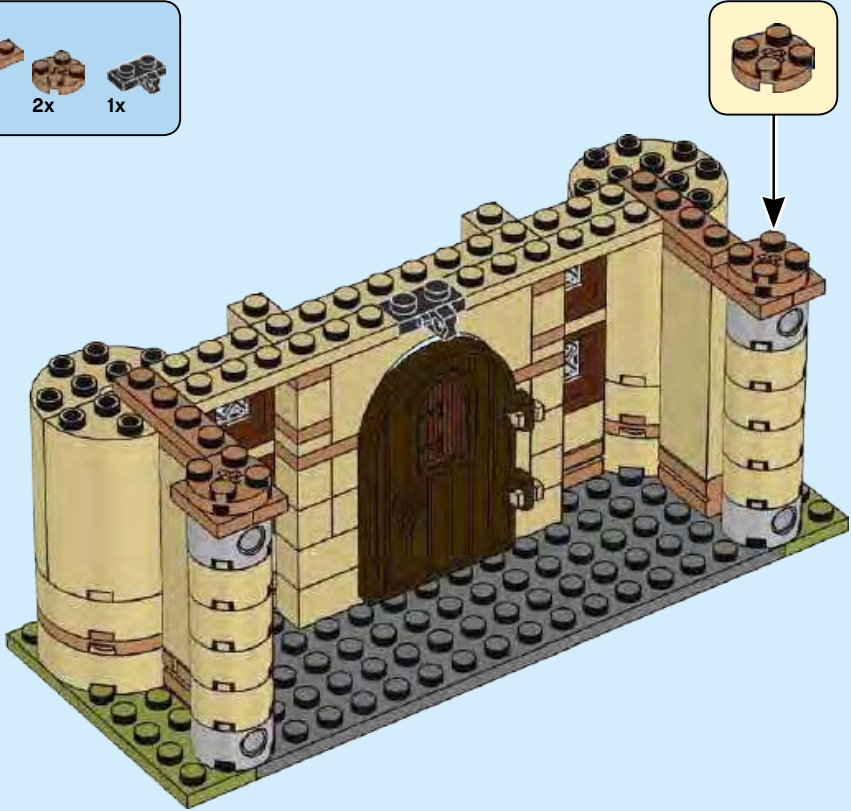



26







4x



1x

27





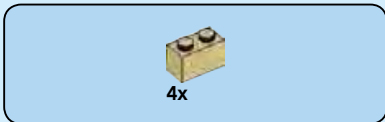

28

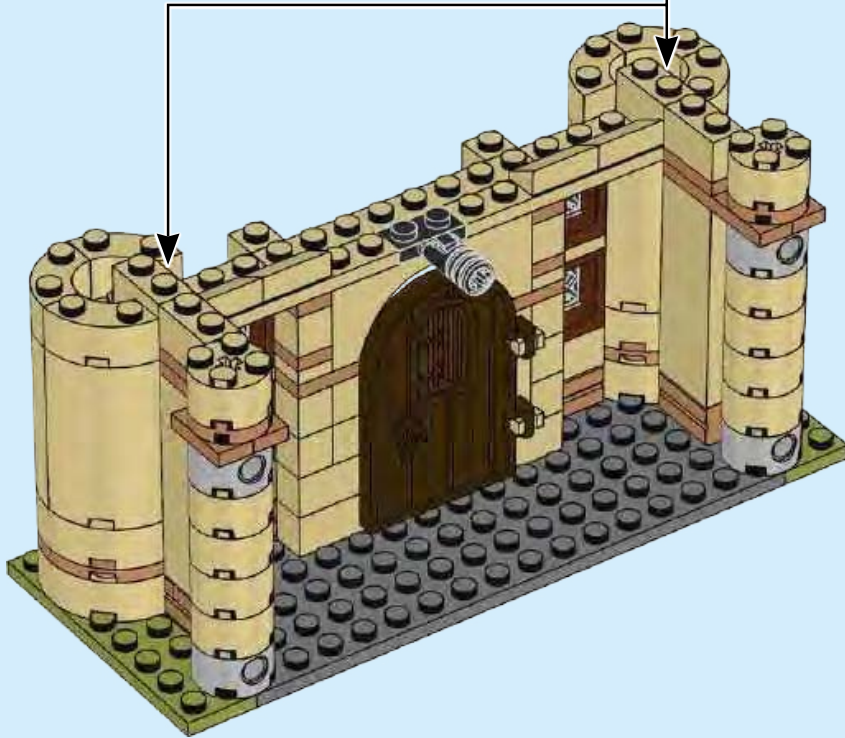
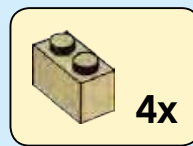

29

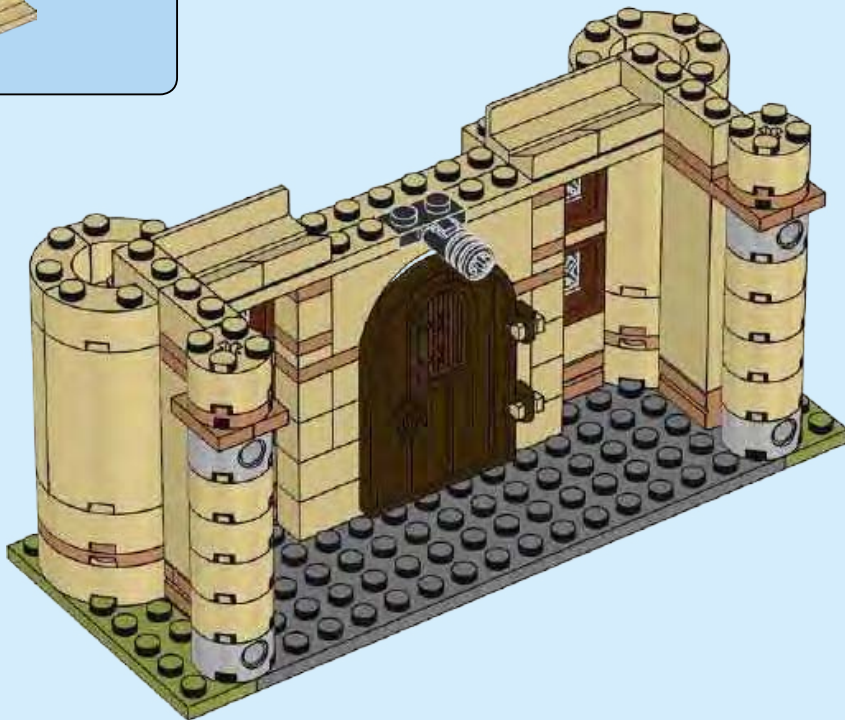



30



31

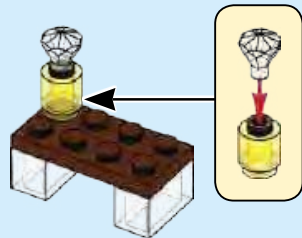

32

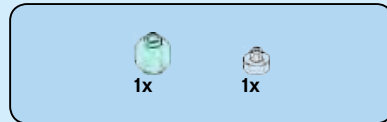
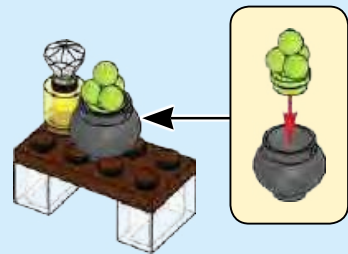

33



34

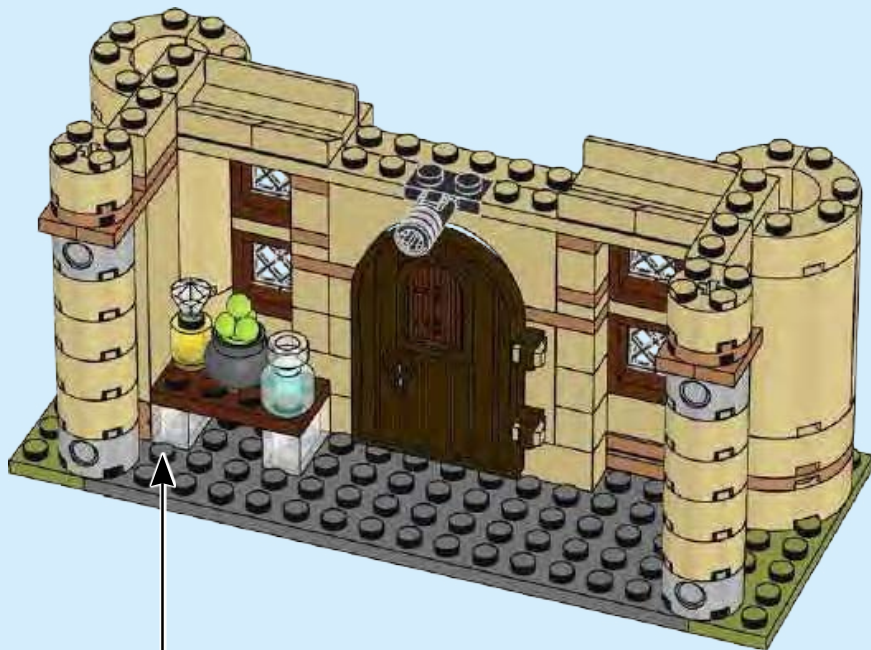



35

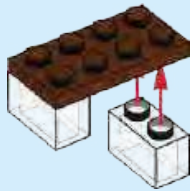

36

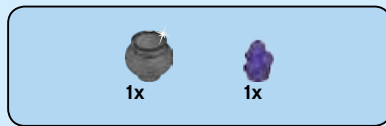
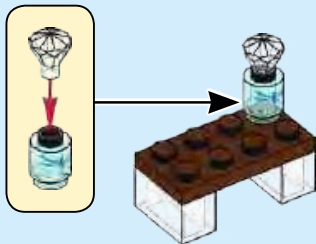

37

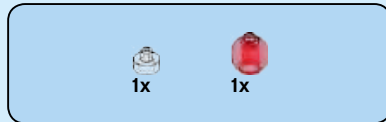
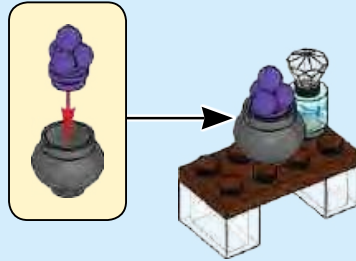

38

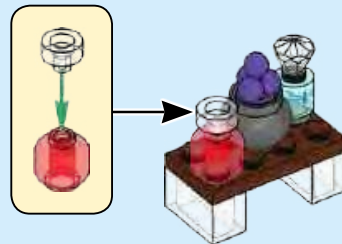

39







2x



2x

# 40

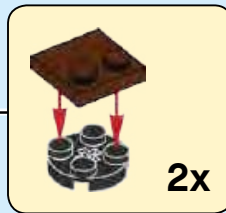
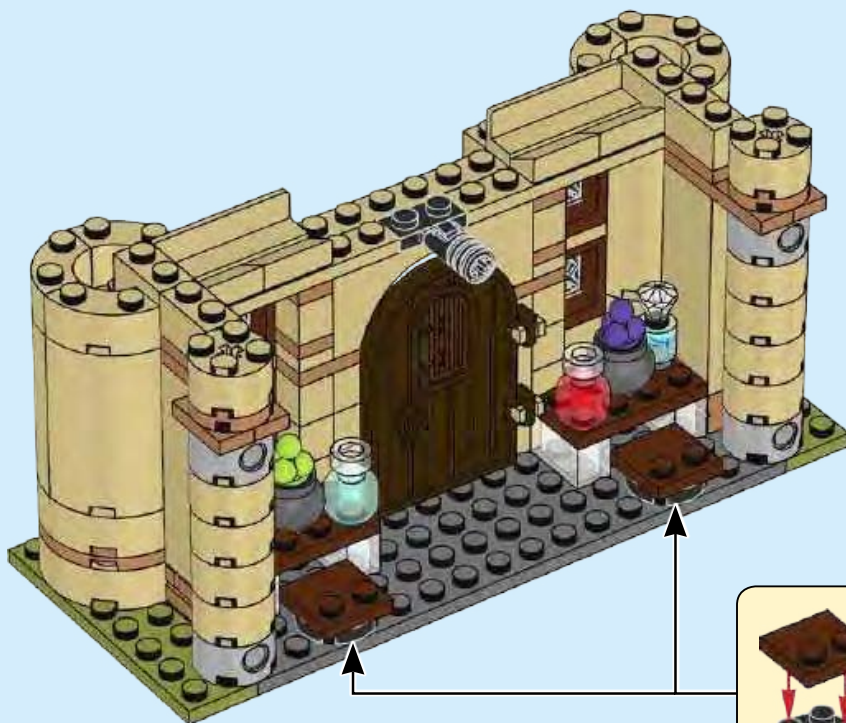

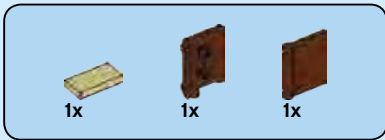

# 41

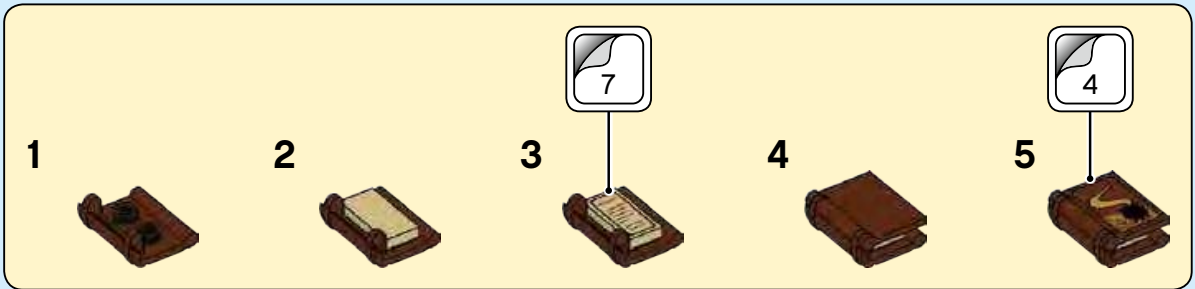

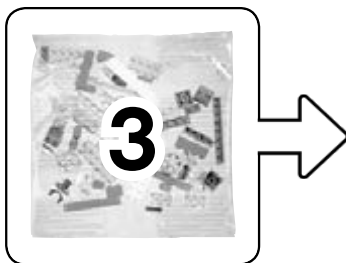

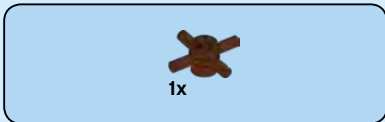

42

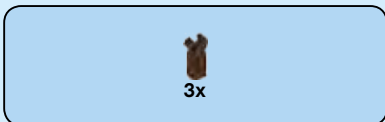

43

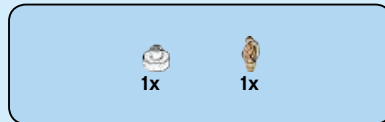

44

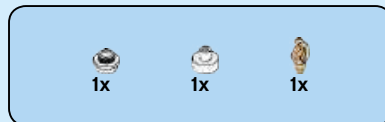

45

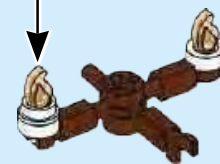



1x



1x

# 46

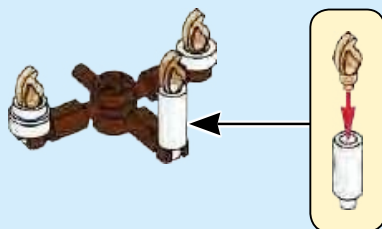

# 47

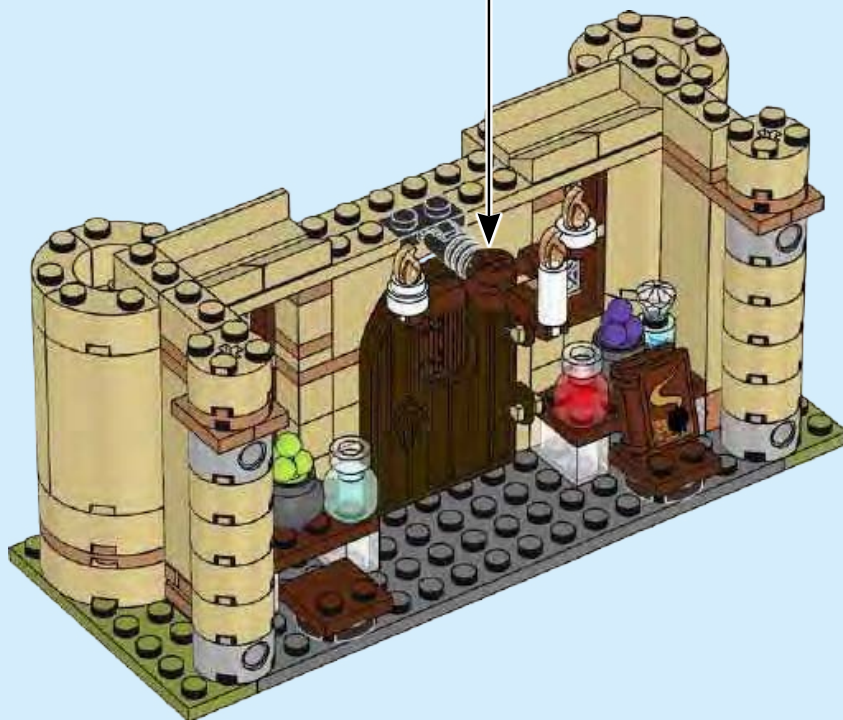

48



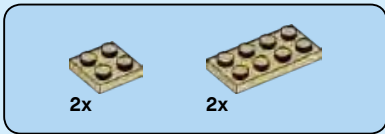

48



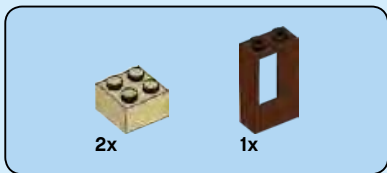

49

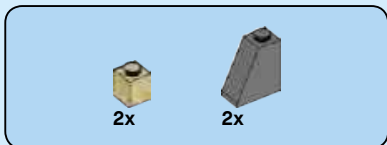

50



50

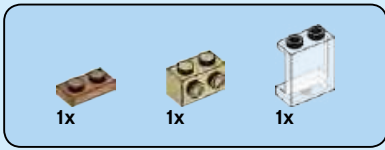

51





52



52



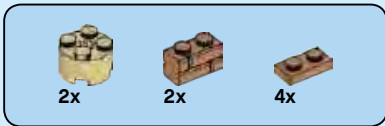

53

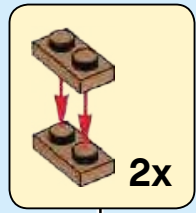

54







2x

55



54

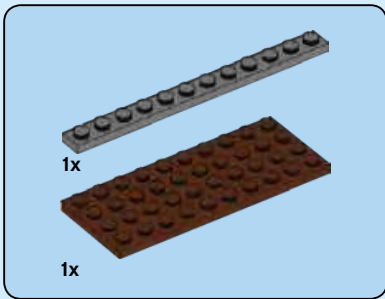
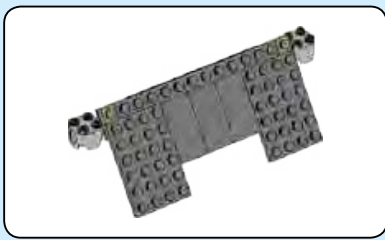

56

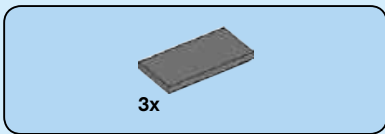
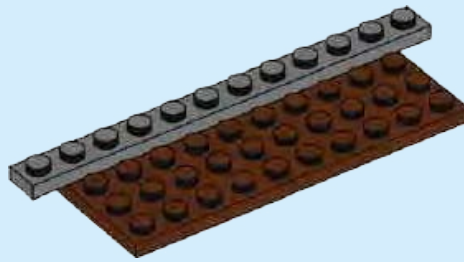

57

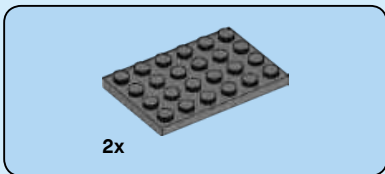
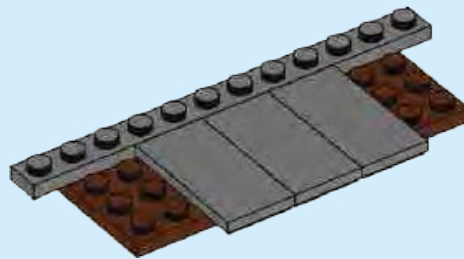

58

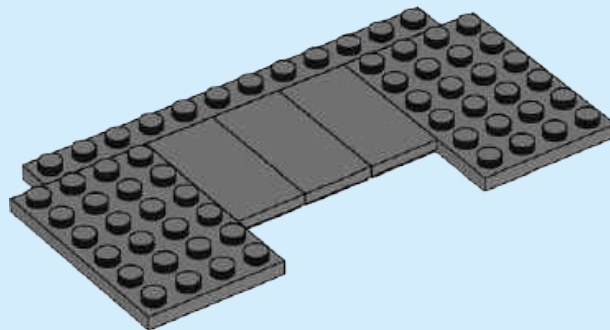



2x

# 59

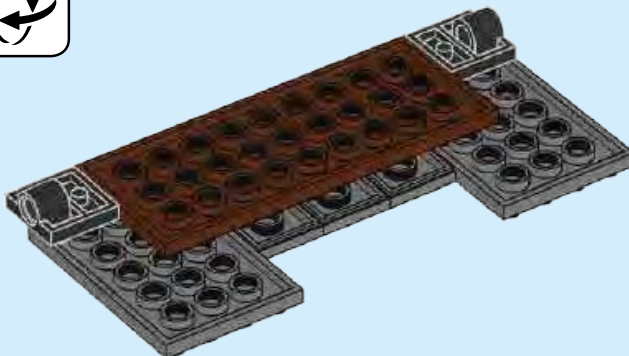

2x



2x

# 60

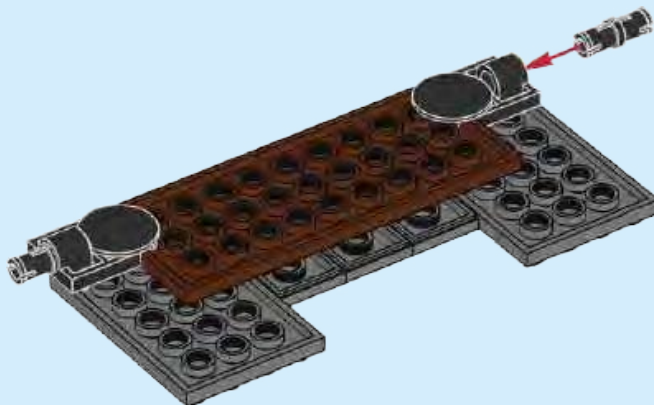

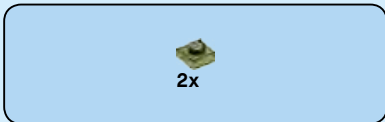

61

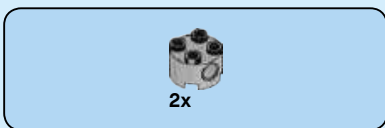
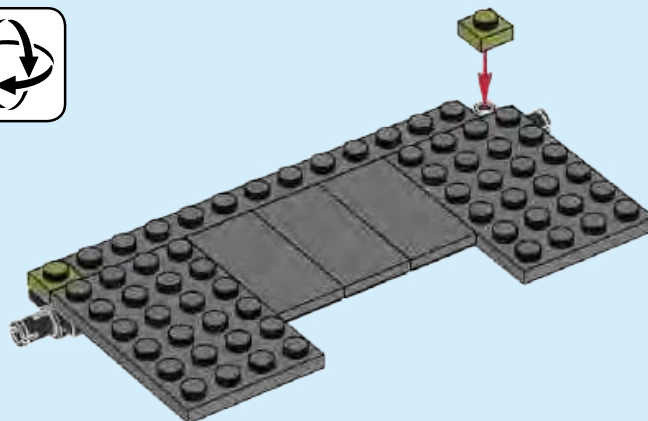

62

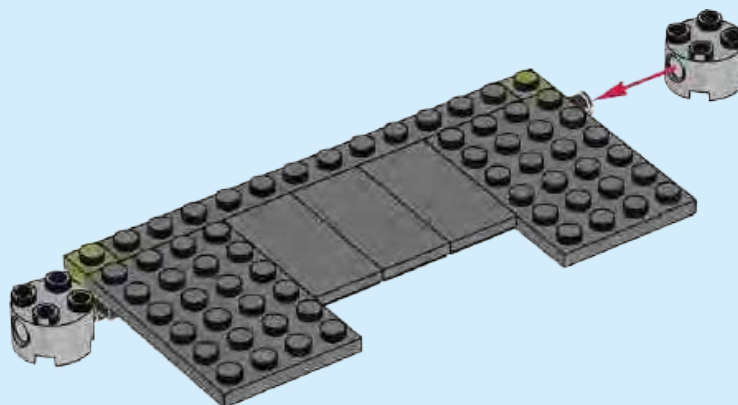

63

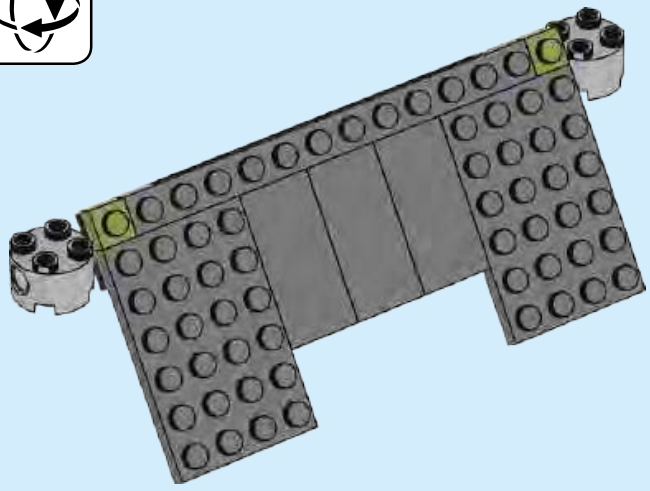

64





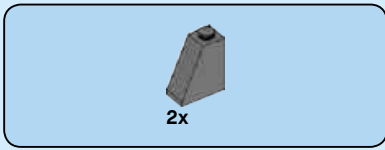

65





2x



1x

66



60

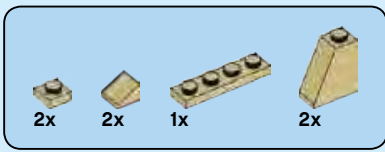

67

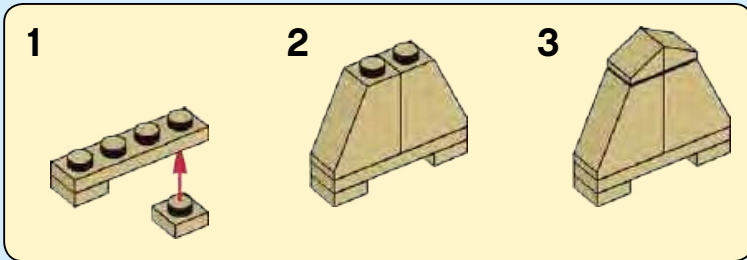

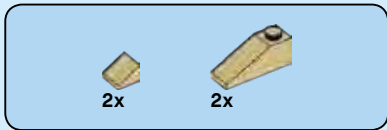

68

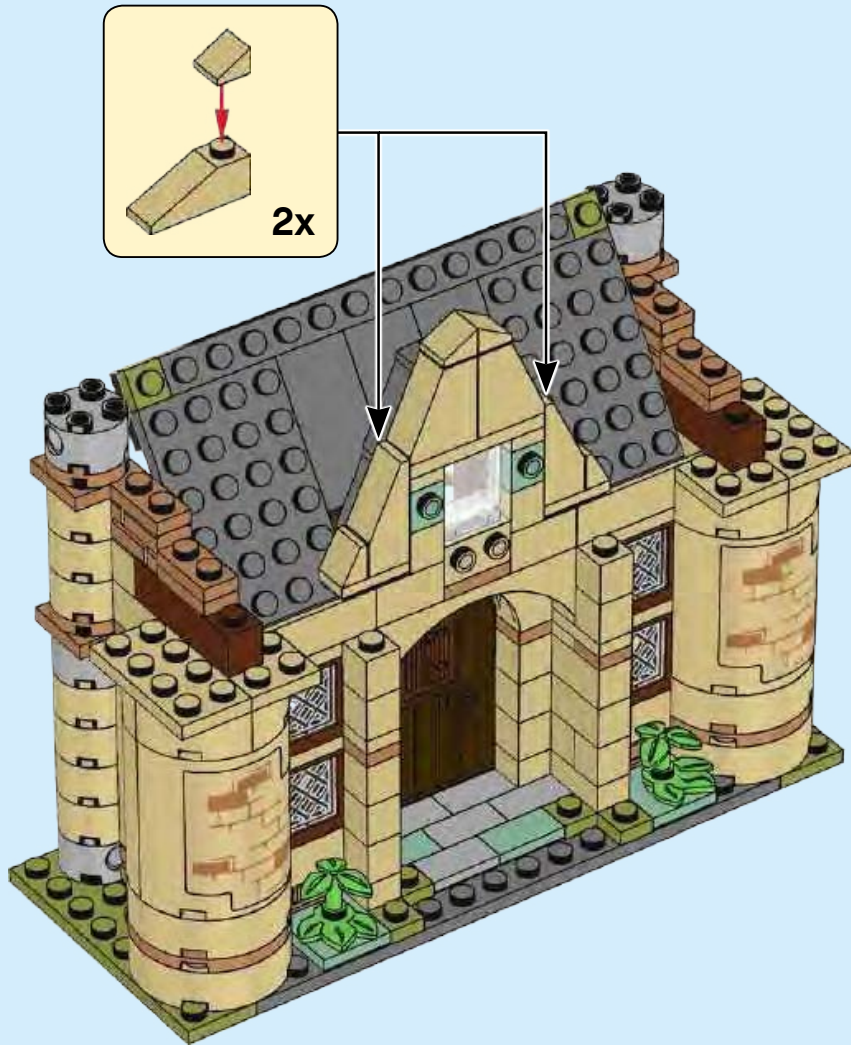





2x



4x

69







8x

70



64

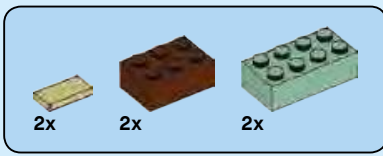

71



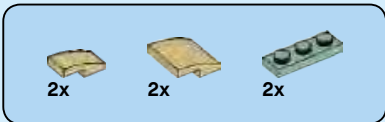

72

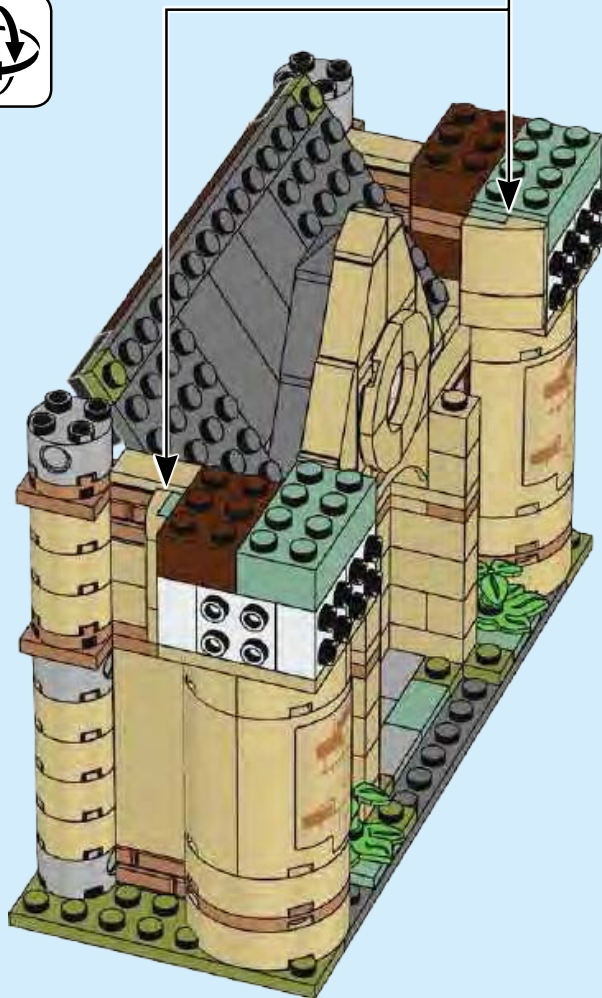
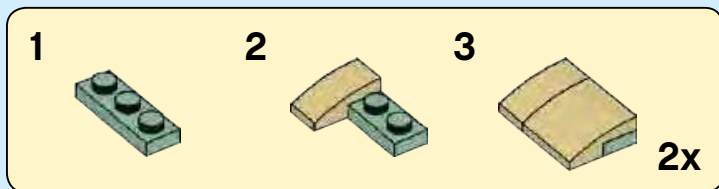

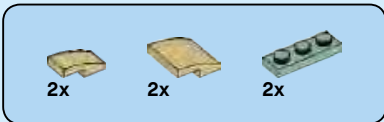

73

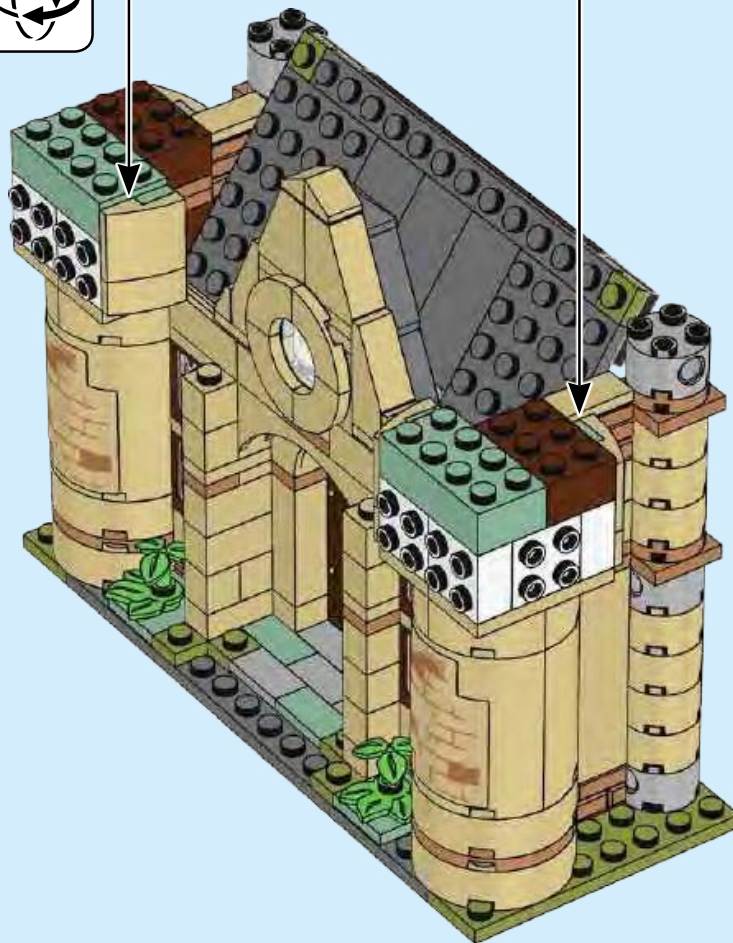



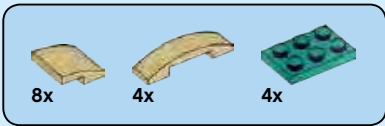

74

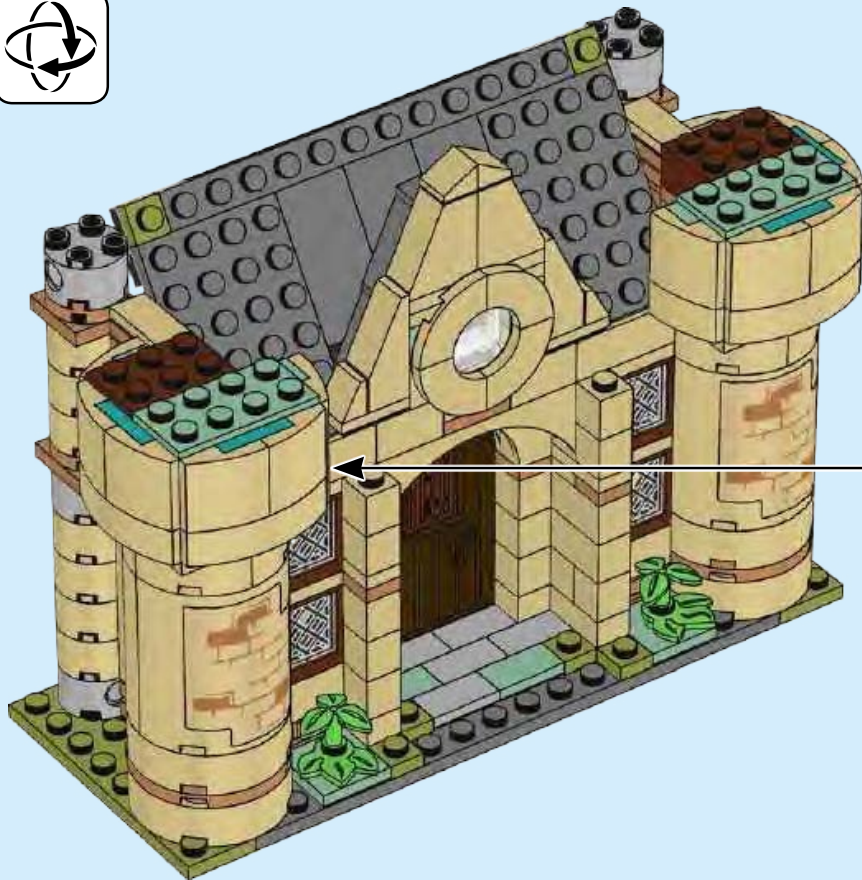
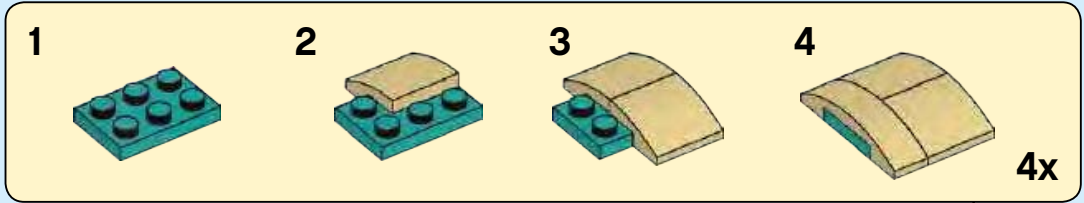





75

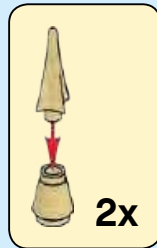



76

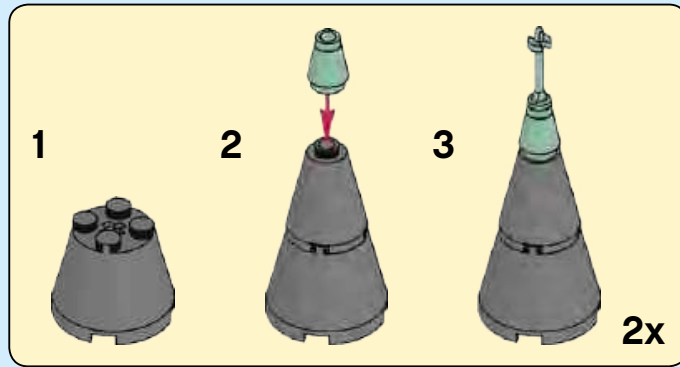

70



77

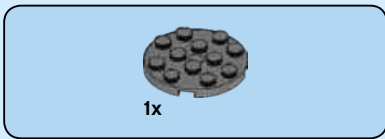

78

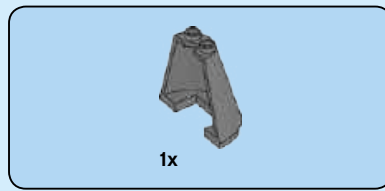

79

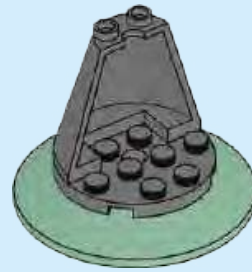

80

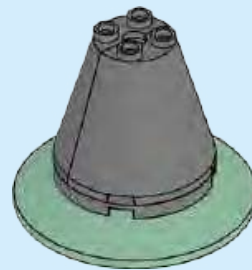



81

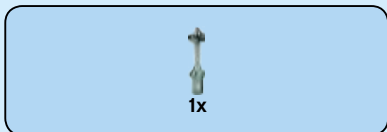
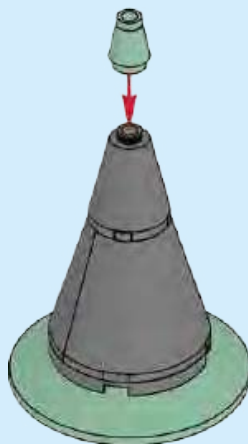

82

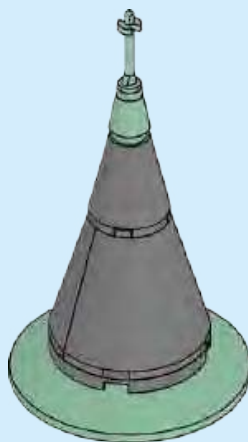

2x





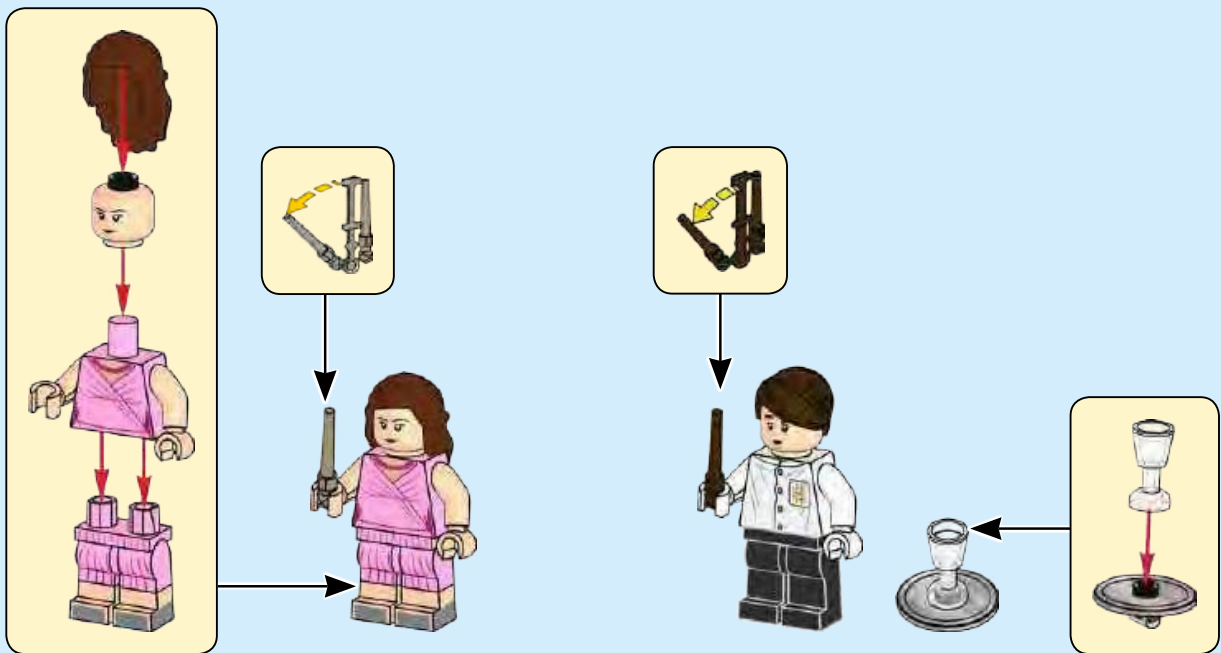
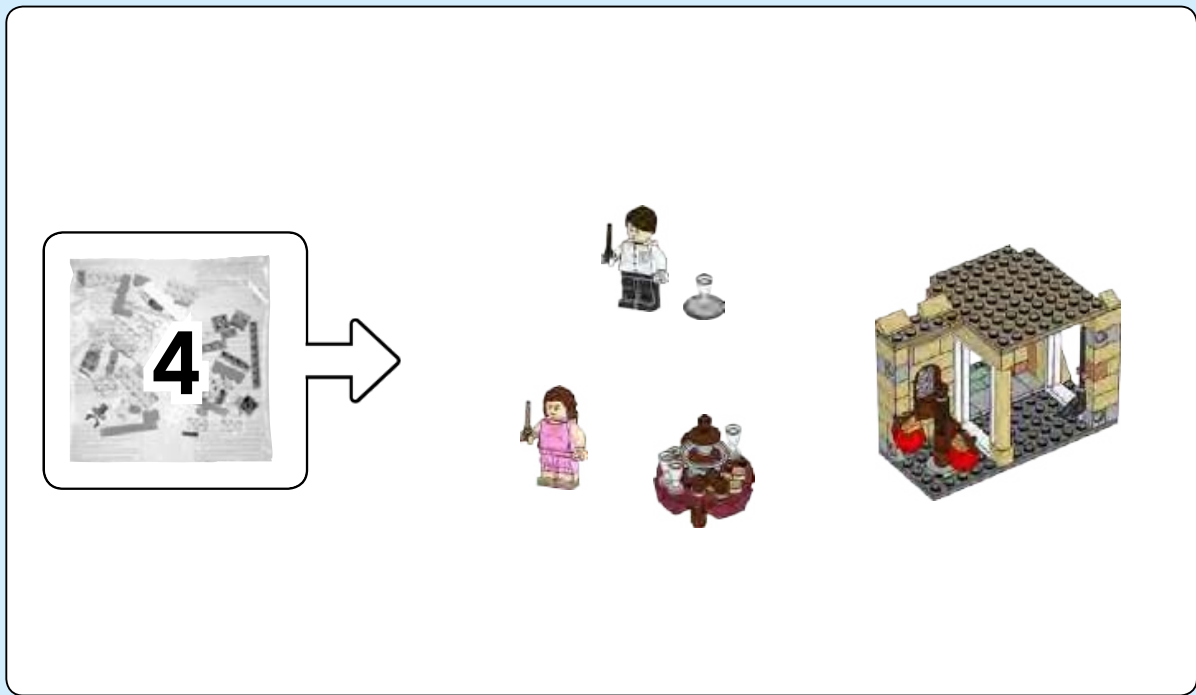

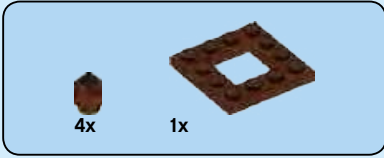

1

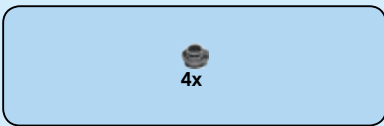
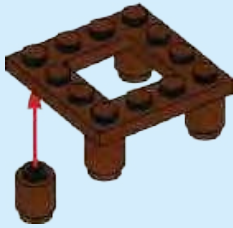

2



3



4



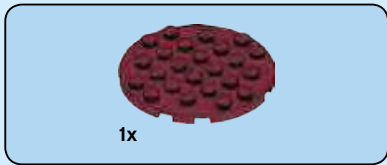

5

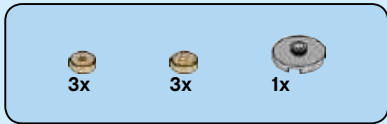

6

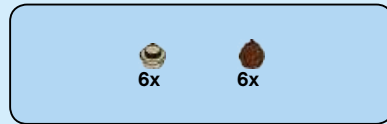

7

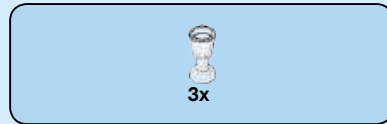
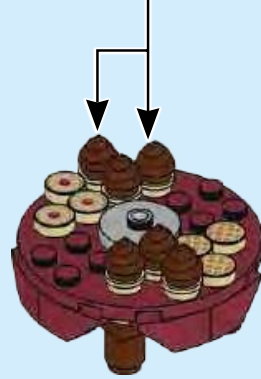
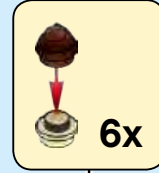

8



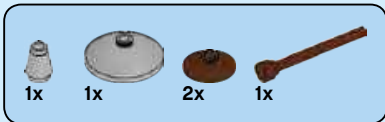

9

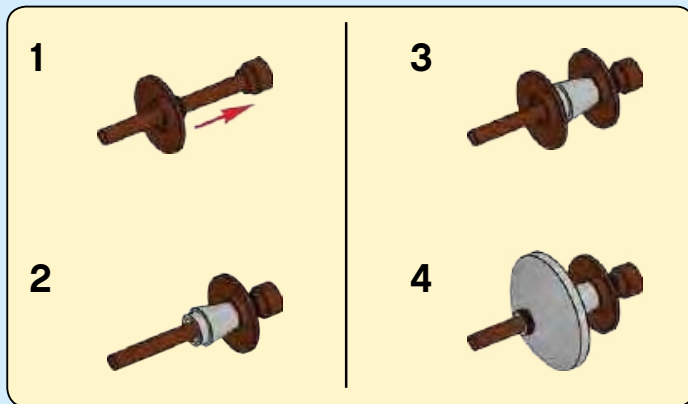

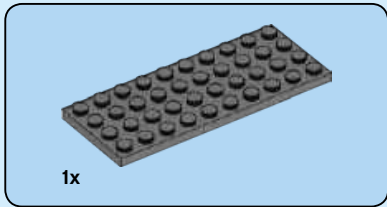

1x

1

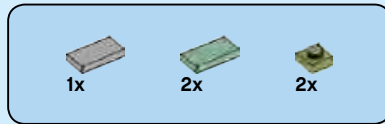
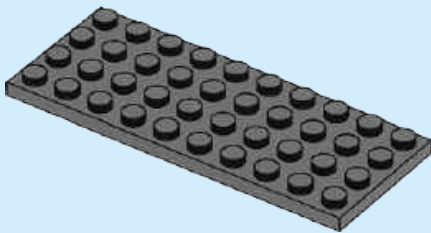

1x

2x

2x

2

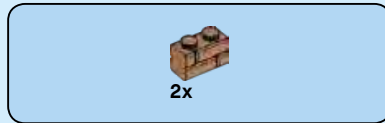
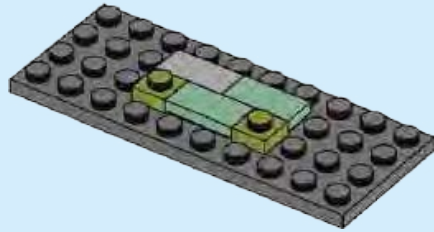

2x

3

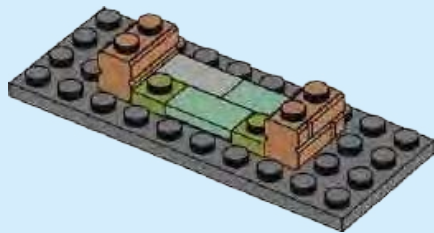



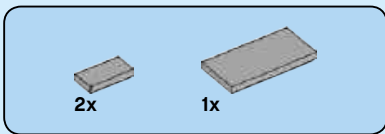

4

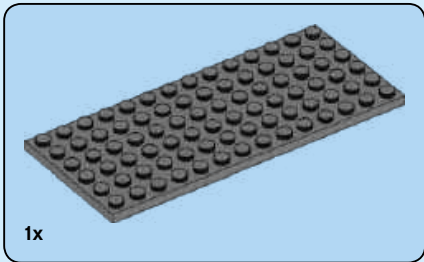
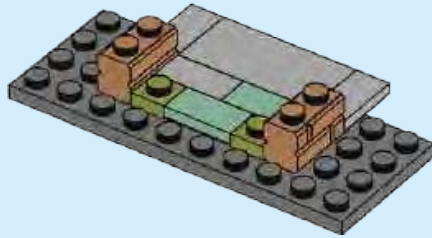

5

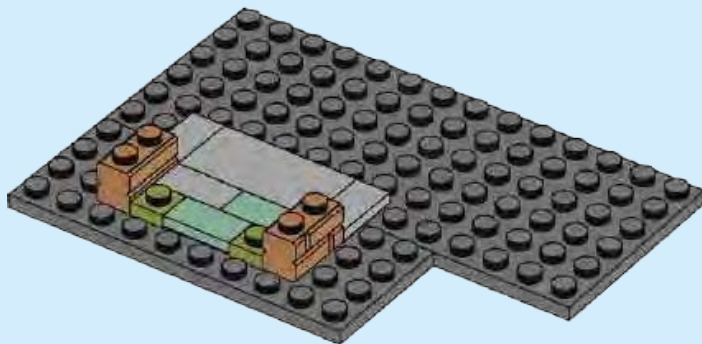

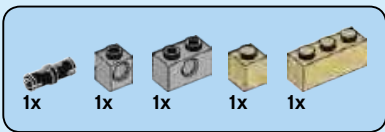

6

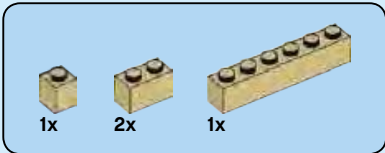
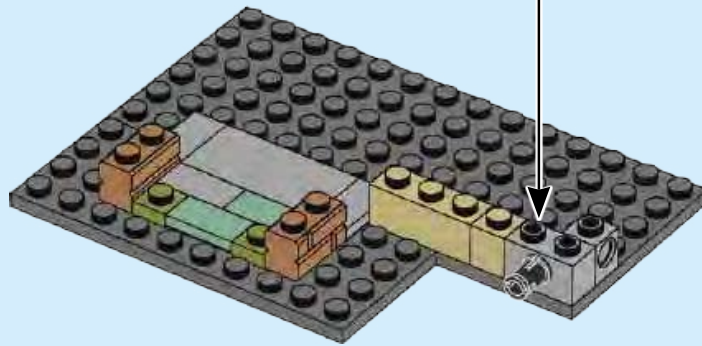
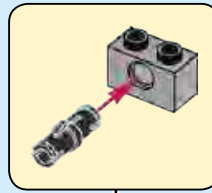

7

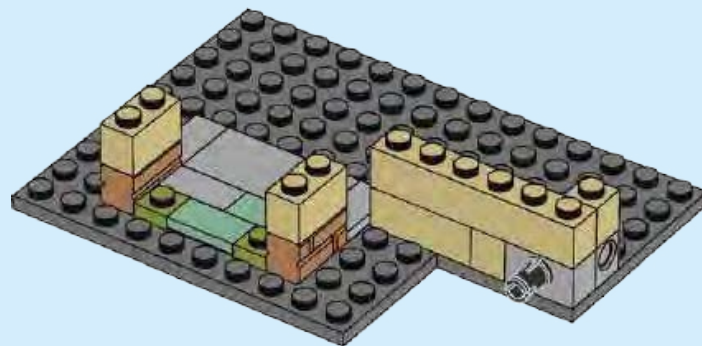

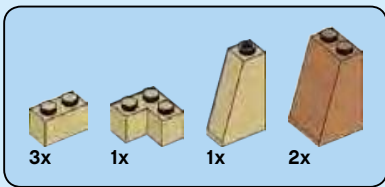

8

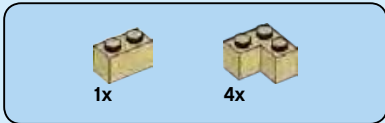
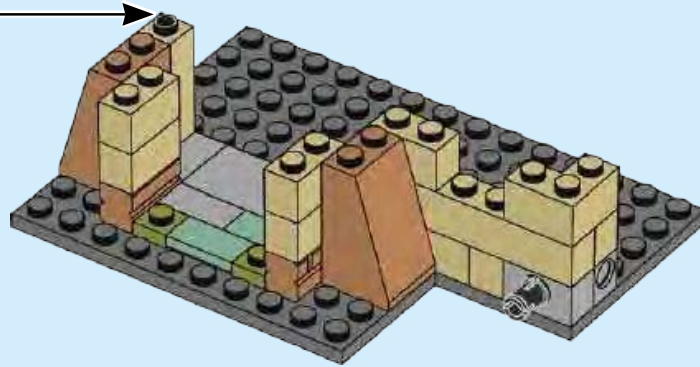

9

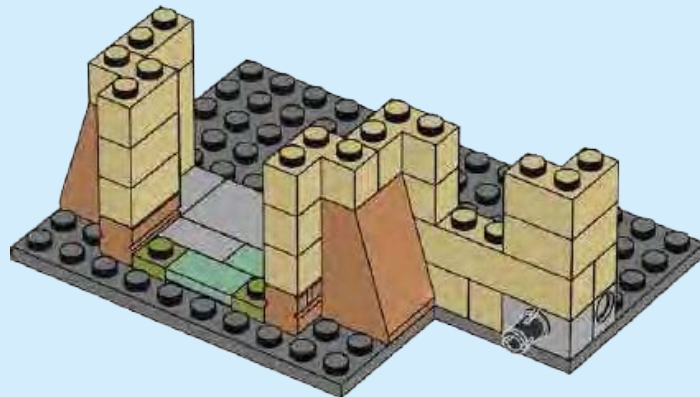

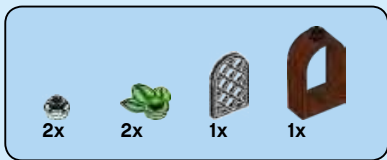

10

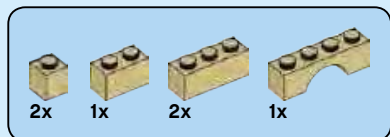
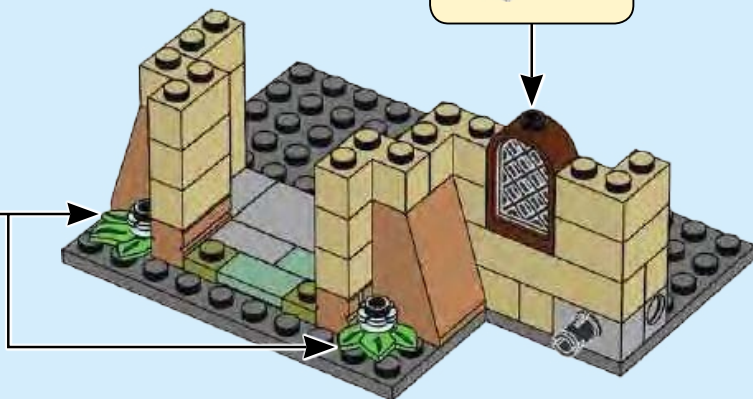

11

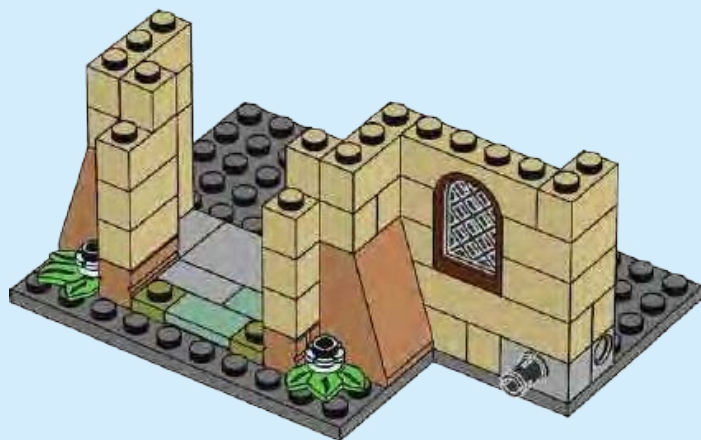

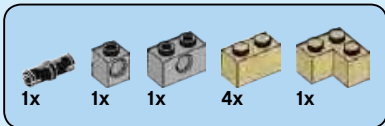

12

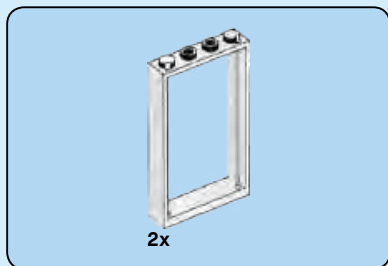
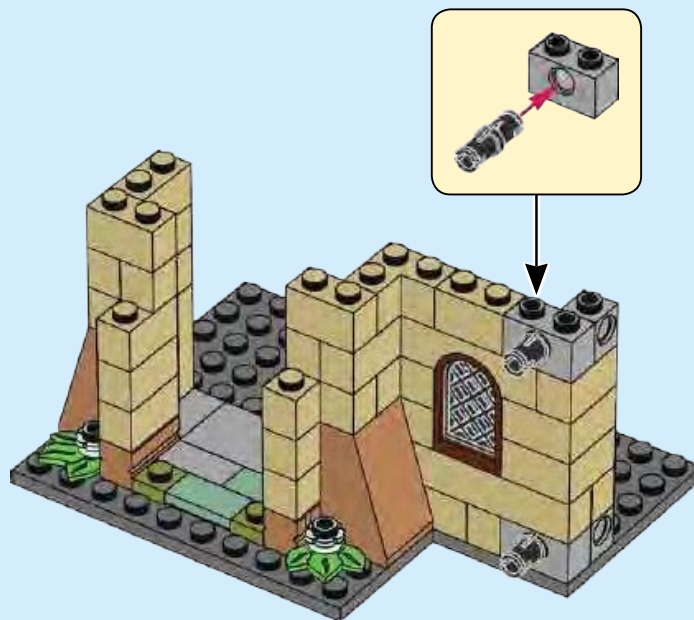

13

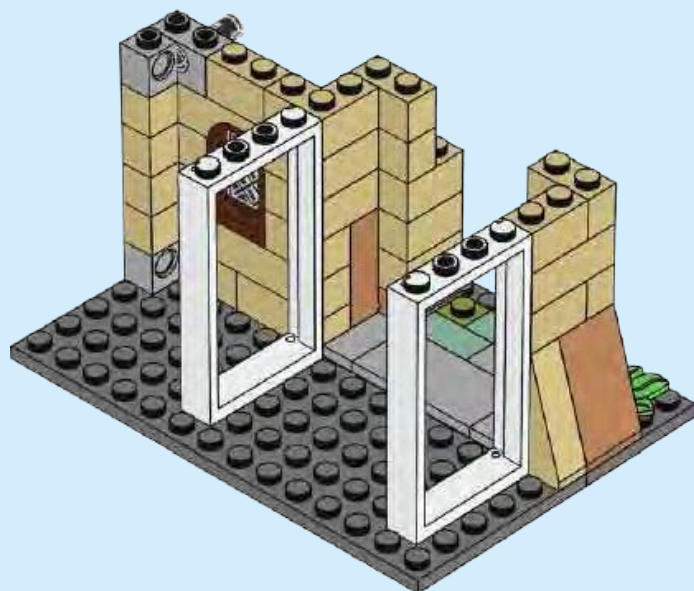



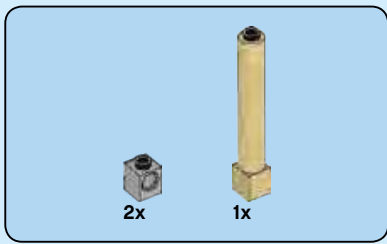

14

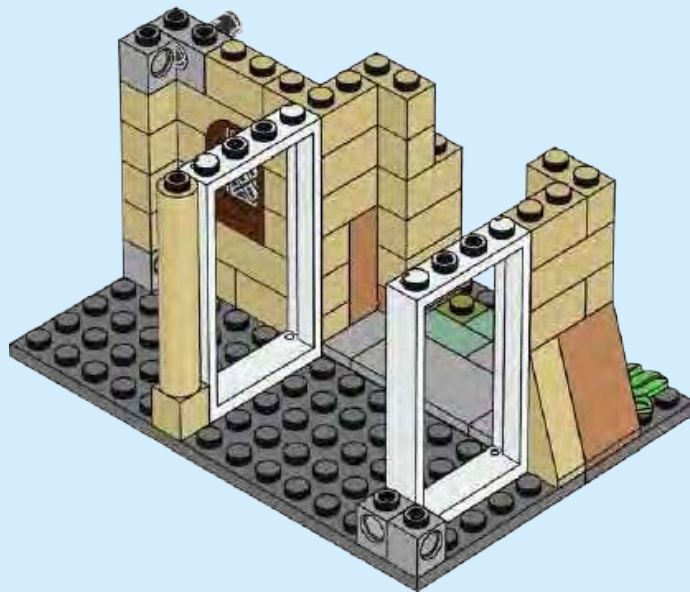



# 15

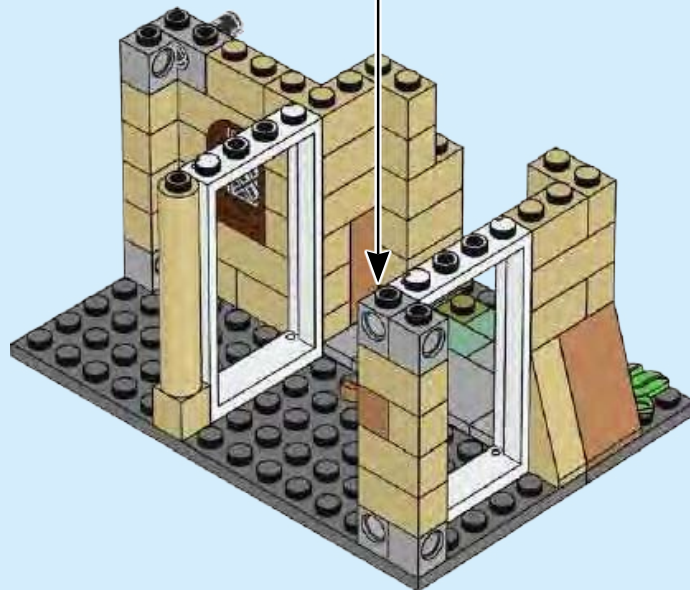
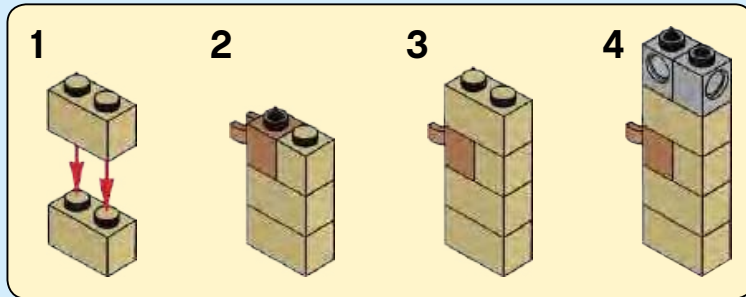

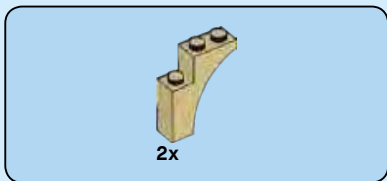

16

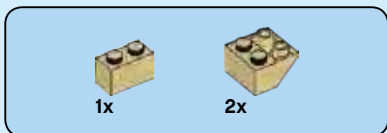
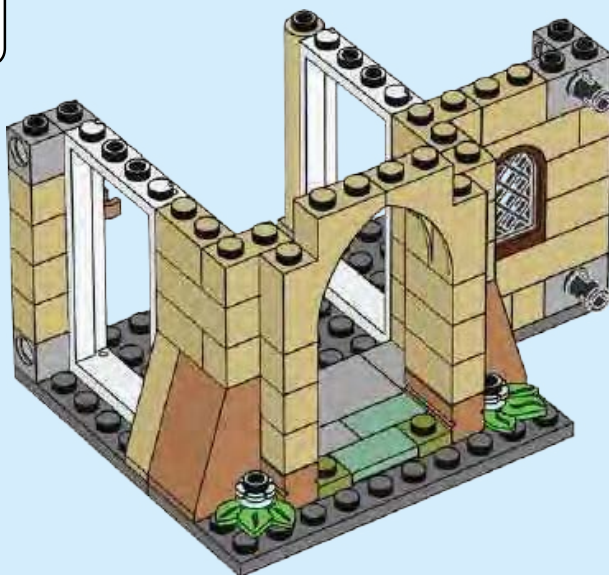

17

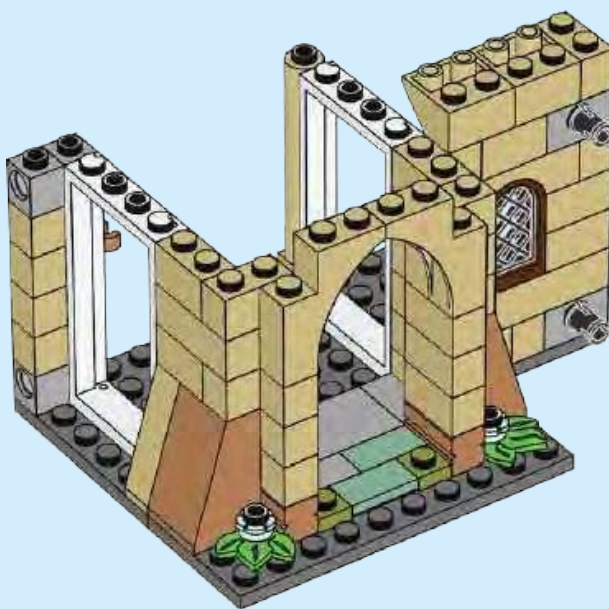

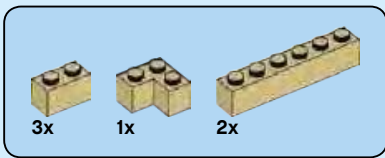

18

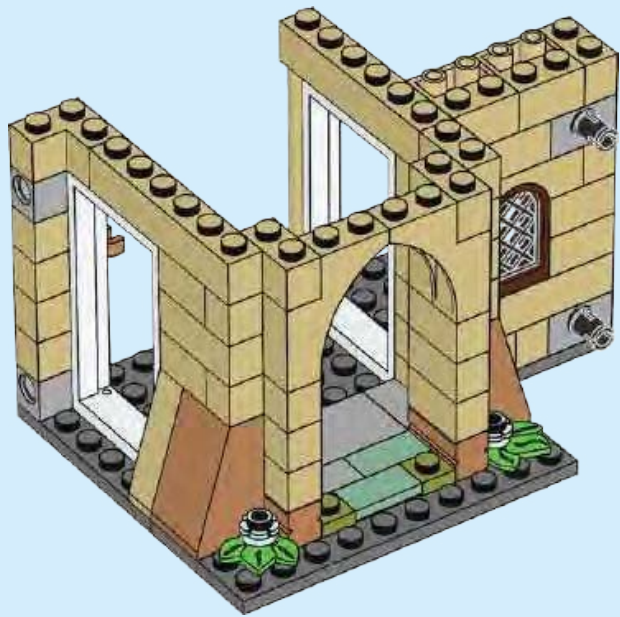

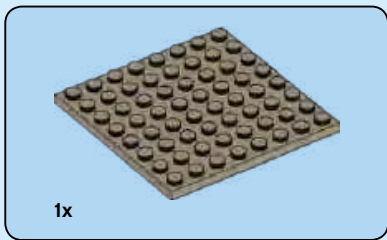

19

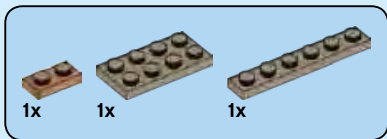
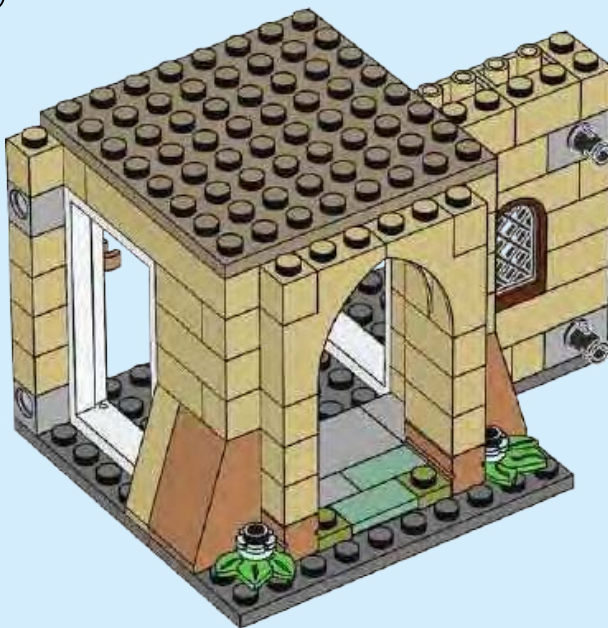

20

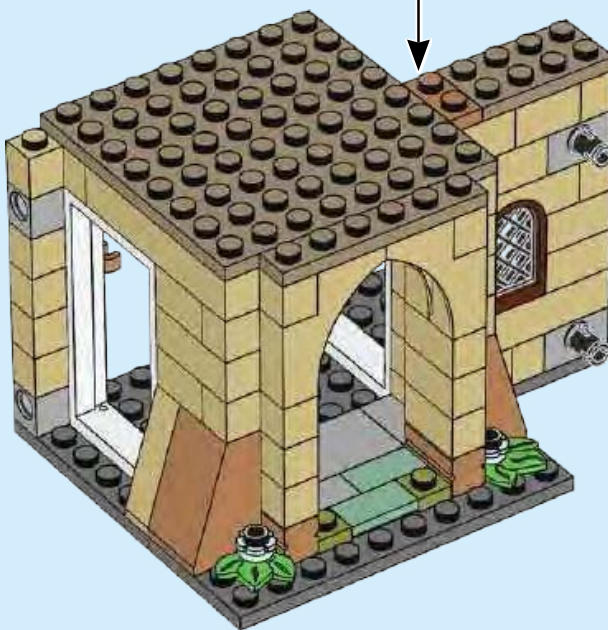



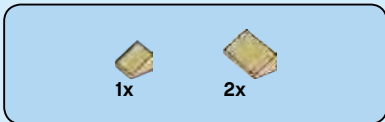

21

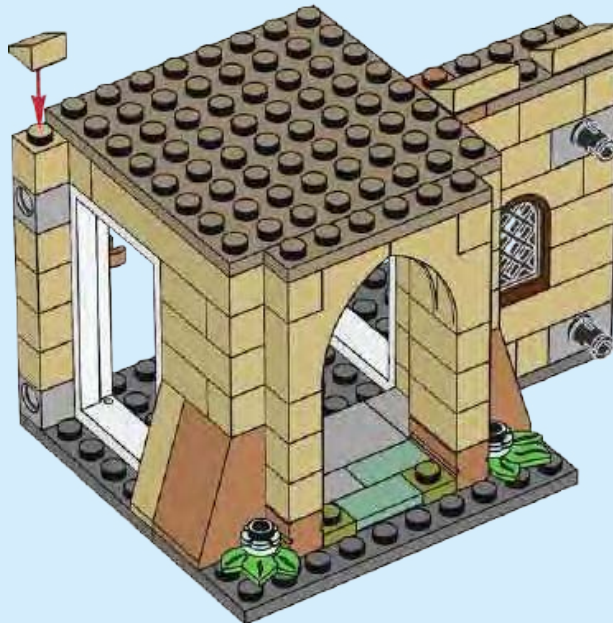

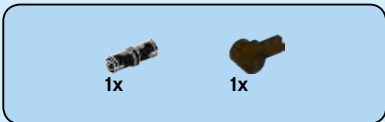

22

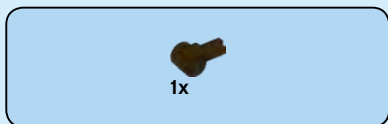

23

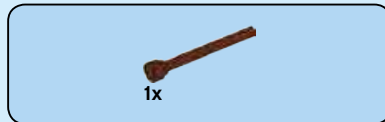

24

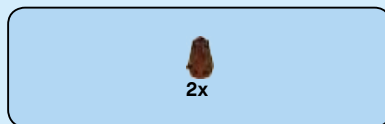

25



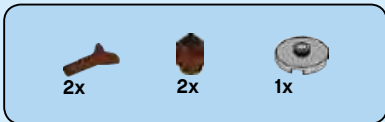

26

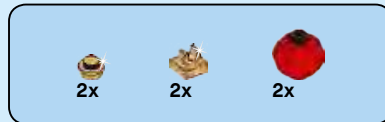
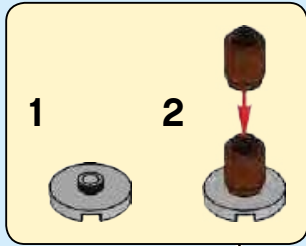

27

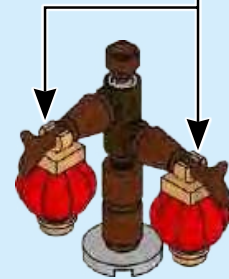

28

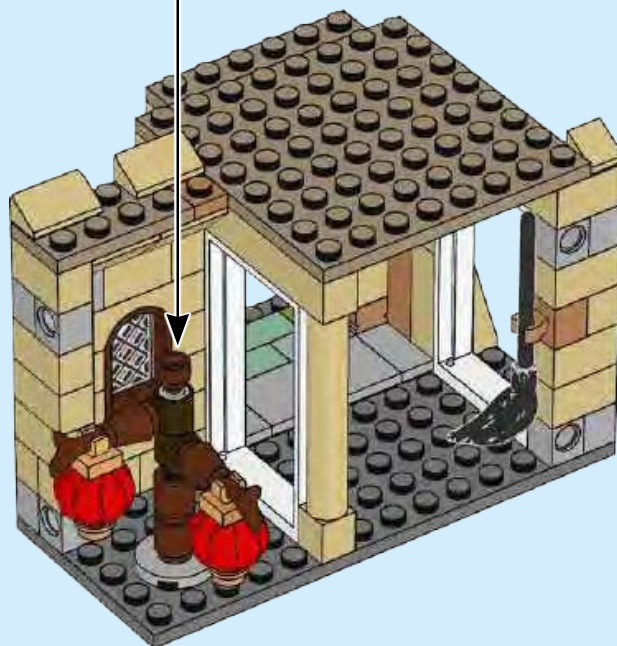

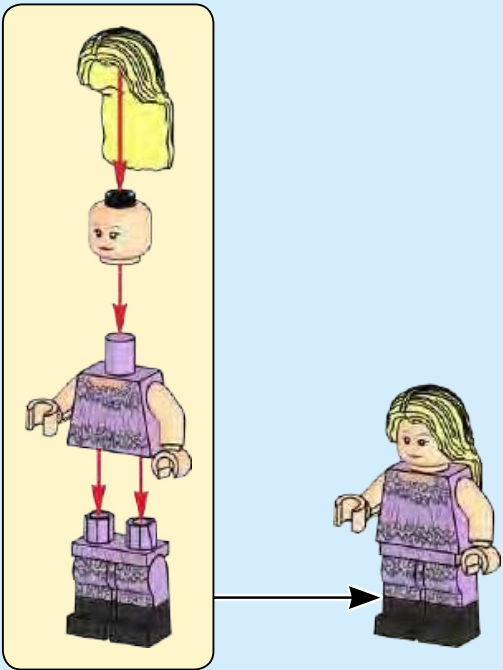
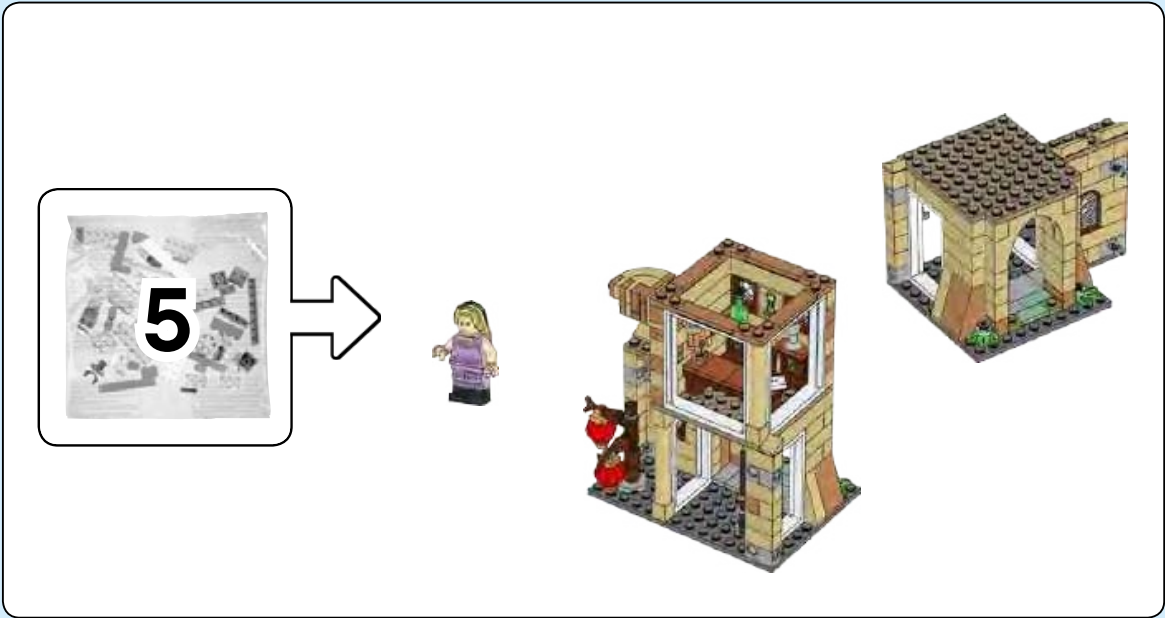

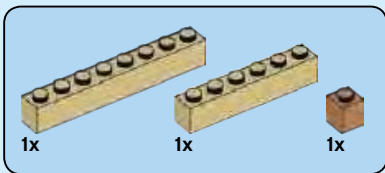

29

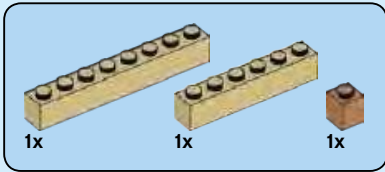
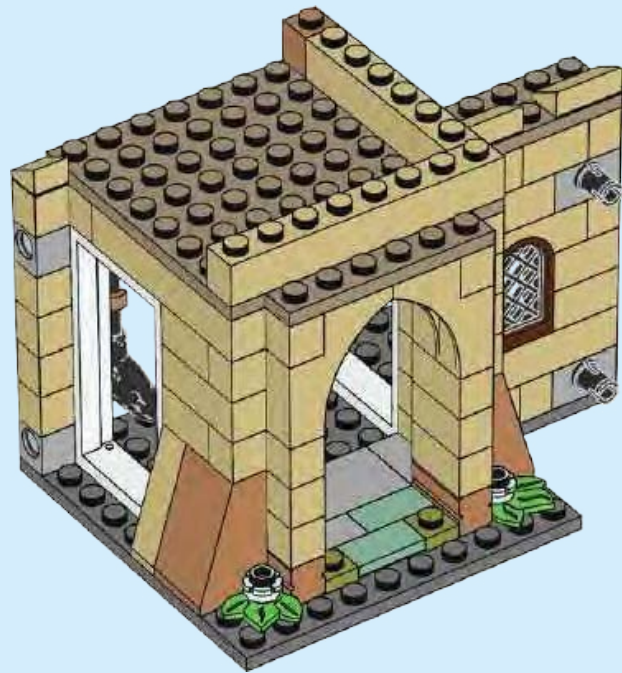

30

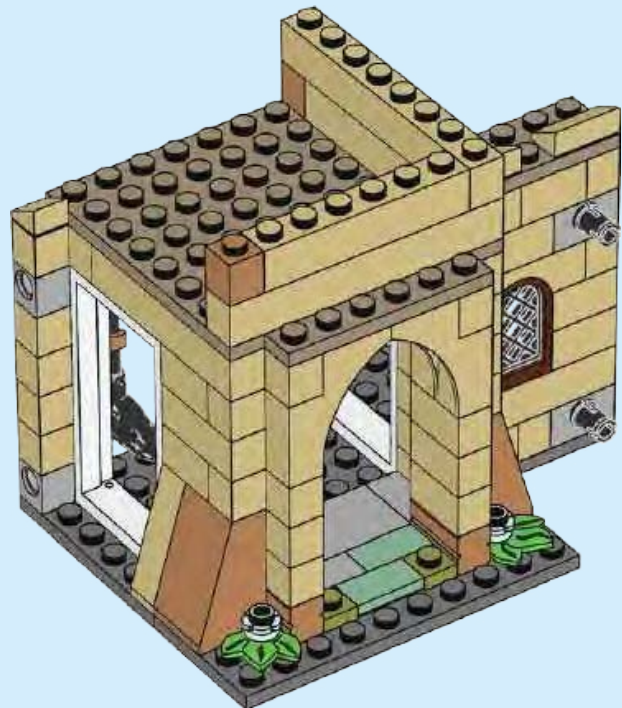



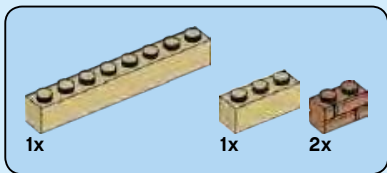

# 31

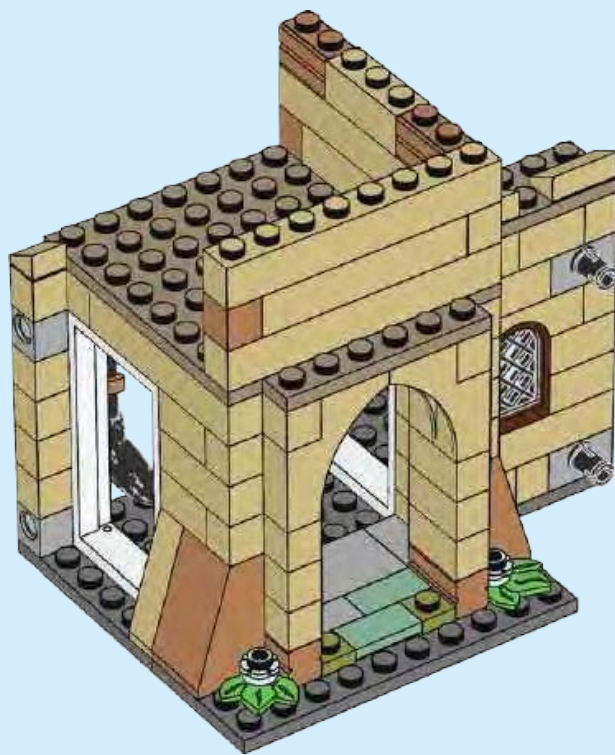

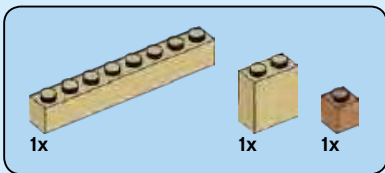

32

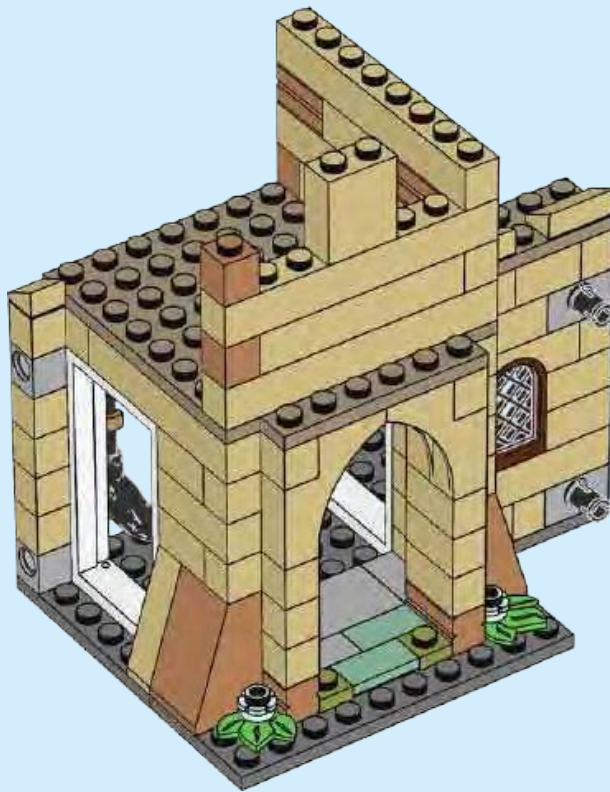
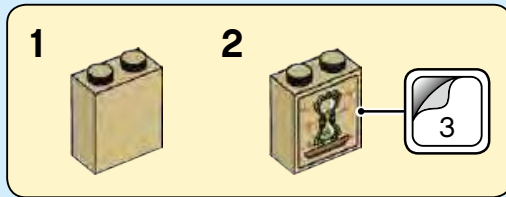

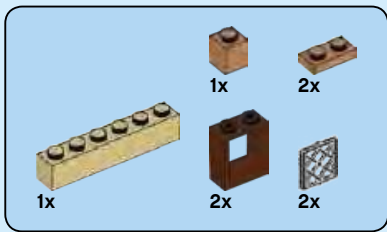

33

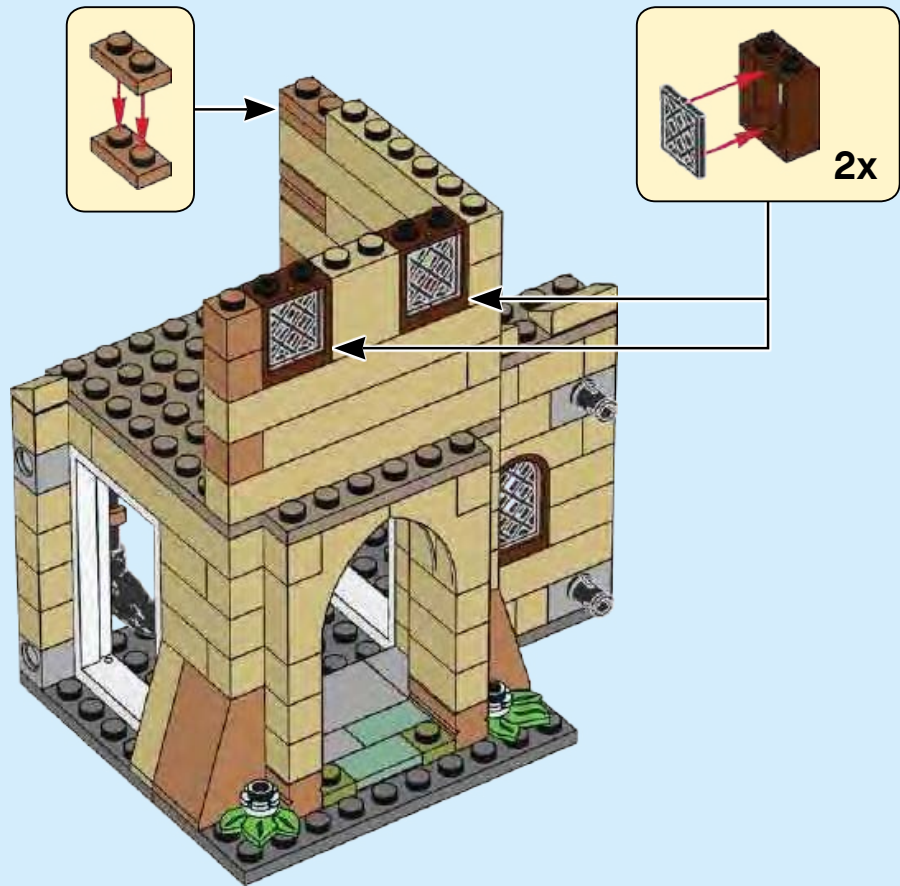

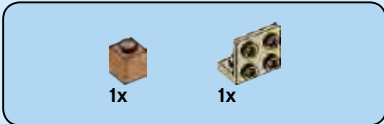

34

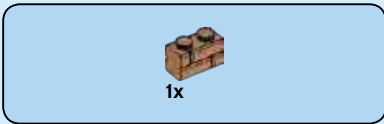
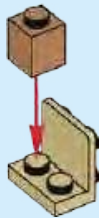

35



36

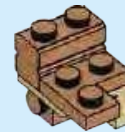

37





38

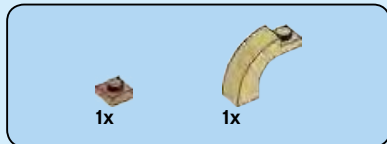

39



40

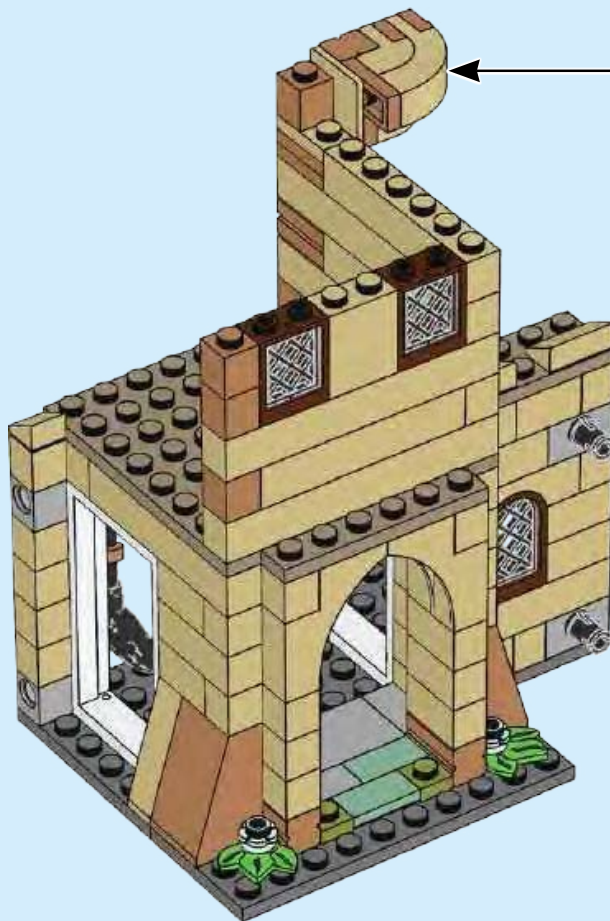



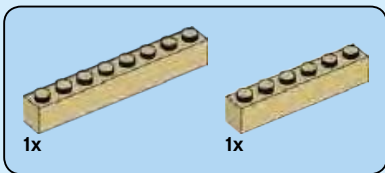

41

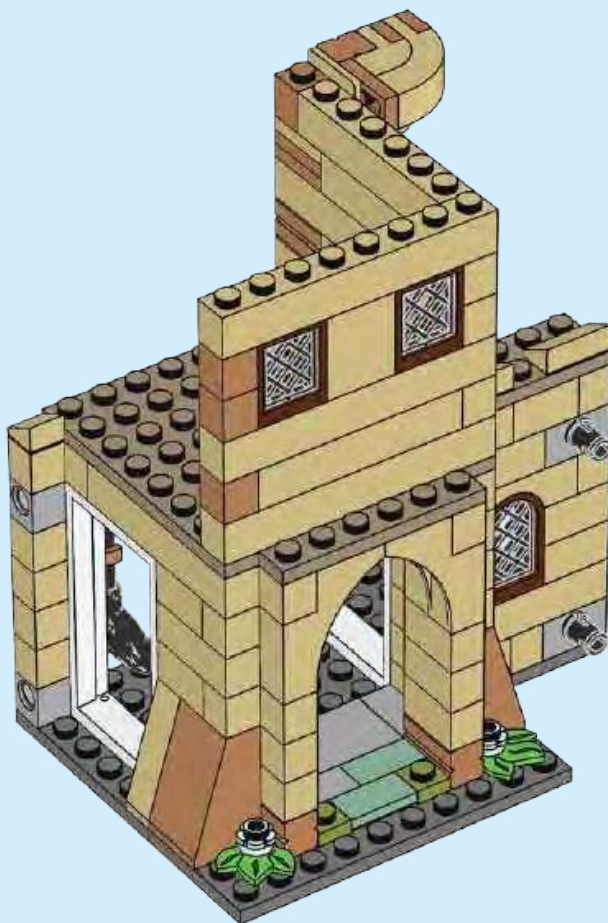

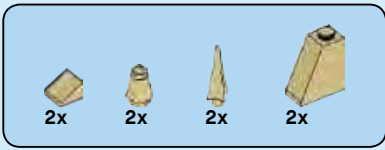

# 42

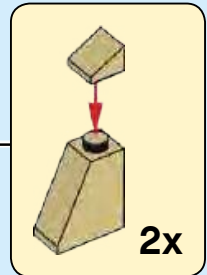
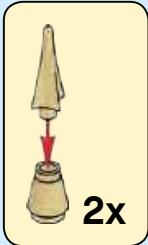

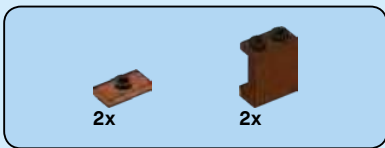

# 43

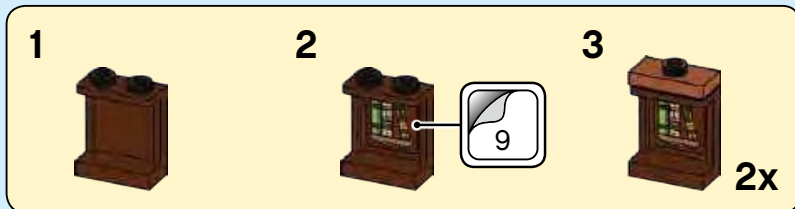

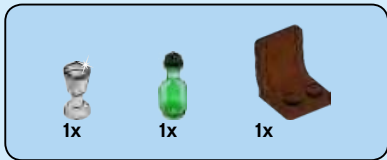

44



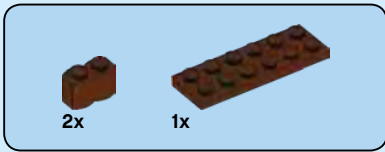

45

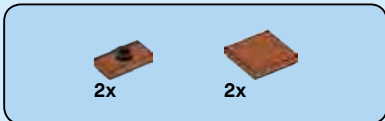
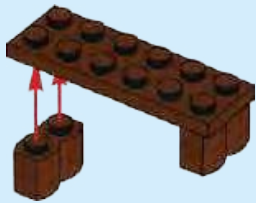

46

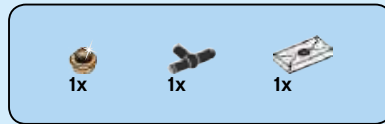

47

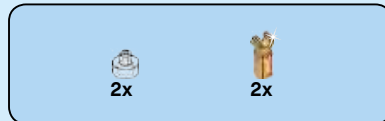

48

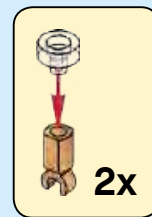



49



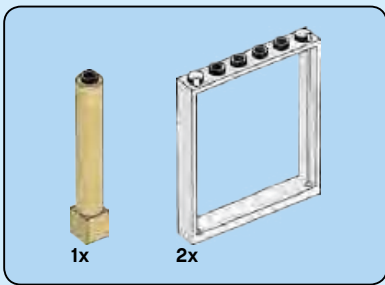

50



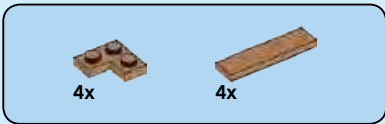

51



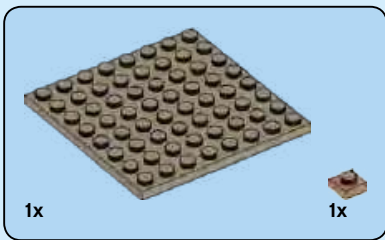

52

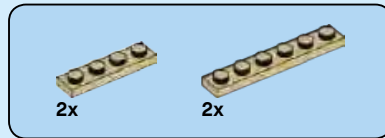

53

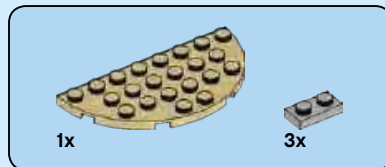

54

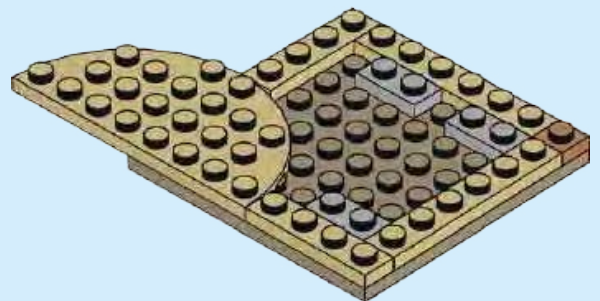

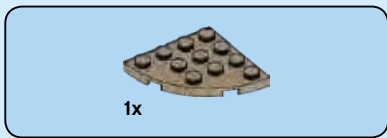

55

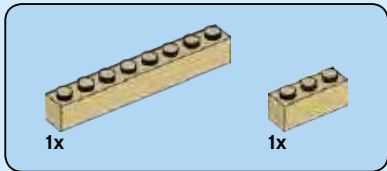
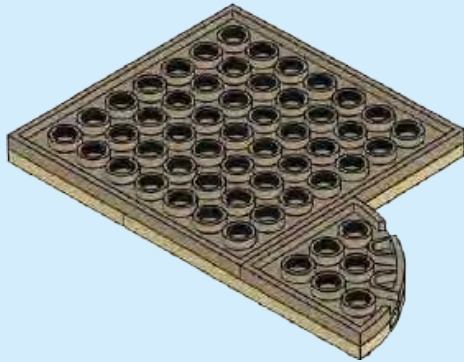

56

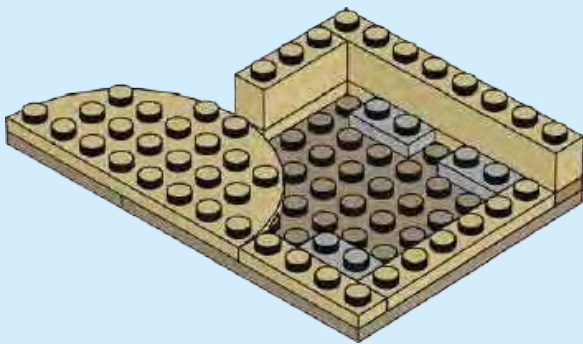

57





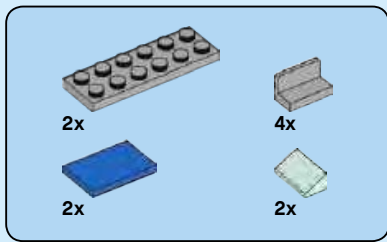

58

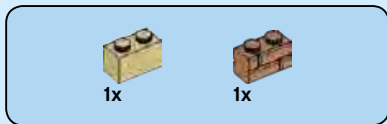
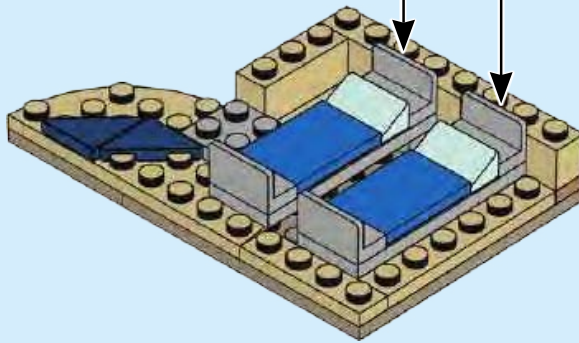
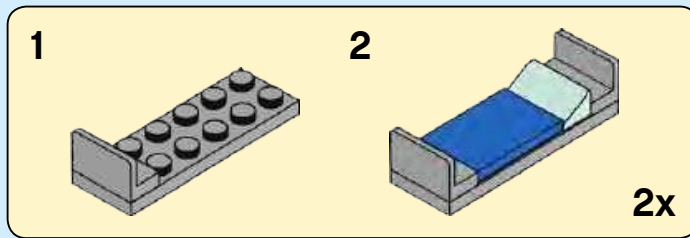

59

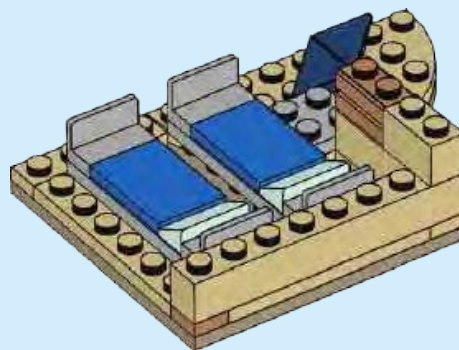

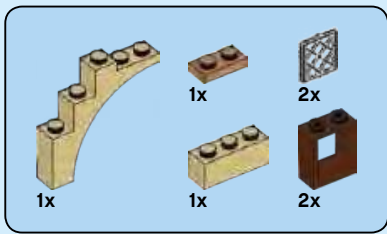

60

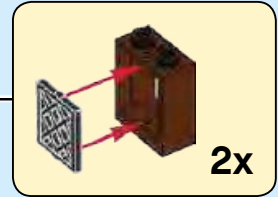
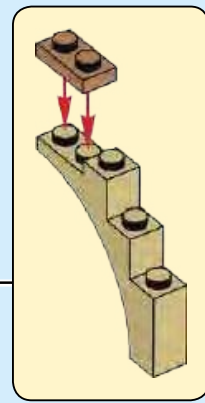
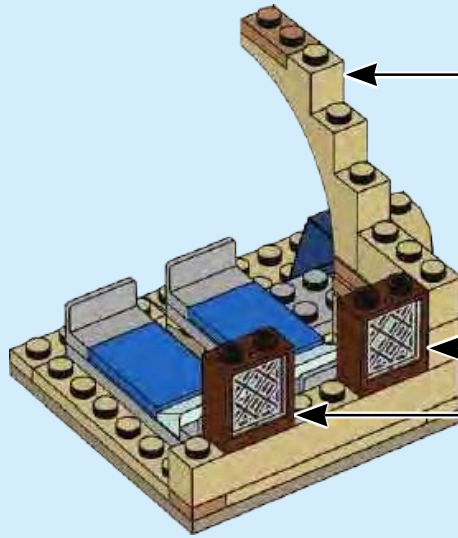

61

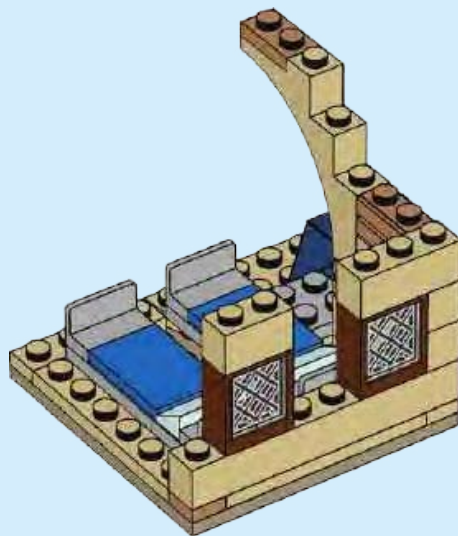



62

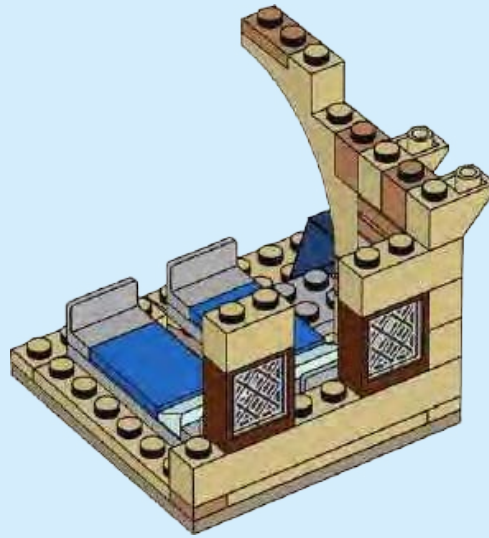

63

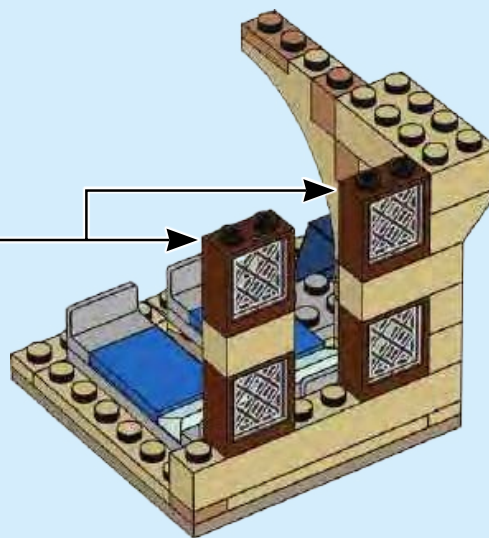
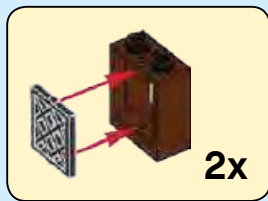

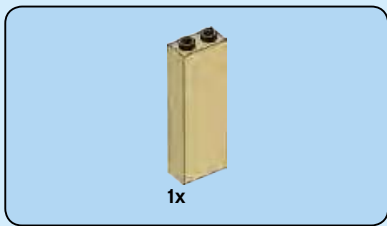

# 64

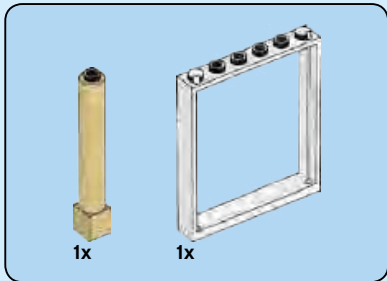
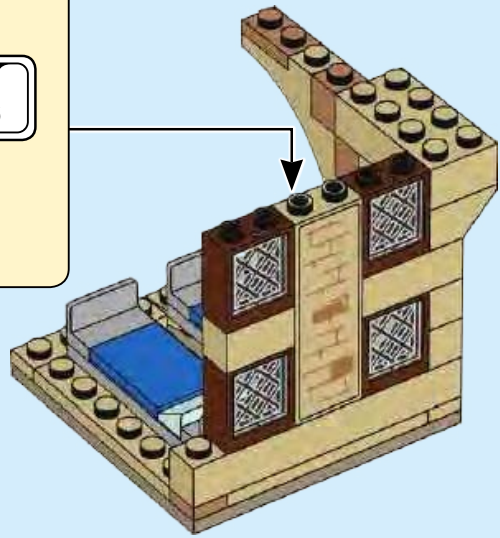
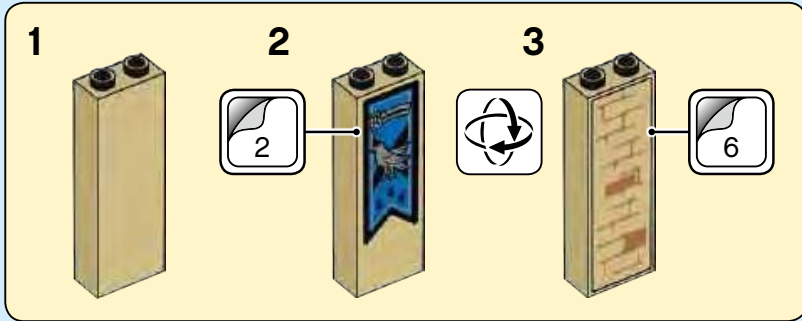

# 65

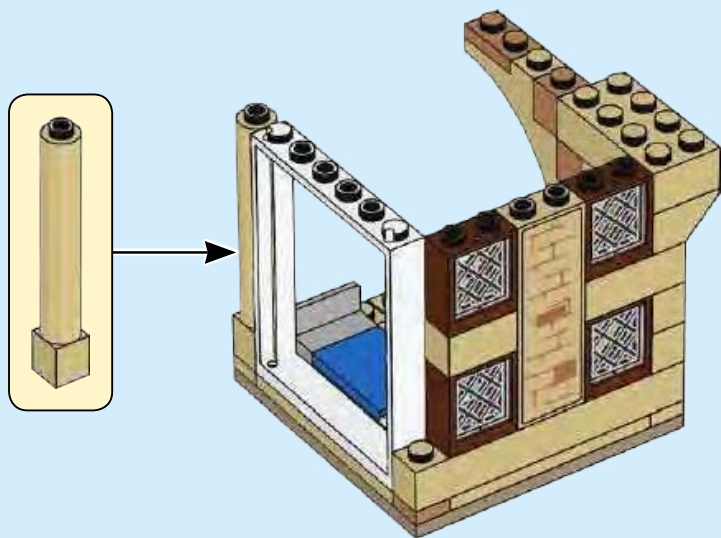

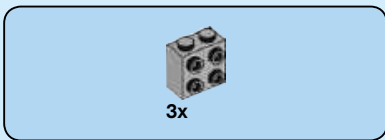

66

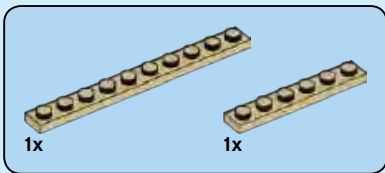
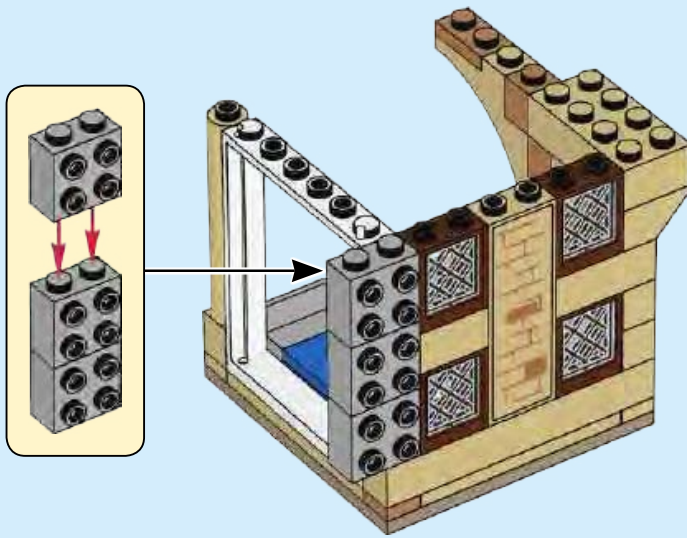

67

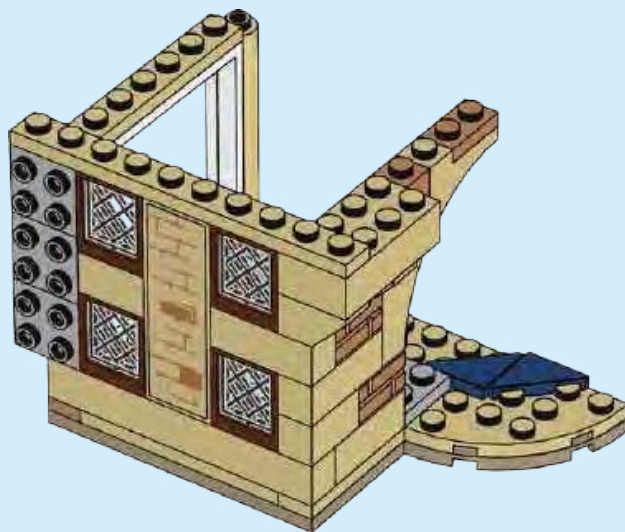





68

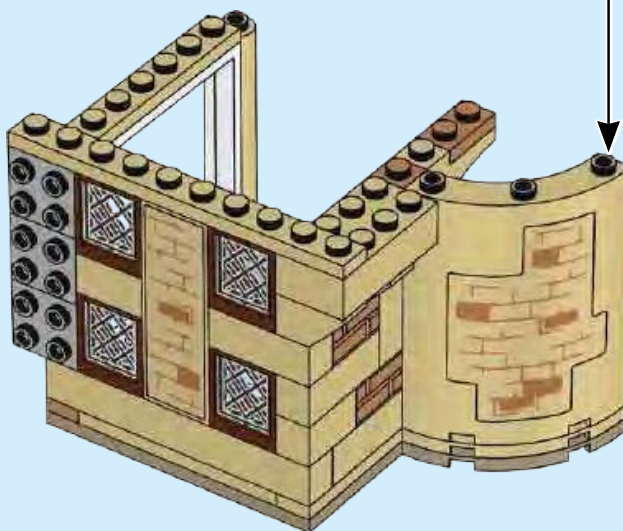
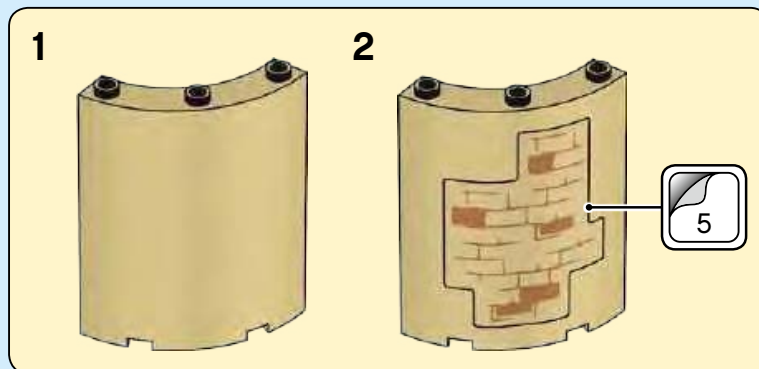

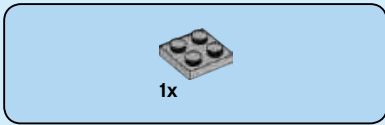

69

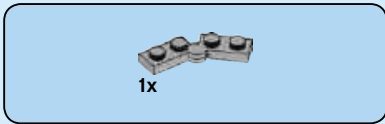
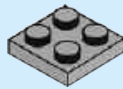

70

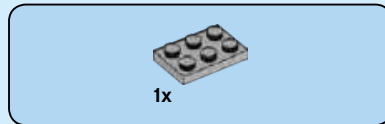
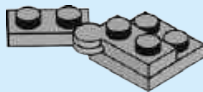

71

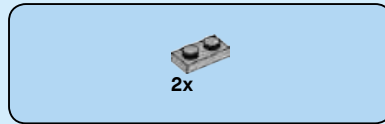
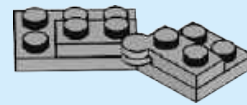

72

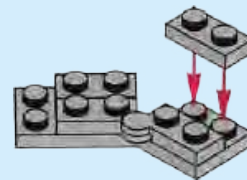

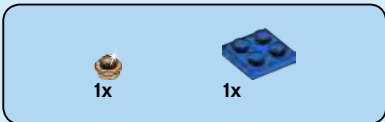

73

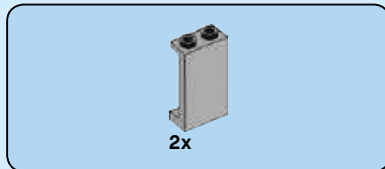
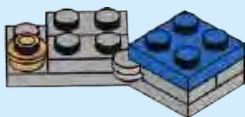

75

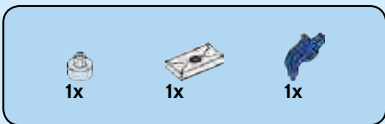
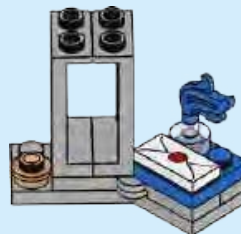

74

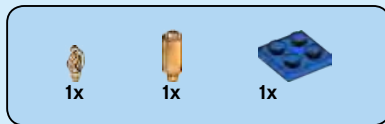
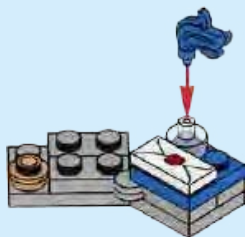

76

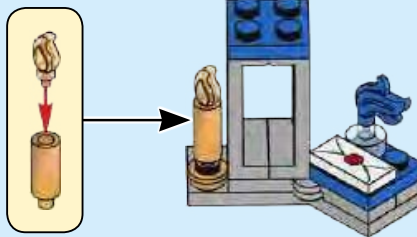

77





78

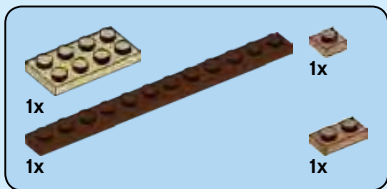
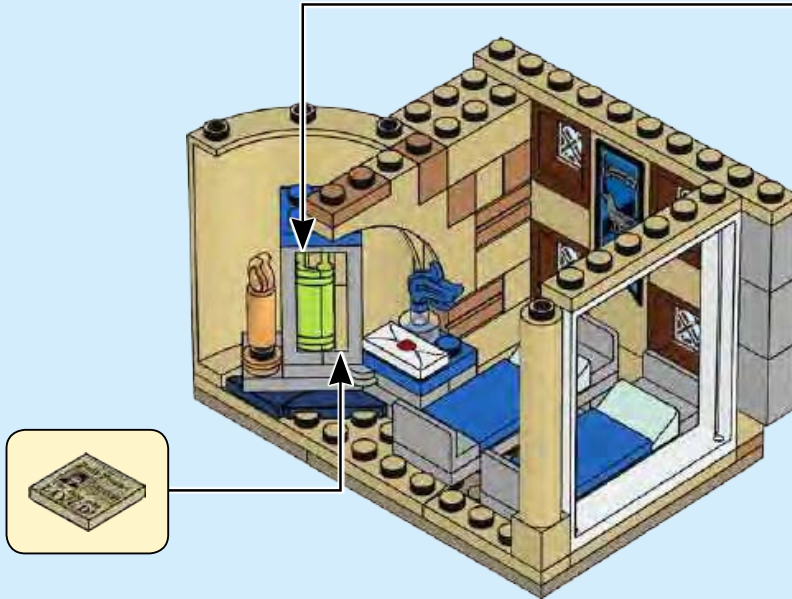
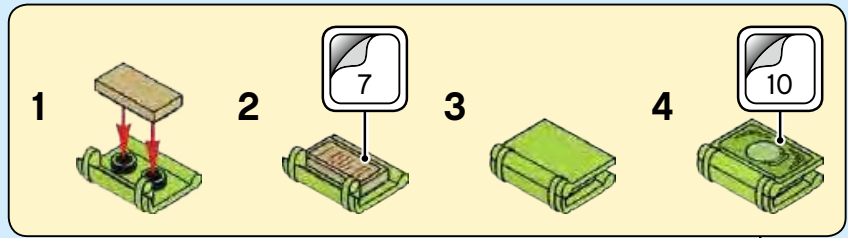

79

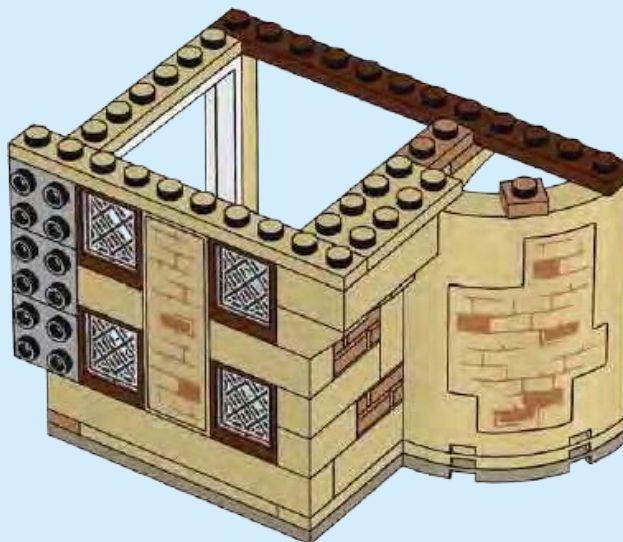



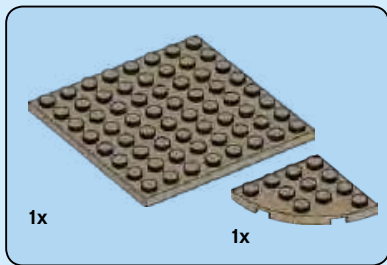

80

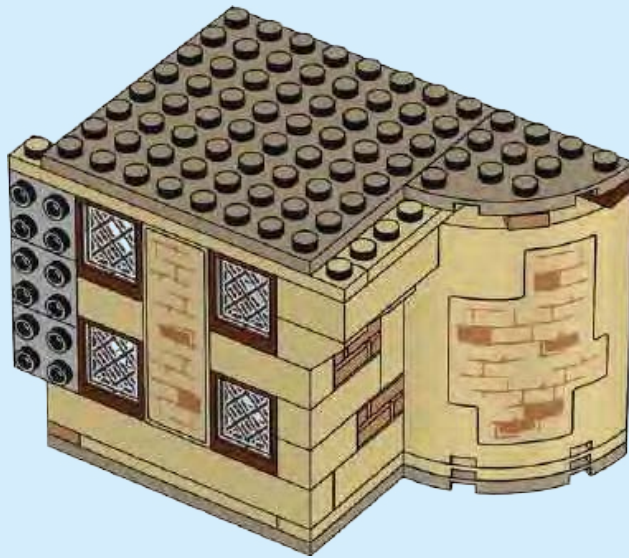

81

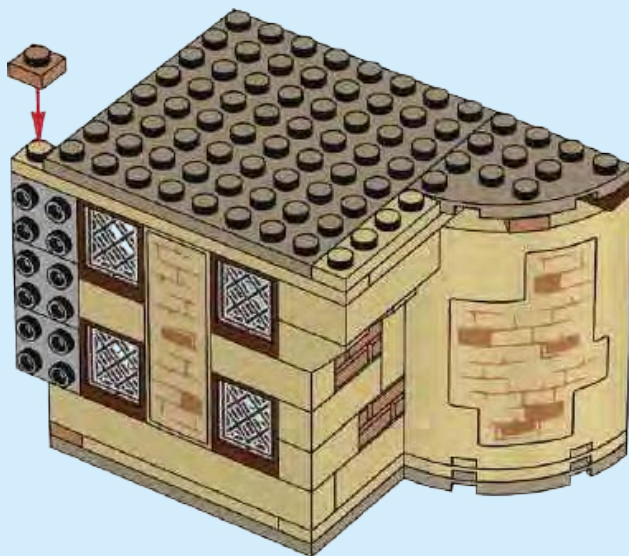

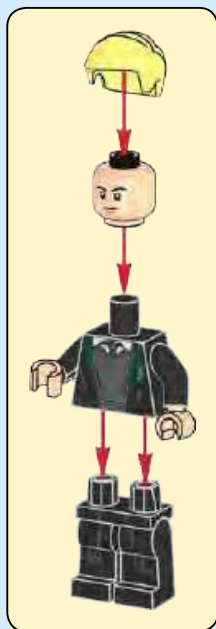

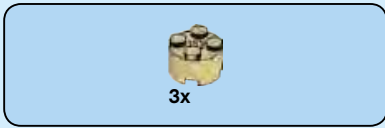

3x

82



1x

83

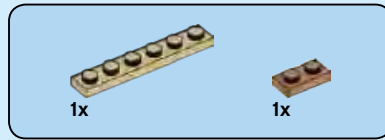

1x

1x

84

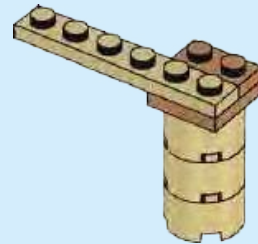

1x

85

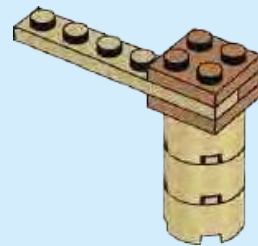

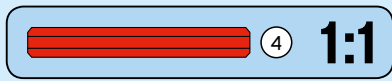
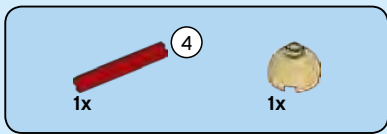

86

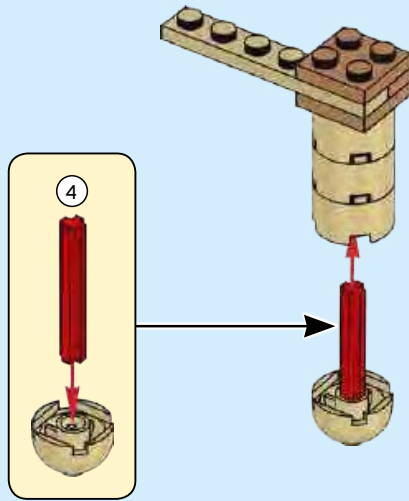

87

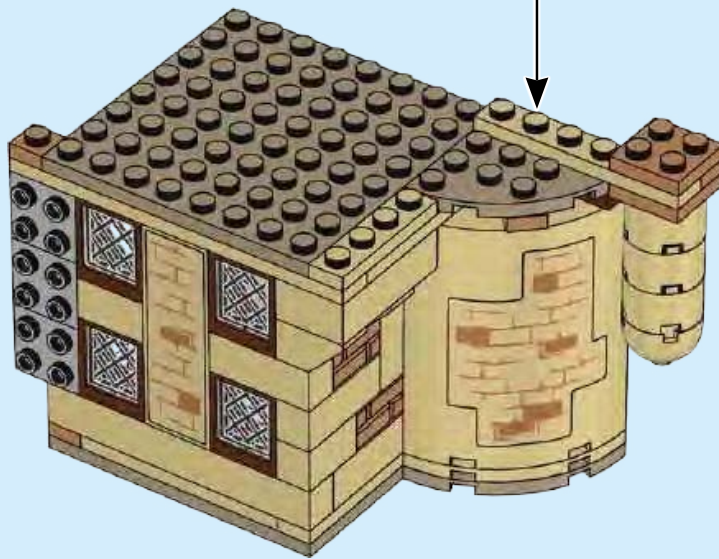



88

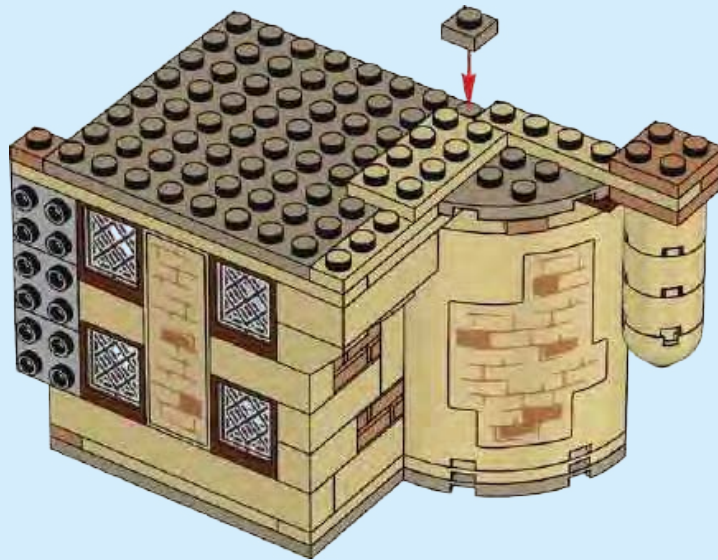

89

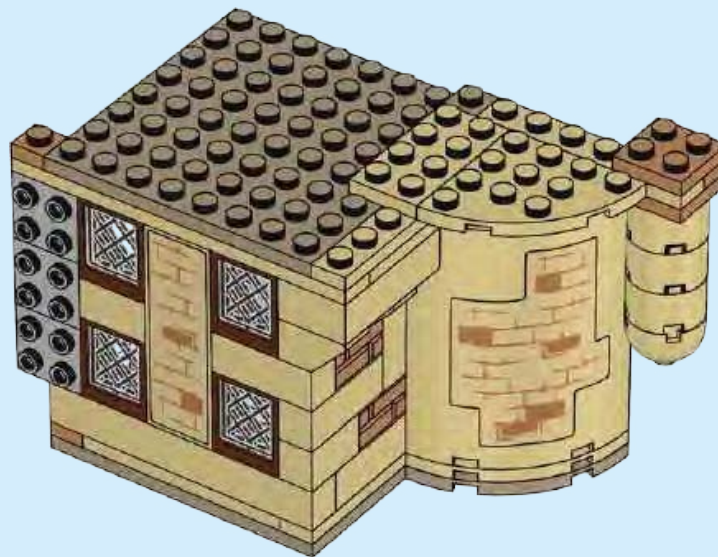



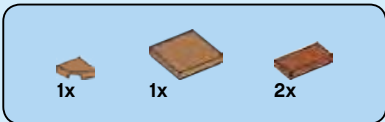

90

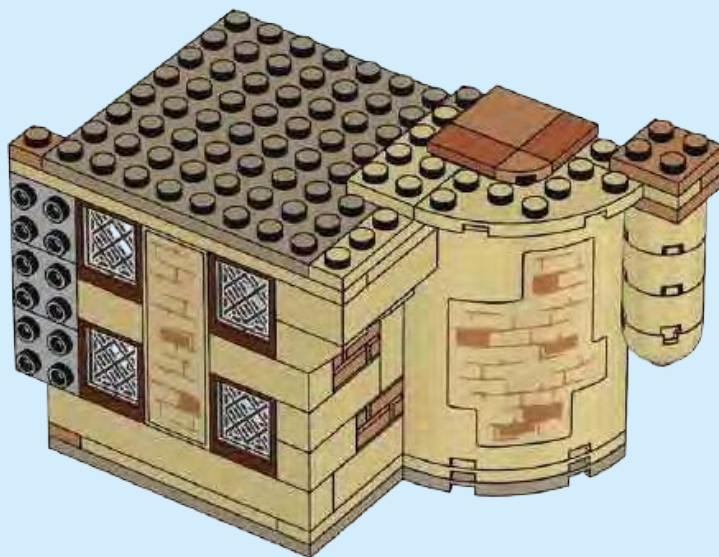

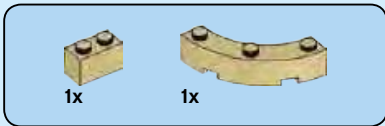

91

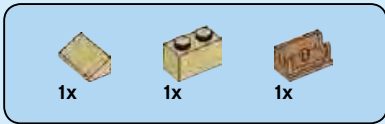
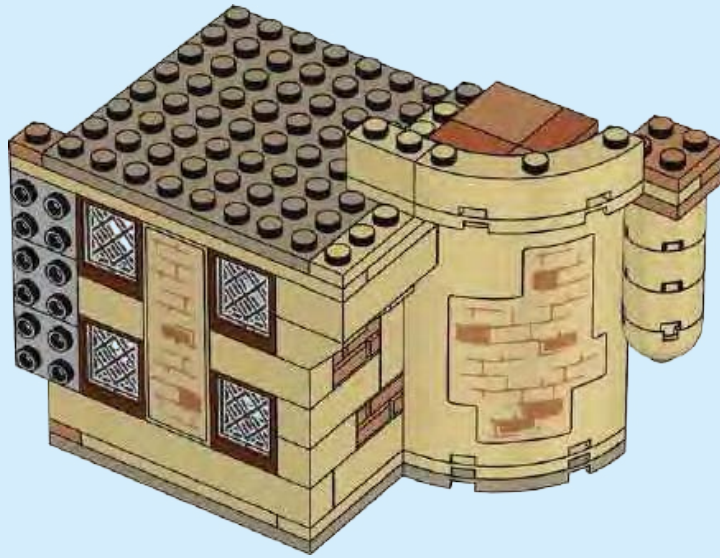

92

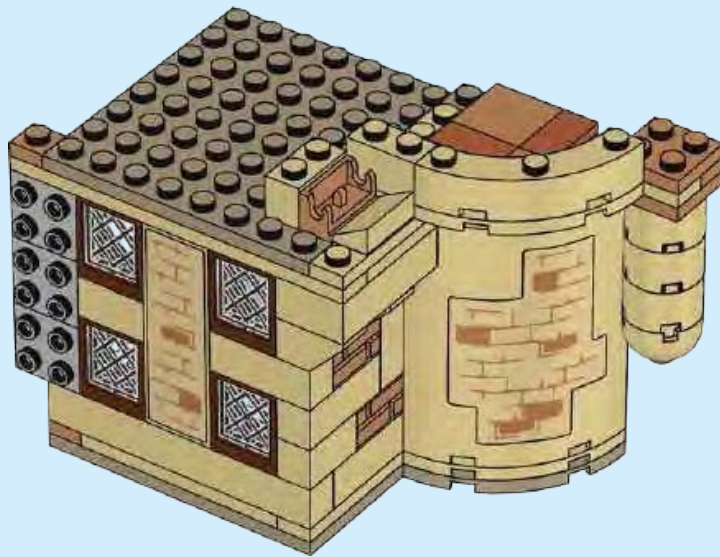

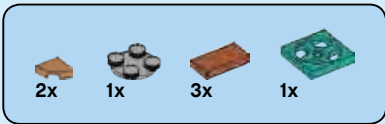

93

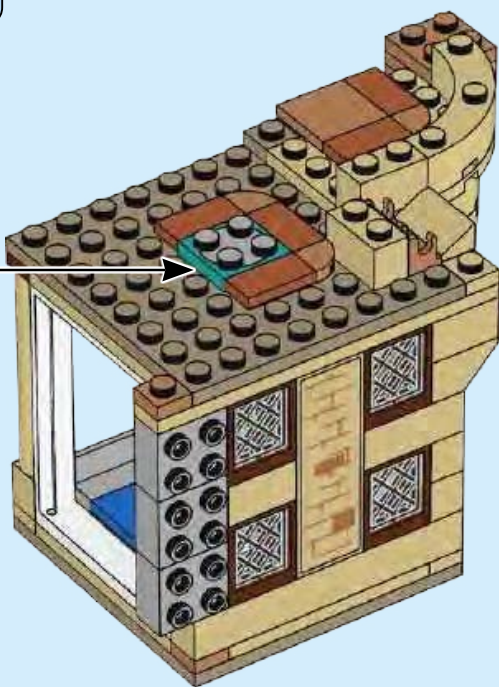

94

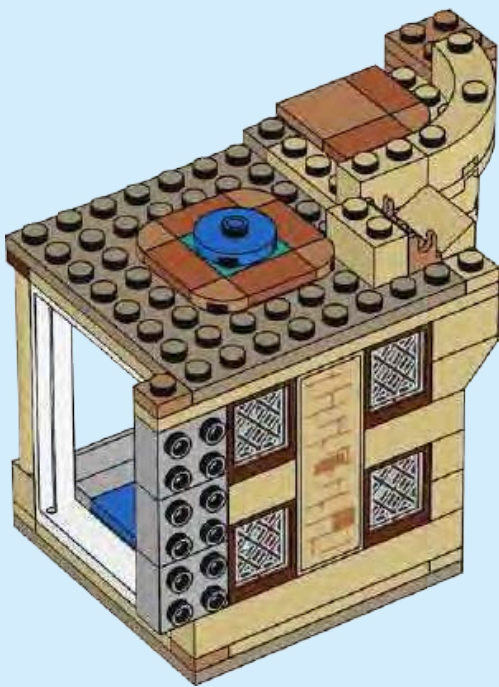

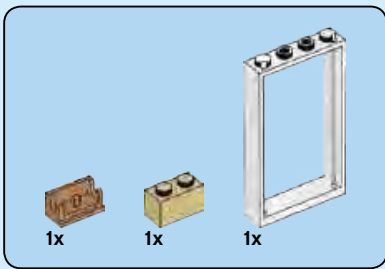

95

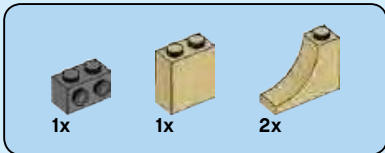
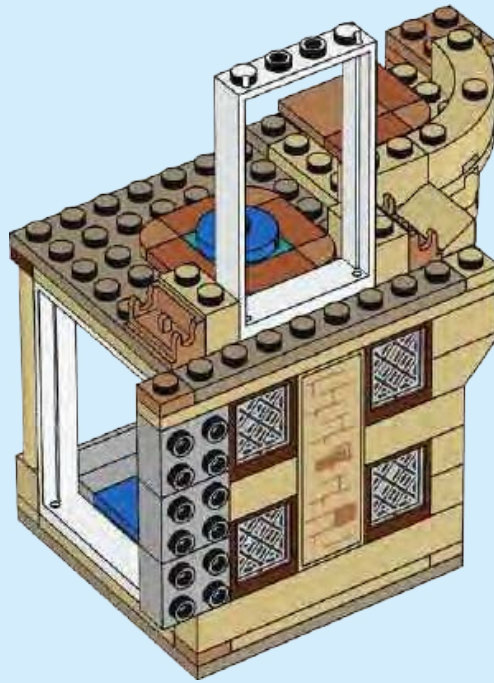

96

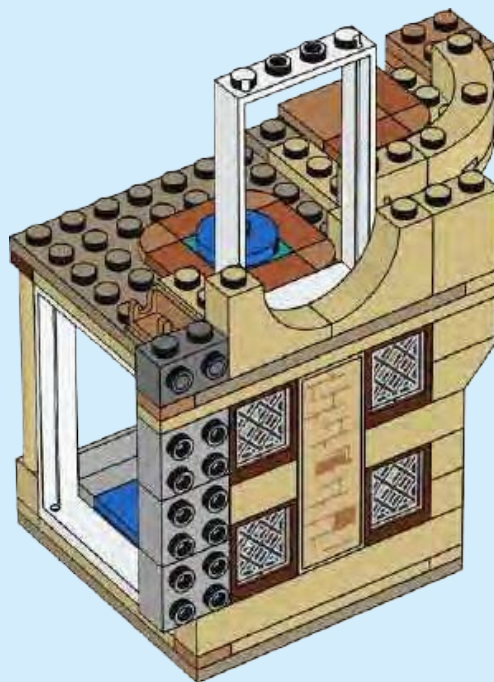



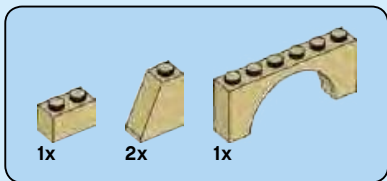

97

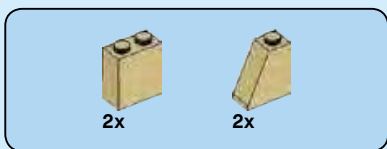
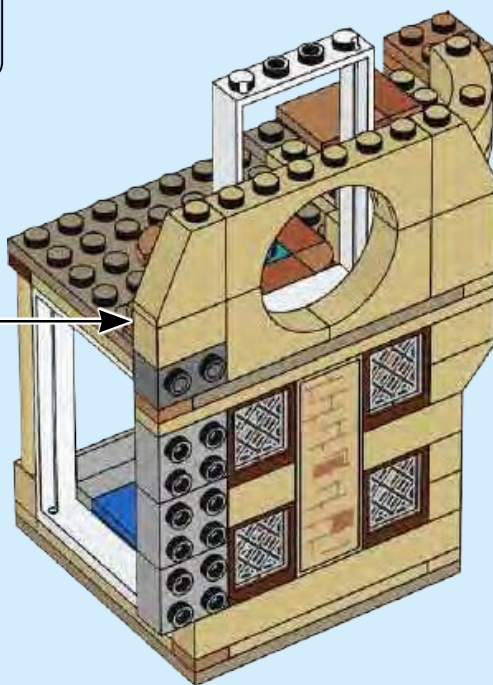
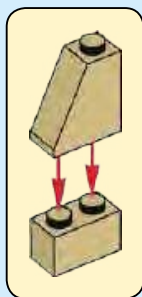

98

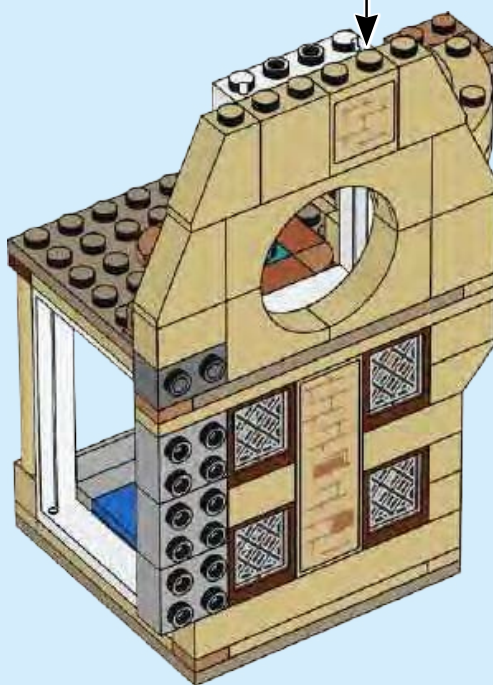
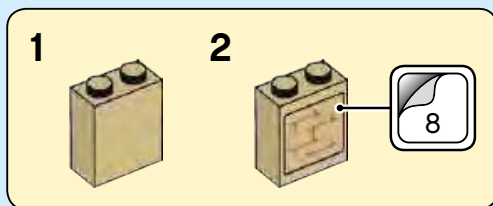



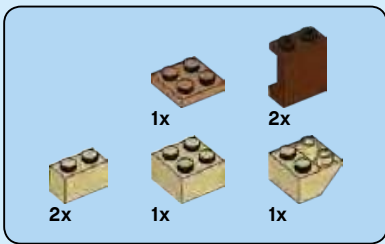

99

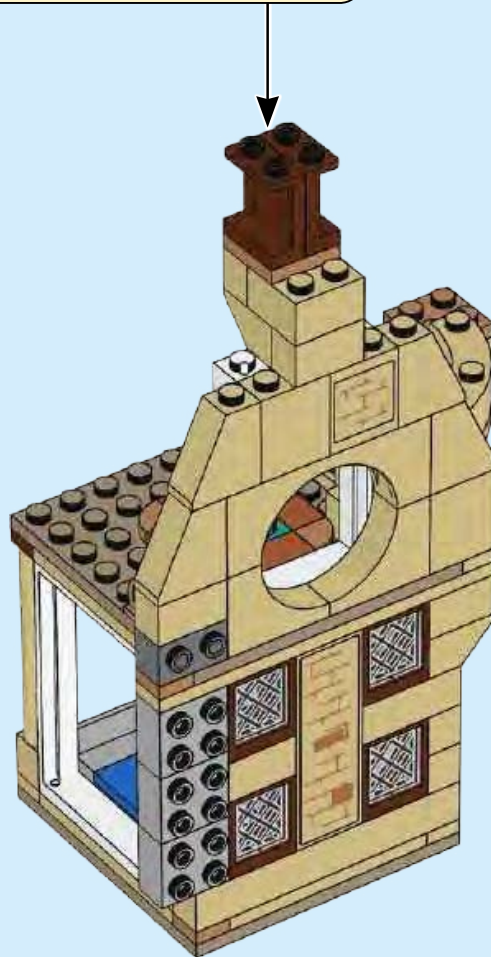
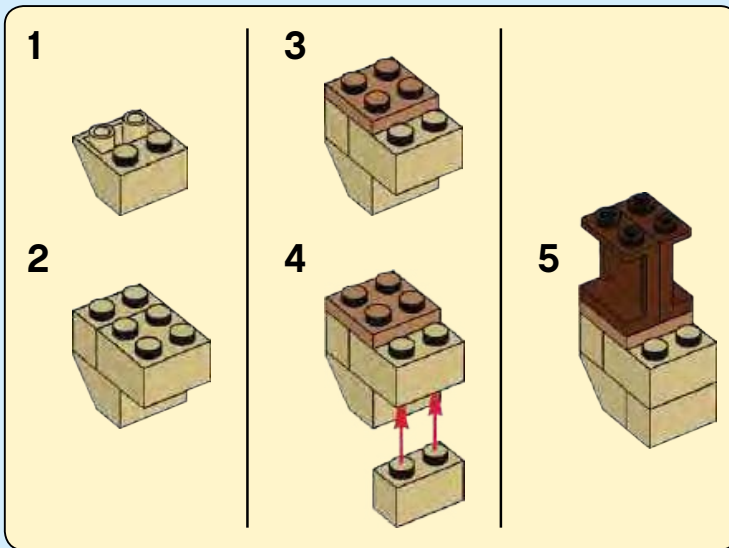

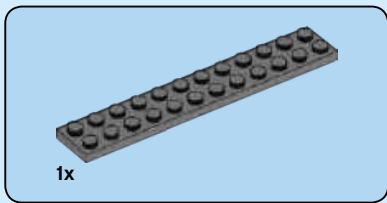

100

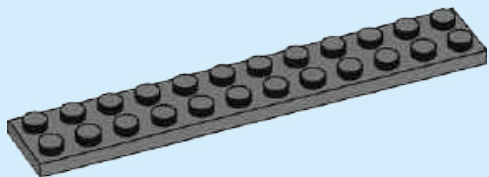

102

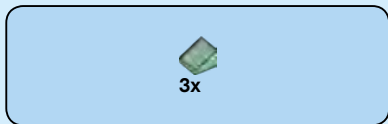
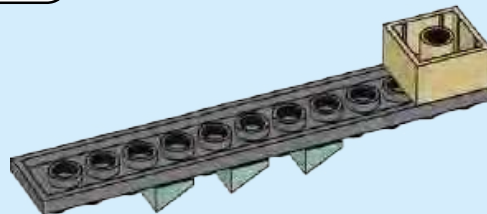
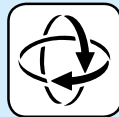

101

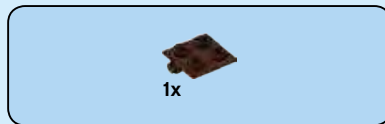
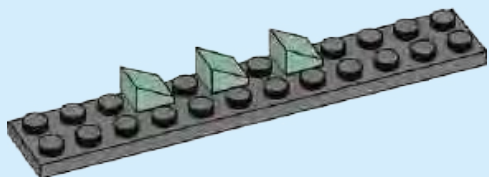

103

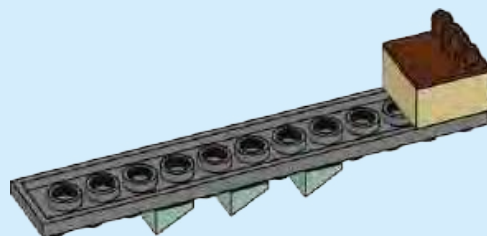

104

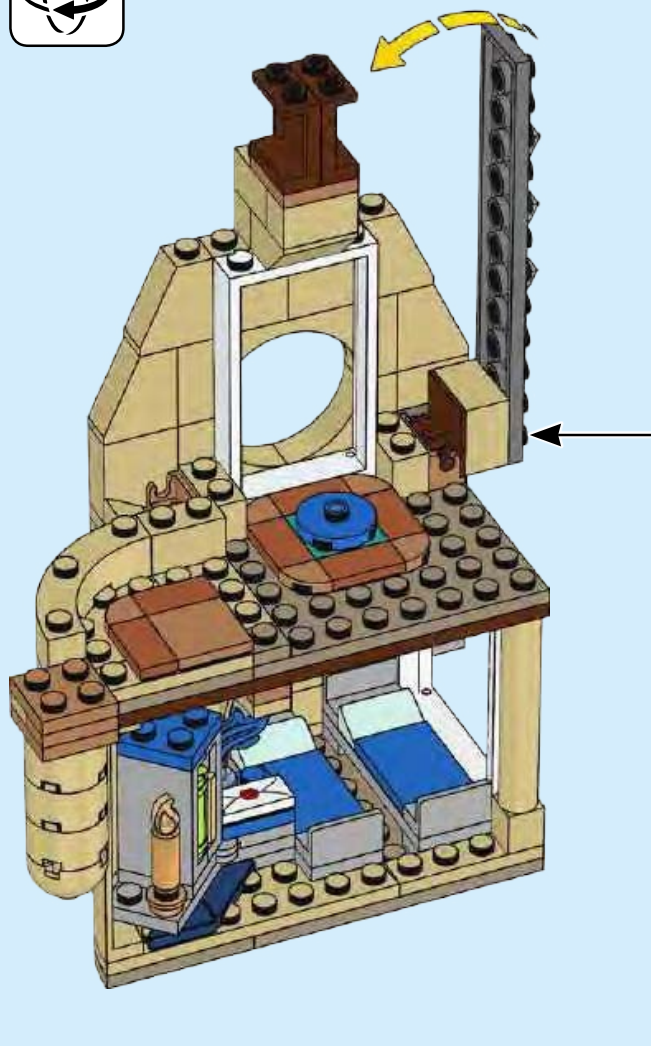

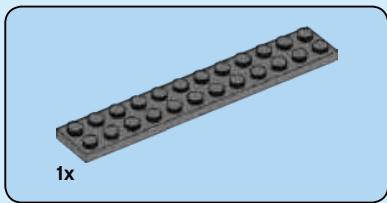

105

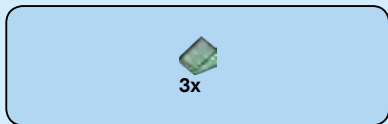
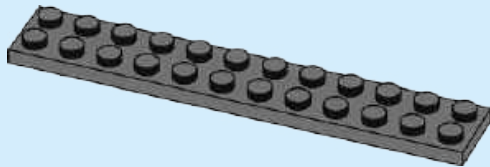

106

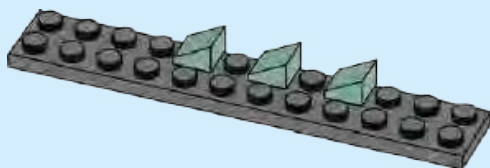

107

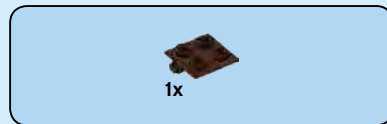
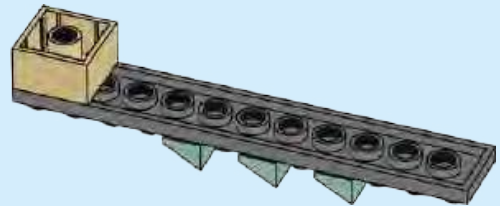
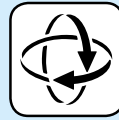

108

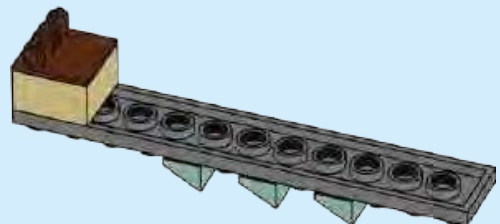

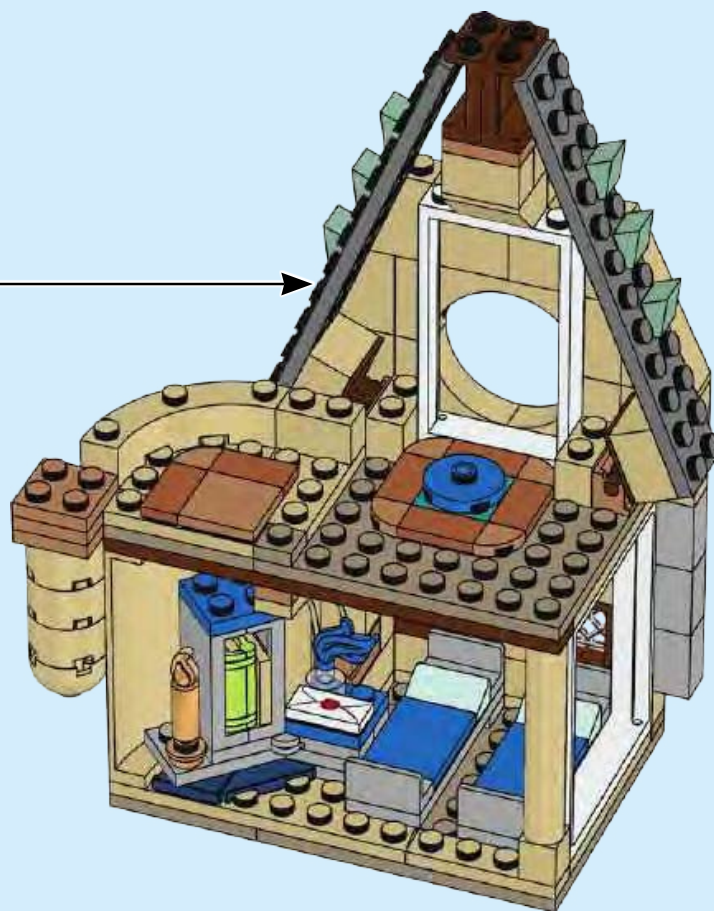



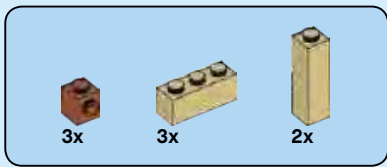

110

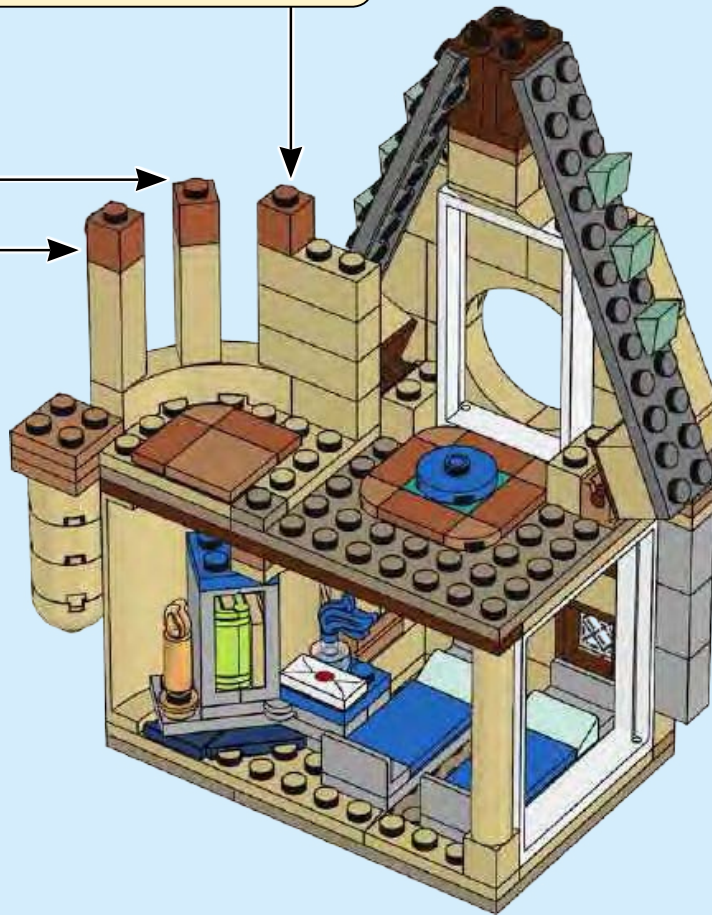
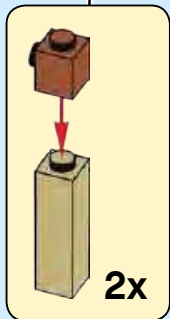
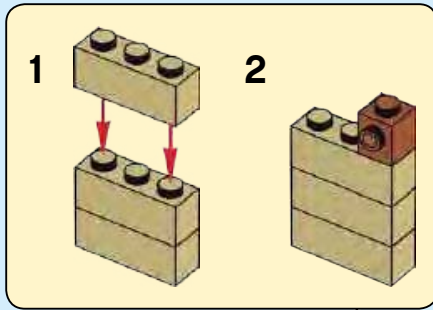

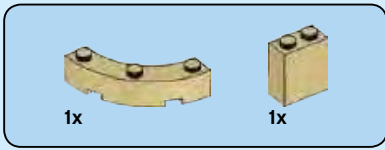

111



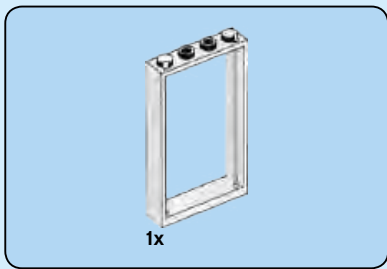

112



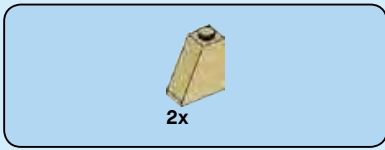

113

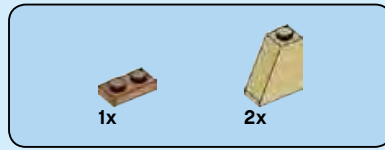
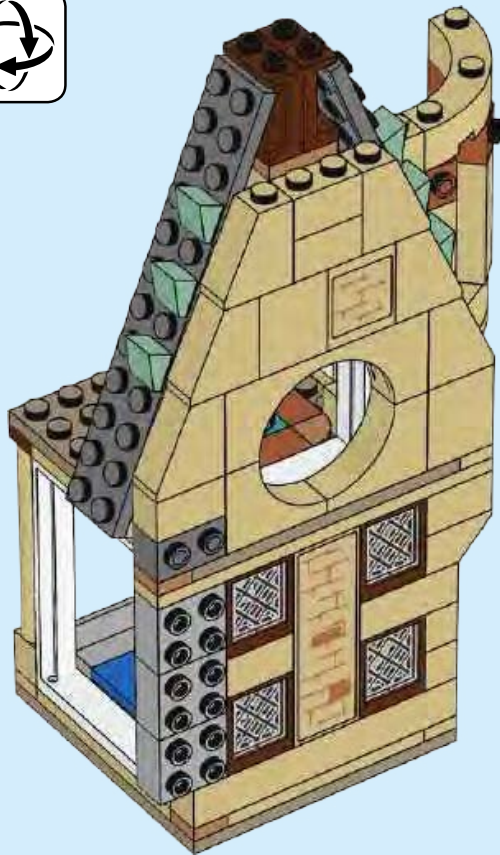

114





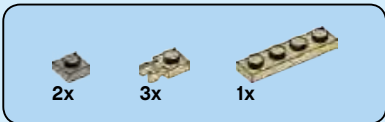

# 115

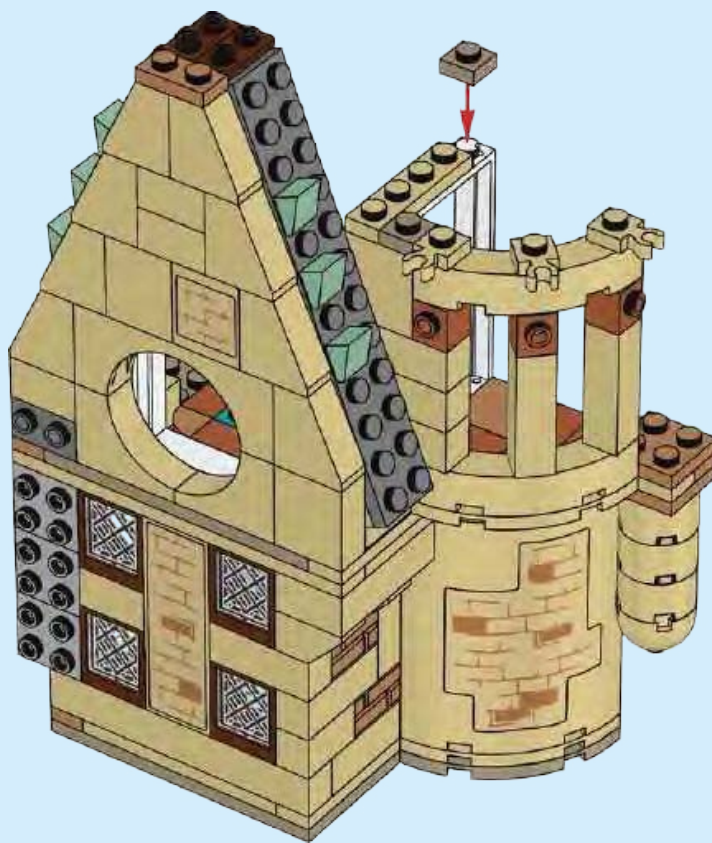



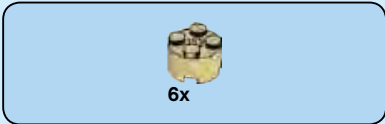

116

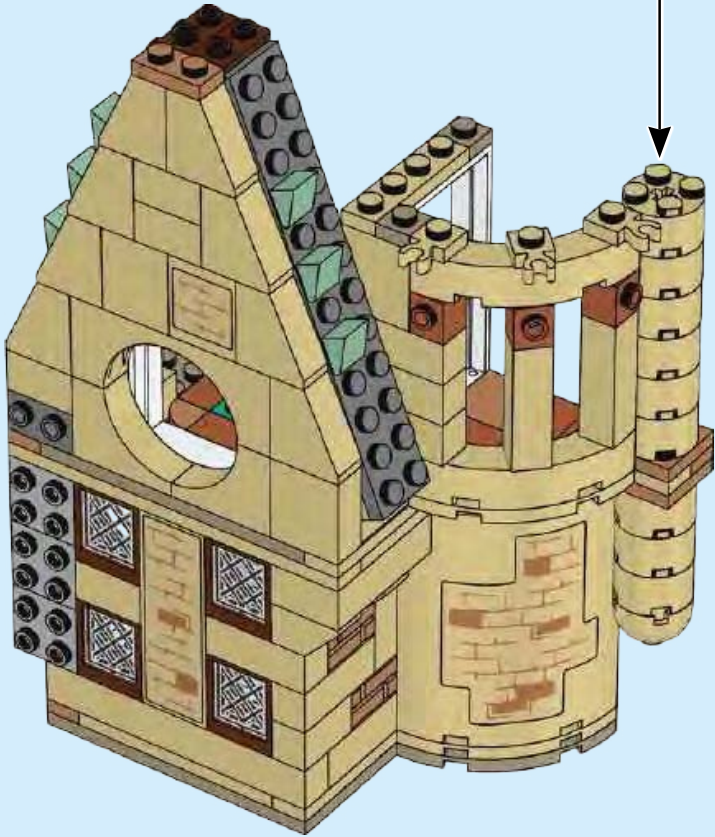
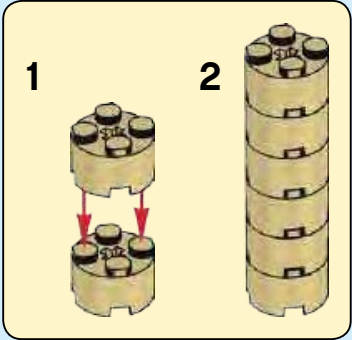

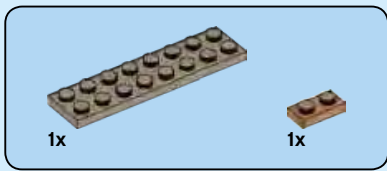

117

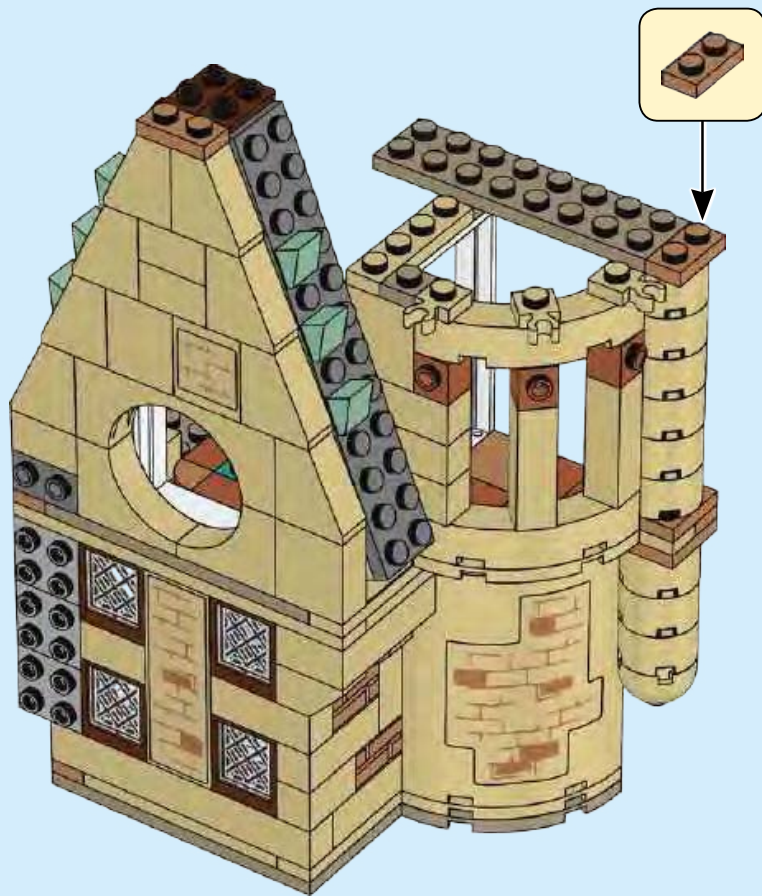

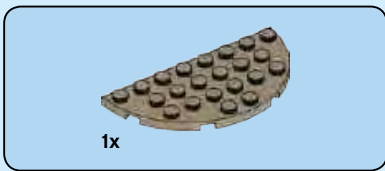

118



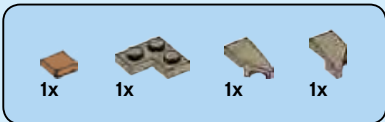

# 119





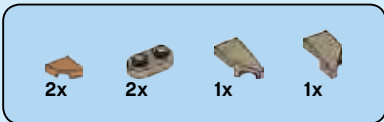

# 120

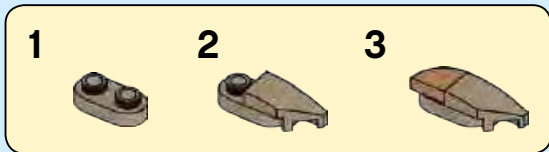





121



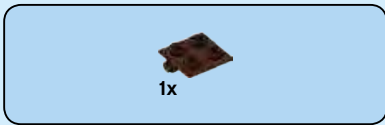

122

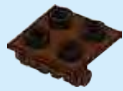

123

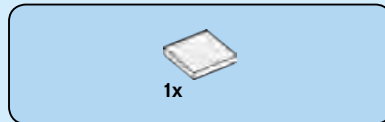

124

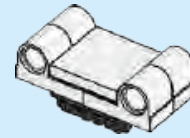

125





4x

# 126

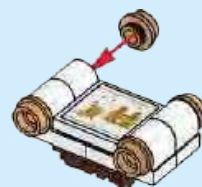

1x



2x



1x

# 127

1



2



128



129



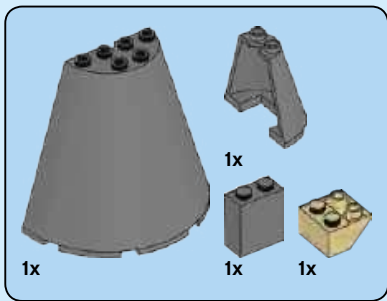

130

1

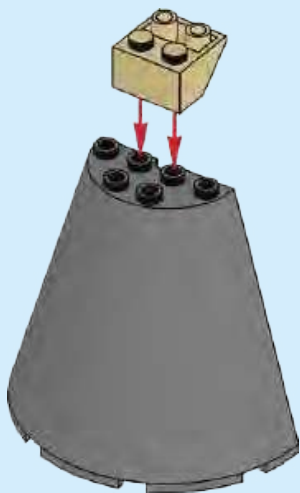

2

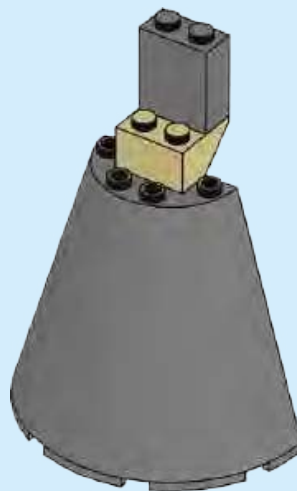

3

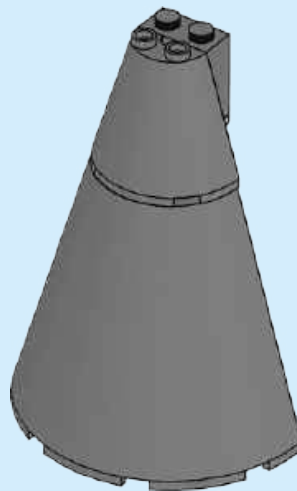



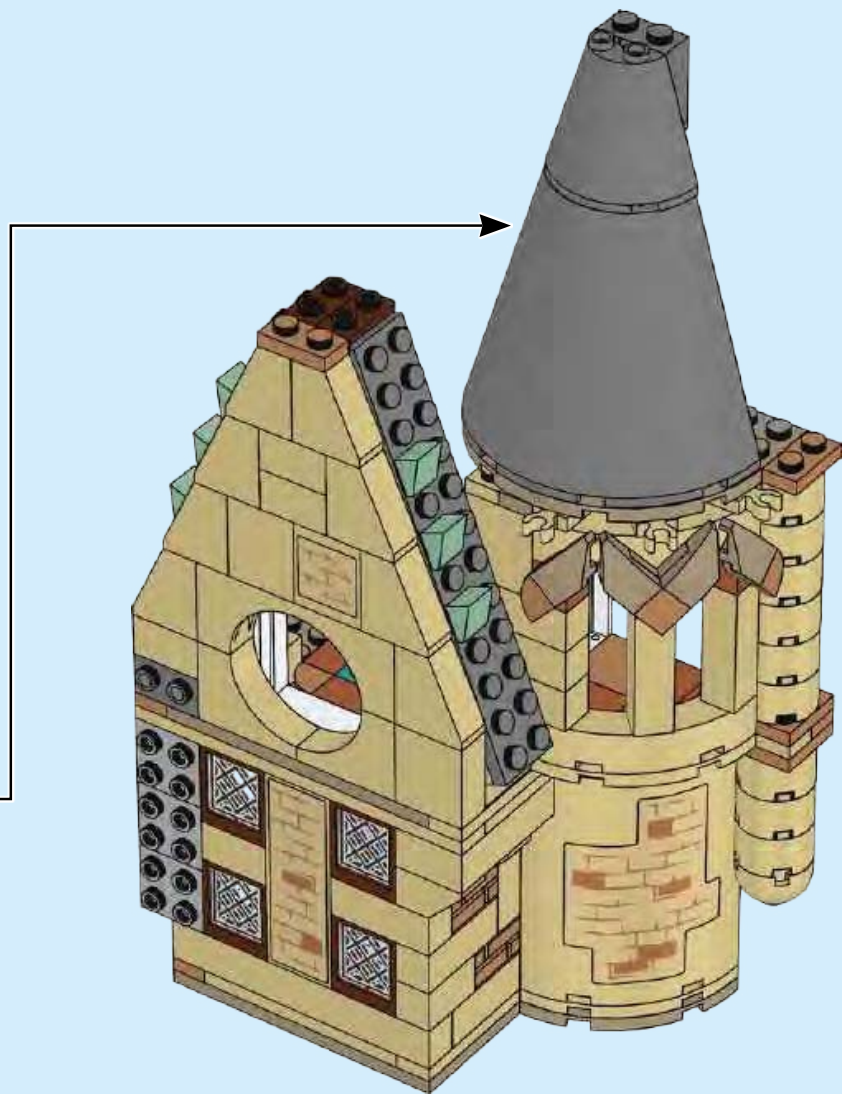

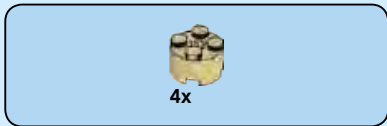

131



132



133

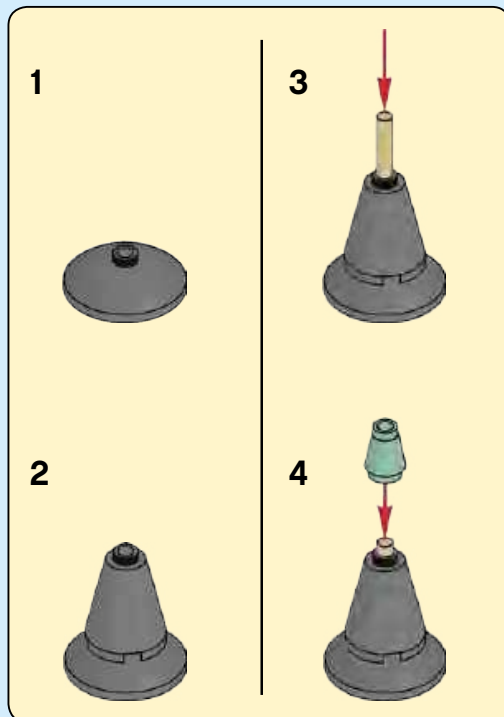

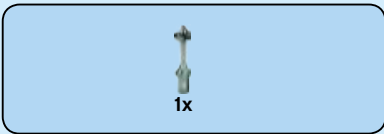

134



135

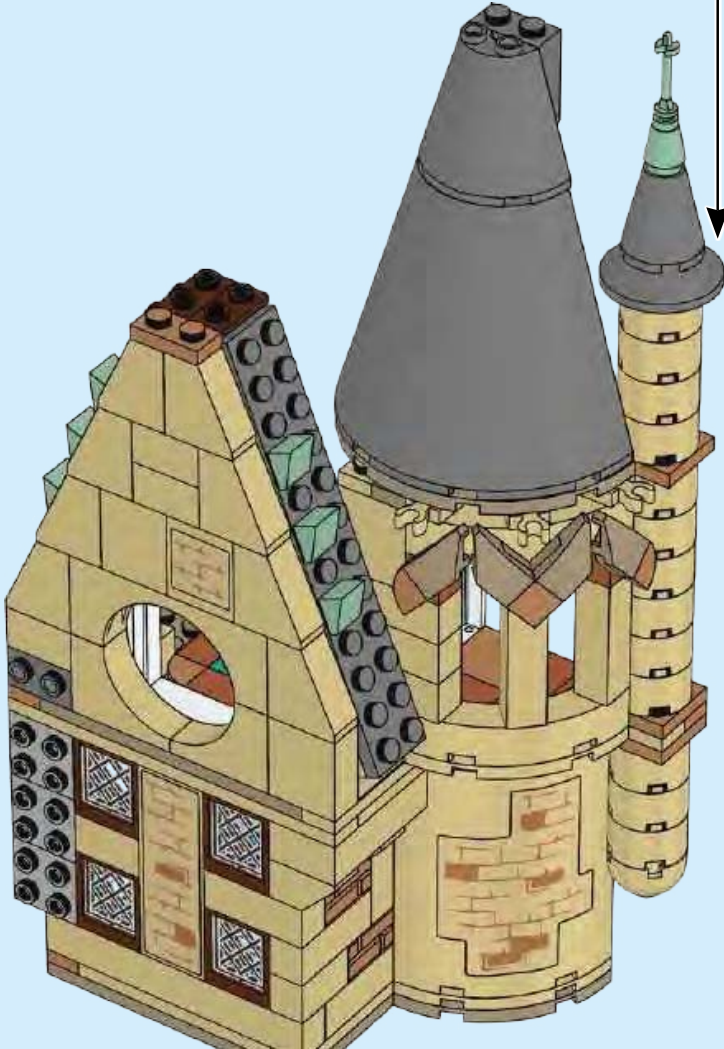



**136**

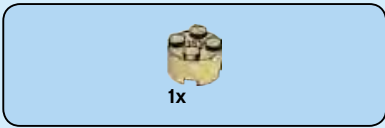

**137**

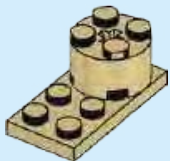

**138**

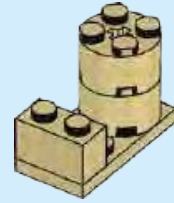

**139**

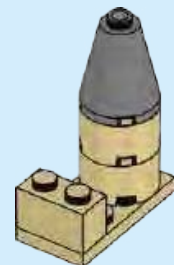

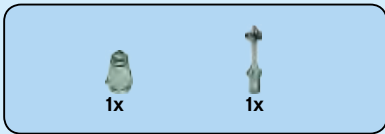

140



141

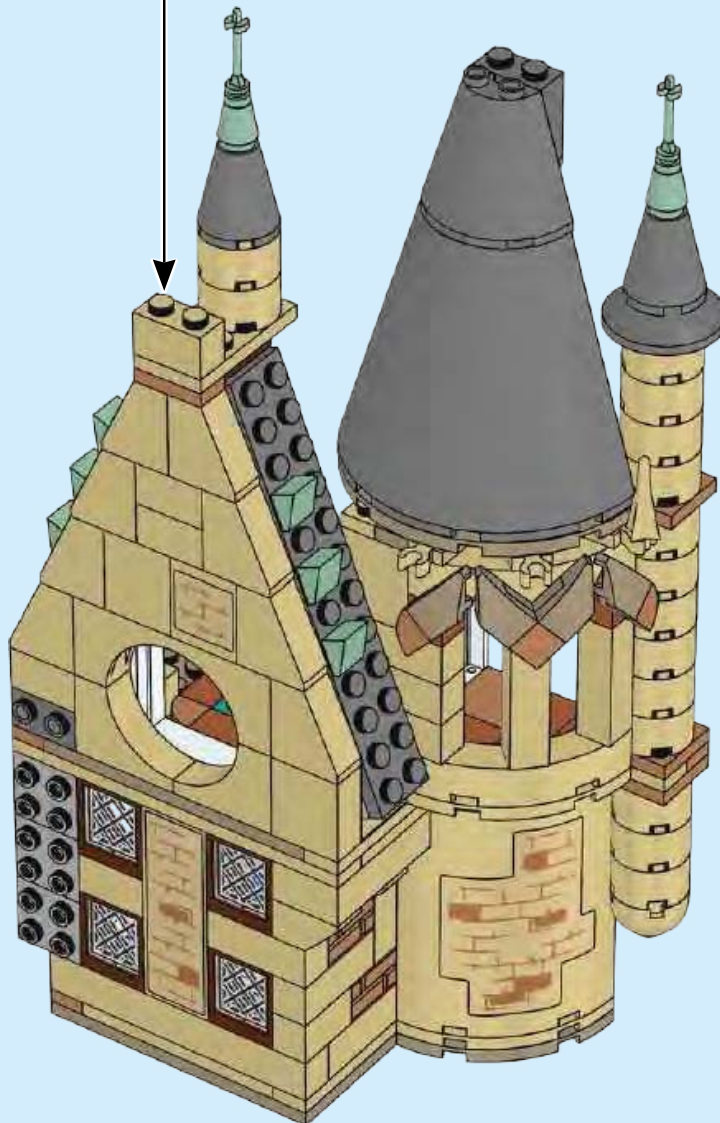



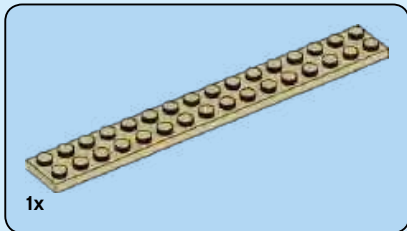
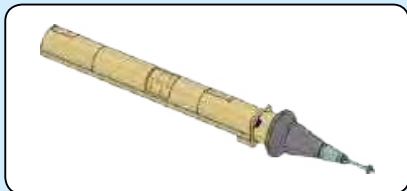

142

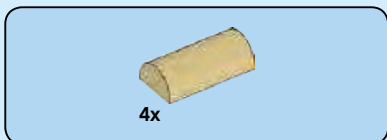
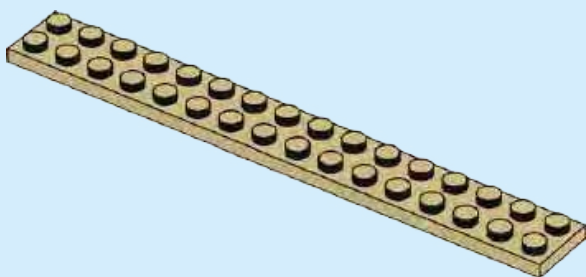

143

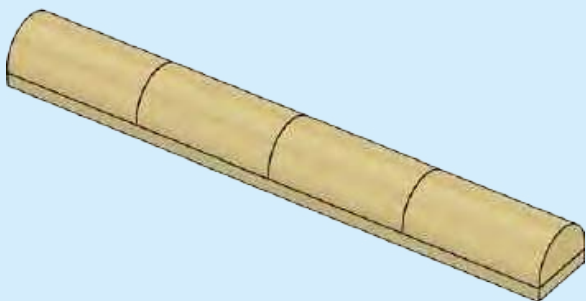

144

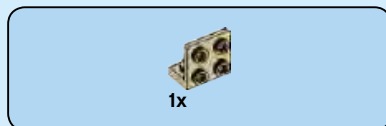
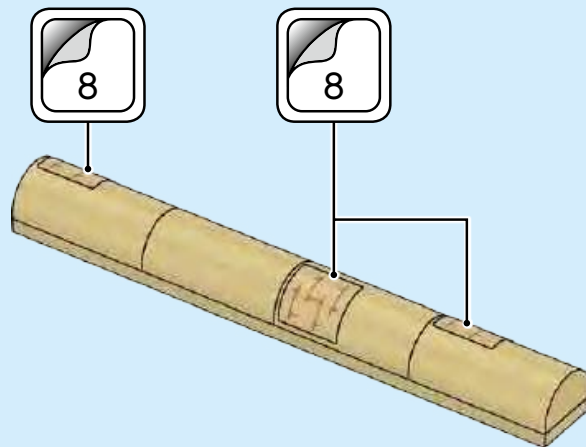

145

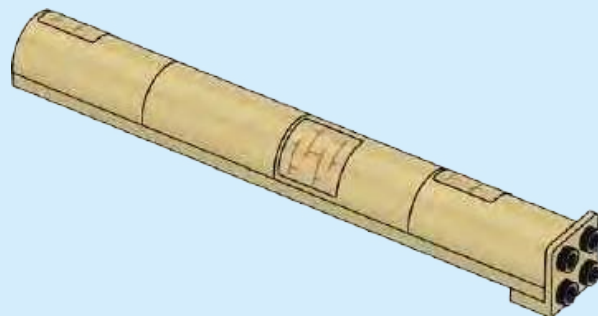

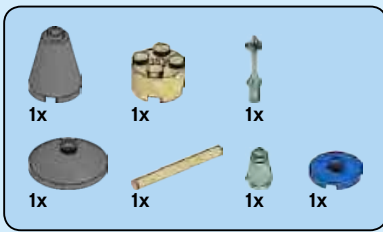

146

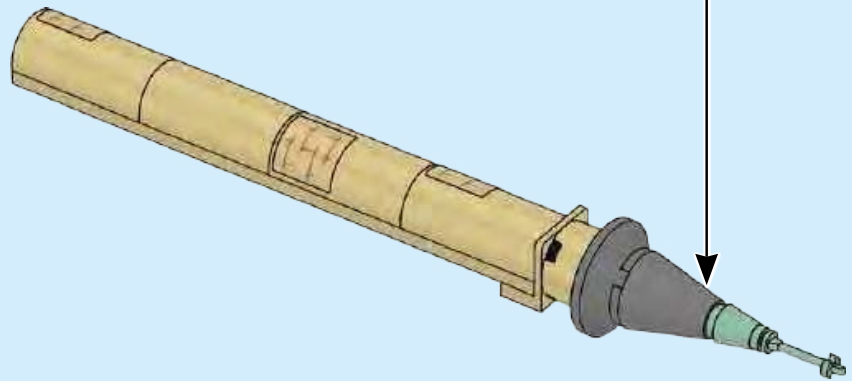
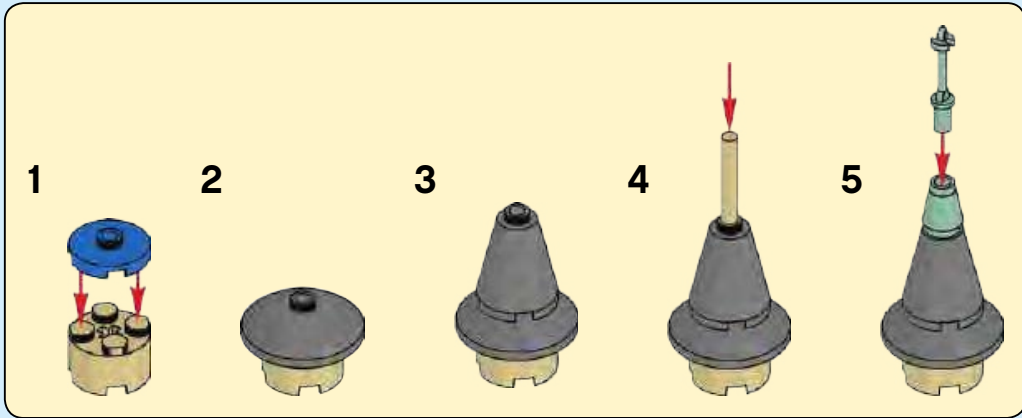

147



156

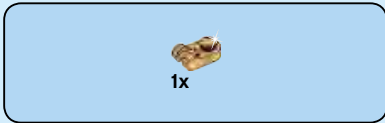
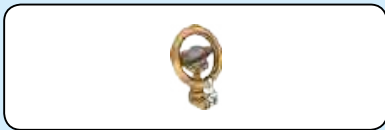

**148**

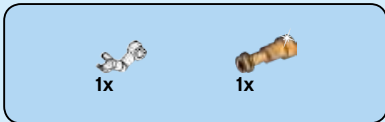

**149**

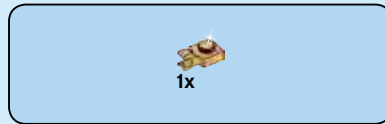

**150**

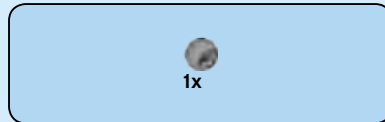

**151**



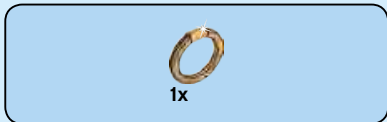

152



153



154



158



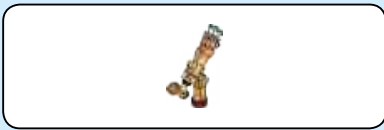

**155**

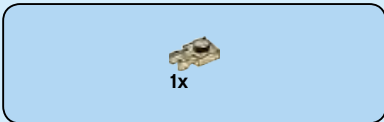

**156**

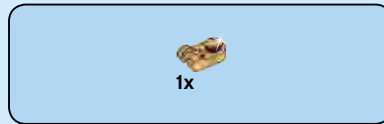

**157**

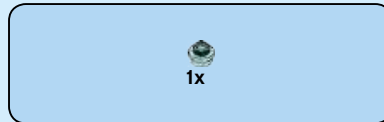

**158**





159



160



160



161

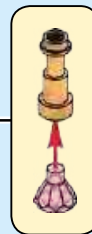

162

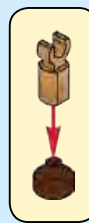

163

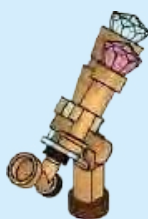

164





165

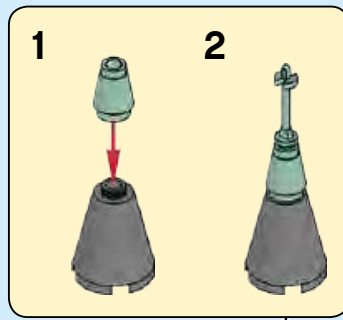

162

166

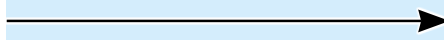



1



2









# Harry Potter



75948



75954



75953



75969

Limited availability  
Disponibilité limitée  
Disponibilidad limitada



Anglia is a trademark owned and licensed by Ford Motor Company.

WIZARDING WORLD characters, names and related indicia are © & ™ Warner Bros. Entertainment Inc. WB SHIELD: © & ™ WBEI Publishing Rights © JKR. (s20)





# Harry Potter

Limited availability  
Disponibilité limitée  
Disponibilidad limitada



75967



75969



75968



75966

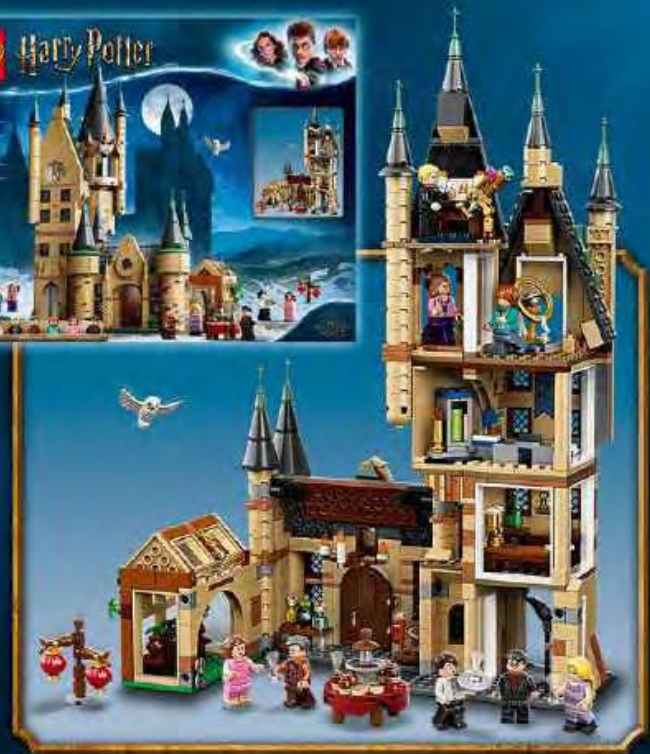

Anglia is a trademark owned and licensed by Ford Motor Company.

WIZARDING WORLD characters, names and related indicia are © & ™ Warner Bros. Entertainment Inc. WB SHIELD: © & ™ WBEI. Publishing Rights © JKR. (s20)



1x 6234807  
 1x 6186642  
 2x 6186681  
 1x 6146086  
 4x 6057414  
 2x 6299836  
 8x 6218823  
 1x 306801  
 1x 6306689  
 4x 6262945  
 1x 6299912  
 3x 6256127  
 7x 6269968  
 3x 6287774  
 3x 6285621  
 4x 4529237  
 6x 4161734  
 7x 4516055

3x 6178916  
 2x 4159553  
 22x 4113915  
 2x 6057517  
 4x 6029889  
 7x 4624086  
 1x 6191654  
 32x 4125220  
 12x 4626200  
 5x 4159279  
 36x 4109995  
 1x 6024495  
 4x 4578107  
 4x 6046922  
 2x 4159196  
 2x 4273526  
 8x 4114026  
 1x 4129996

3x 4114064  
 2x 6174925  
 12x 6046924  
 1x 6236629  
 4x 4114084  
 1x 6173057  
 5x 4114306  
 4x 6226565  
 6x 6055868  
 4x 4118866  
 7x 4124455  
 6x 4121921  
 1x 6252199  
 19x 4162465  
 4x 6287878  
 2x 6212038  
 2x 6058090  
 2x 6058093

2x 6116614  
 4x 6232142  
 2x 6213676  
 1x 4550323  
 5x 4113233  
 4x 4666611  
 2x 4578109  
 4x 6294592  
 5x 4114309  
 4x 6306069  
 1x 4114319  
 3x 6075057  
 6x 4124067  
 7x 4112982  
 2x 6106187

1x 4570516  
 2x 6006805  
 1x 6034852  
 1x 6056230  
 1x 6079724  
 6x 4159774  
 1x 6123812  
 1x 4143409  
 1x 6156462  
 1x 6030980  
 2x 6293279  
 1x 6129995  
 1x 6034719  
 4x 6194417  
 2x 302223  
 2x 6196596

4x 614126  
 10x 6234994  
 1x 6173105  
 1x 4526110  
 1x 6104209  
 2x 4278359  
 1x 6271535  
 2x 403226  
 7x 4121715  
 1x 9339  
 2x 6308975  
 1x 6266244  
 4x 6016172  
 2x 6061032  
 1x 6268854  
 7x 6235080  
 7x 6182261  
 1x 4541414

|               |                |               |                |               |                |
|---------------|----------------|---------------|----------------|---------------|----------------|
| 2x<br>6247798 | 1x<br>6270030  | 8x<br>6233298 | 3x<br>6080355  | 2x<br>6196221 | 2x<br>6214808  |
| 5x<br>6186867 | 3x<br>4666322  | 8x<br>6134280 | 6x<br>4211183  | 3x<br>6167644 | 2x<br>4667595  |
| 4x<br>6166107 | 15x<br>6254484 | 6x<br>4652205 | 2x<br>4529242  | 1x<br>4211206 | 1x<br>4529241  |
| 4x<br>6254552 | 6x<br>6186012  | 2x<br>6223225 | 1x<br>6186673  | 2x<br>4216668 | 2x<br>6225242  |
| 4x<br>6278710 | 1x<br>6093518  | 5x<br>4616578 | 6x<br>6275030  | 2x<br>4212225 | 10x<br>4211535 |
| 4x<br>6244904 | 2x<br>4579659  | 2x<br>6186826 | 2x<br>6270028  | 2x<br>4211225 | 6x<br>6078985  |
| 4x<br>6244904 | 6x<br>4614158  | 4x<br>6069257 | 1x<br>6062574  | 2x<br>4538252 | 2x<br>6183782  |
| 1x<br>6253231 | 4x<br>6092602  | 2x<br>6075626 | 1x<br>4624507  | 1x<br>4538252 | 1x<br>4540203  |
| 8x<br>6246888 | 1x<br>4570877  | 2x<br>6146199 | 1x<br>6174229  | 3x<br>4211186 | 5x<br>4211398  |
| 1x<br>6247362 | 2x<br>6186423  | 4x<br>6198037 | 1x<br>6167879  | 1x<br>6070442 | 4x<br>6146223  |
| 2x<br>6253734 | 4x<br>6198037  | 5x<br>6074892 | 4x<br>6160180  | 1x<br>4211247 | 2x<br>4211440  |
| 1x<br>6276023 | 1x<br>6000743  | 1x<br>6293265 | 1x<br>4506003  | 1x<br>4211211 | 2x<br>4585429  |
| 1x<br>6284030 | 1x<br>6293265  | 4x<br>6249417 | 2x<br>4660435  | 1x<br>6055145 | 10x<br>4211414 |
| 1x<br>6247792 | 1x<br>6249417  | 1x<br>6254100 | 6x<br>4211180  | 1x<br>4225715 | 3x<br>6123809  |
| 1x<br>6173640 | 1x<br>6061678  | 1x<br>6061678 | 2x<br>6078605  | 4x<br>6219658 | 2x<br>4211397  |
| 1x<br>6168667 | 1x<br>6258352  | 2x<br>4570451 | 1x<br>4542131  | 4x<br>6219657 | 1x<br>6070564  |
| 1x<br>6238674 | 1x<br>6258352  | 1x<br>6146989 | 4x<br>6064188  | 4x<br>4539097 | 1x<br>4211396  |
| 1x<br>6247364 | 1x<br>6258353  | 1x<br>4246957 | 1x<br>6058084  | 4x<br>6208726 | 1x<br>6102769  |
| 4x<br>6236437 | 1x<br>6268818  | 3x<br>4570111 | 10x<br>4595814 | 1x<br>6208726 | 1x<br>4560183  |
| 1x<br>6270031 | 1x<br>6247796  |               | 1x<br>4252456  |               | 2x<br>4211452  |
| 2x<br>6258951 | 1x<br>6023827  |               |                |               |                |

1x  
6305824

1x  
6076203

8x  
6092666

1x  
4210978

1x  
6230233

4x  
6013658

2x  
4210865

2x  
6201630

5x  
6235153

2x  
4528323

3x  
4560184

2x  
4211115

1x  
6232139

1x  
6133611

1x  
4211122

2x  
4211067

1x  
4210720

1x  
4654613

1x  
6309172

1x  
6305887

1x  
6278447

1x  
4586410

1x  
6299913

1x  
6124907

1x  
6192171

1x  
6305819

1x  
6299828

1x  
6266198

1x  
6265371

1x  
6258524

1x  
6299870

1x  
6306690

1x  
6305804

1x  
6305485

1x  
6305873

1x  
6306711

1x  
6305503

1x  
6306452

1x  
6299914

1x  
4267425

1x  
6320357

2x  
6262949

4x  
6299867

8x  
6057986

10x  
6215606

7x  
6248536

1x  
6177146

2x  
4569385

4x  
6167643

1x  
6311263

16x  
4656783

20x  
6218360

3x  
6167642

1x  
6102990

3x  
6056383

2x  
6252192

5x  
6177535

4x  
6102998

6x  
6167700

2x  
6167780

4x  
6213276

2x  
6270032

1x  
6306667

2x  
6134197

1x  
4529672

1x  
6254792

1x  
6051507

1x  
6082975

4x  
6251854

2x  
4616211

1x  
6107389

1x  
6096993

1x  
6076677

2x  
6153593

9x  
6058245

2x  
6273296

1x  
6290401

2x  
6224825

3x  
6078364

1x  
4529247

2x  
4523159

6x  
6190252

1x  
6173139

1x  
6146054

2x  
6071259

3x  
4523160

2x  
6212377

1x  
6286094

2x  
4538126

1x  
6232257

Customer Service

Kundenservice

Service Consommateurs

Servicio Al Consumidor

LEGO.com/service or dial

: 00800 5346 5555  
: 1-800-422-5346

# WIN

GO TO [WWW.LEGO.COM/PRODUCTFEEDBACK](http://WWW.LEGO.COM/PRODUCTFEEDBACK)  
AND GIVE US YOUR SHORT **FEEDBACK**  
ABOUT THIS LEGO® SET FOR A CHANCE  
TO WIN A COOL LEGO PRIZE.

Terms & Conditions apply



## LEGO.com/productfeedback

### GEWINNE

Erzähle uns auf  
[www.LEGO.com/productfeedback](http://www.LEGO.com/productfeedback)

etwas über die Erfahrungen, die du mit  
diesem LEGO® Set gemacht hast, und  
sichere dir die Chance auf einen coolen  
LEGO Preis!

Es gelten die Teilnahmebedingungen

### GAGNE

Rends-toi sur  
[www.LEGO.com/productfeedback](http://www.LEGO.com/productfeedback)

et donne-nous quelques commentaires  
sur ce produit LEGO® pour avoir une  
chance de gagner un prix LEGO !

Voir Conditions Générales

### GANAN

Visita  
[www.LEGO.com/productfeedback](http://www.LEGO.com/productfeedback)

y envíanos tu opinión acerca de este  
set LEGO®. ¡Participarás en el sorteo  
de un premio LEGO!

Términos y Condiciones aplicables

### 获取奖品

登录  
[www.LEGO.com/productfeedback](http://www.LEGO.com/productfeedback)

给出关于此乐高®套装的简短反馈，  
就有机会获得炫酷乐高奖品

《条款及条件》适用

### 경품 당첨 기회

[www.LEGO.com/productfeedback](http://www.LEGO.com/productfeedback)

페이지로 이동하여 이 레고® 세트에 대한  
간략한 피드백을 보내 주시고 멋진 레고  
경품을 탈 수 있는 기회도 잡으십시오

약관 적용

### ЗАПОЛНИ АНКЕТУ И ПОЛУЧИ ПРИЗ

Перейди по ссылке  
[www.LEGO.com/productfeedback](http://www.LEGO.com/productfeedback)

ответь всего на несколько вопросов  
об этом наборе LEGO®, и у тебя по-  
явится шанс выиграть замечательный  
приз от компании LEGO.

Применяются Условия и правила  
участия



LEGO and the LEGO logo are trademarks of the/son des marques de commerce du/son marcas registradas de LEGO Group.  
©2020 The LEGO Group.  
WIZARDING WORLD characters, names and related indicia are © & ™ Warner Bros. Entertainment Inc.  
WB SHIELD: © & ™ WBEI. Publishing Rights © JKR. (s20)

6325886