

| A | B        | C    | D       |
|---|----------|------|---------|
| 1 | S205 046 | 2071 | 596 2/2 |
| 2 | S205 163 | 2043 | 390 1/2 |
| 3 | S205 164 | 2043 | 390 1/2 |
| 4 | S205 203 | 600  | 390 1/2 |
| 5 | S205 204 | 600  | 390 1/2 |
| 6 | S205 330 | 567  | 360 1/2 |
| 7 | S205 587 | 445  | 100 1/2 |
| 8 | S205 990 | 2053 | 288 1/2 |
| 9 | Lh 2035  | 2035 | 14 1/2  |

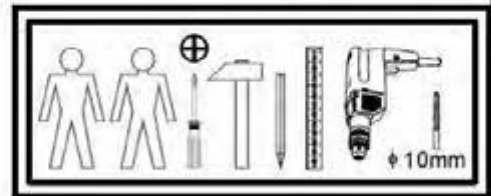

|                 |                          |                             |                             |                             |                                |                |               |                       |
|-----------------|--------------------------|-----------------------------|-----------------------------|-----------------------------|--------------------------------|----------------|---------------|-----------------------|
| 4x<br><br>a102  | 4x<br><br>b59            | 4x<br><br>e1<br>ø7x90 mm    | 16x<br><br>f1<br>ø900 mm    | 2x<br><br>k84               | 2x<br><br>k85                  | 12x<br><br>l1  | 20x<br><br>l2 | 1x<br><br>m6<br>L-300 |
| 1x<br><br>n2611 | 4x<br><br>p6<br>ø4x35 mm | 4x<br><br>p27<br>ø3.5x13 mm | 8x<br><br>p51<br>ø3.5x15 mm | 7x<br><br>p38<br>ø3.5x15 mm | 16x<br><br>r1<br>ø15x12 mm ø14 | 16x<br><br>r42 | 16x<br><br>s2 | 8x<br><br>s4          |
| 4x<br><br>s33   | 8x<br><br>s59            | 1x<br><br>z1                | 1x<br><br>p17<br>ø2x11 mm   | 1x<br><br>r35<br>ø10x12 mm  |                                |                |               |                       |

S2 1

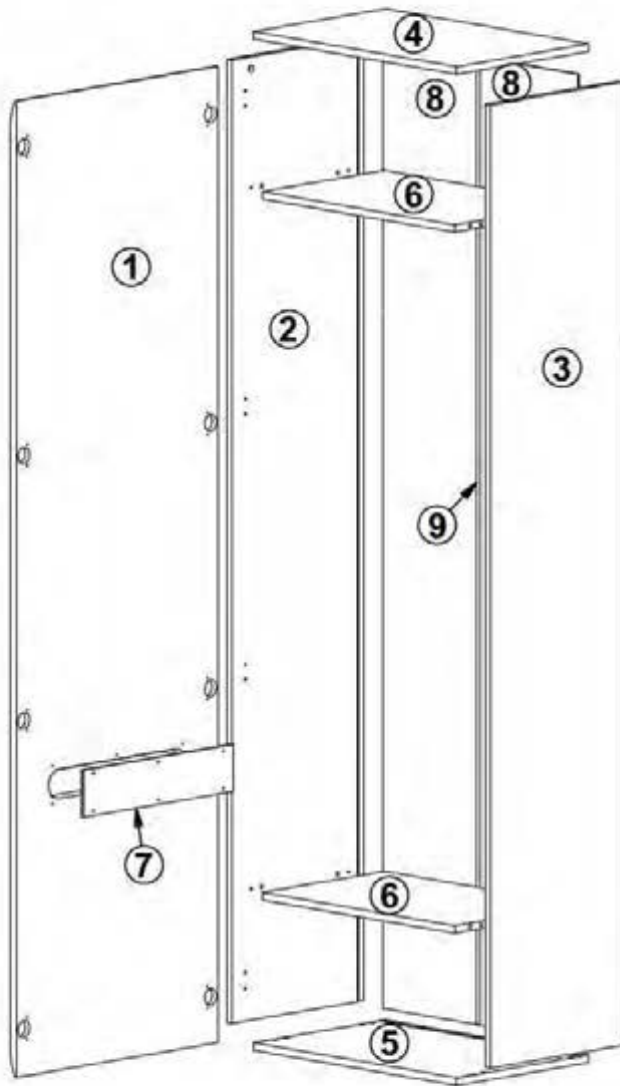
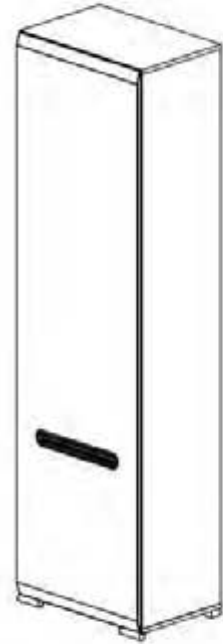
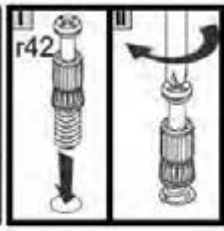
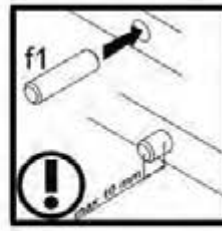
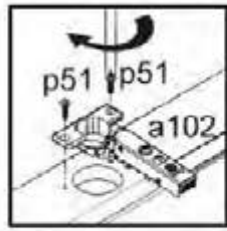
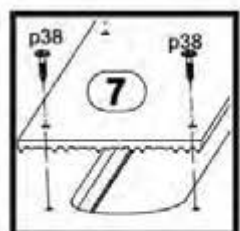
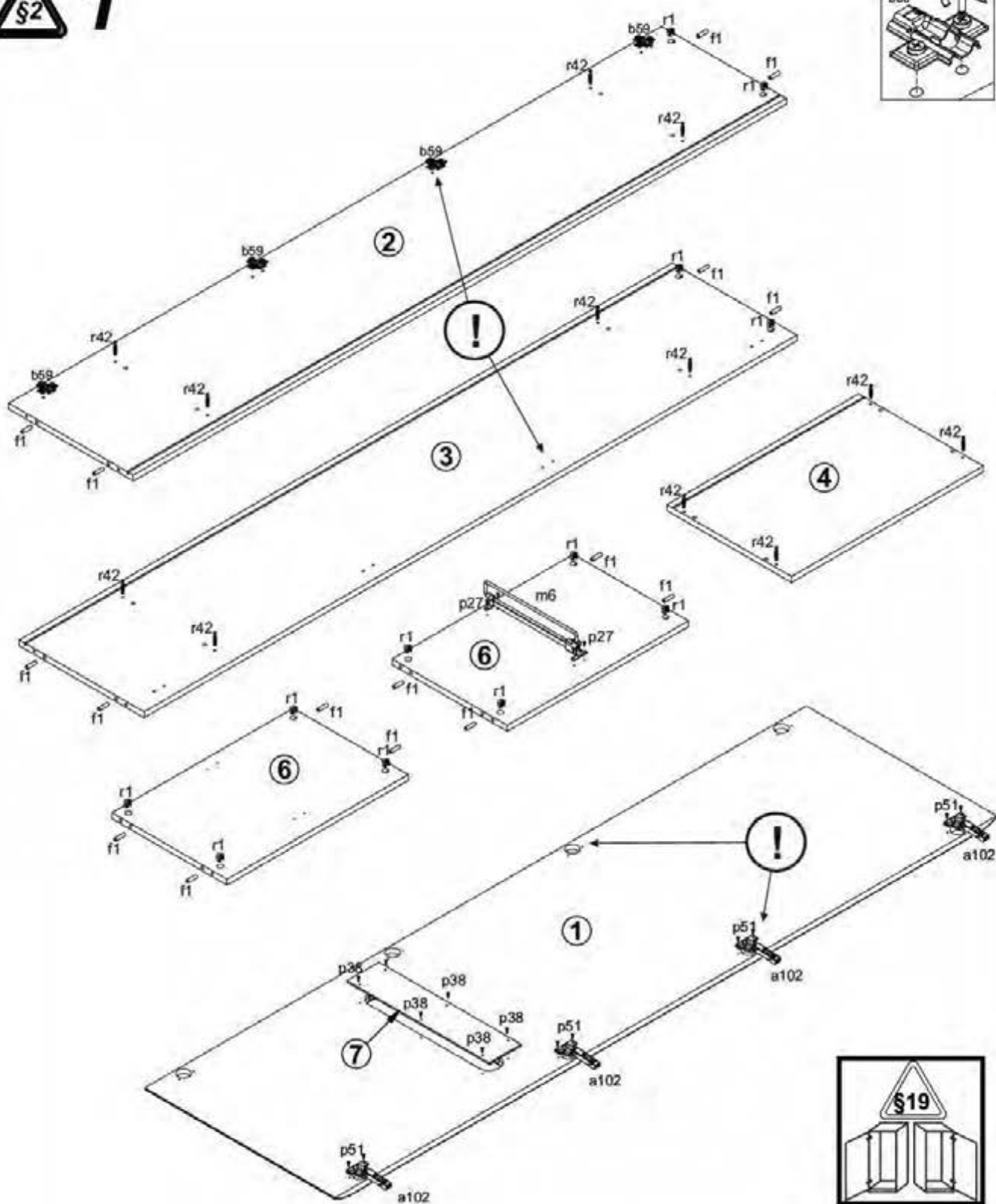
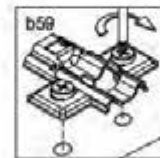

# 2

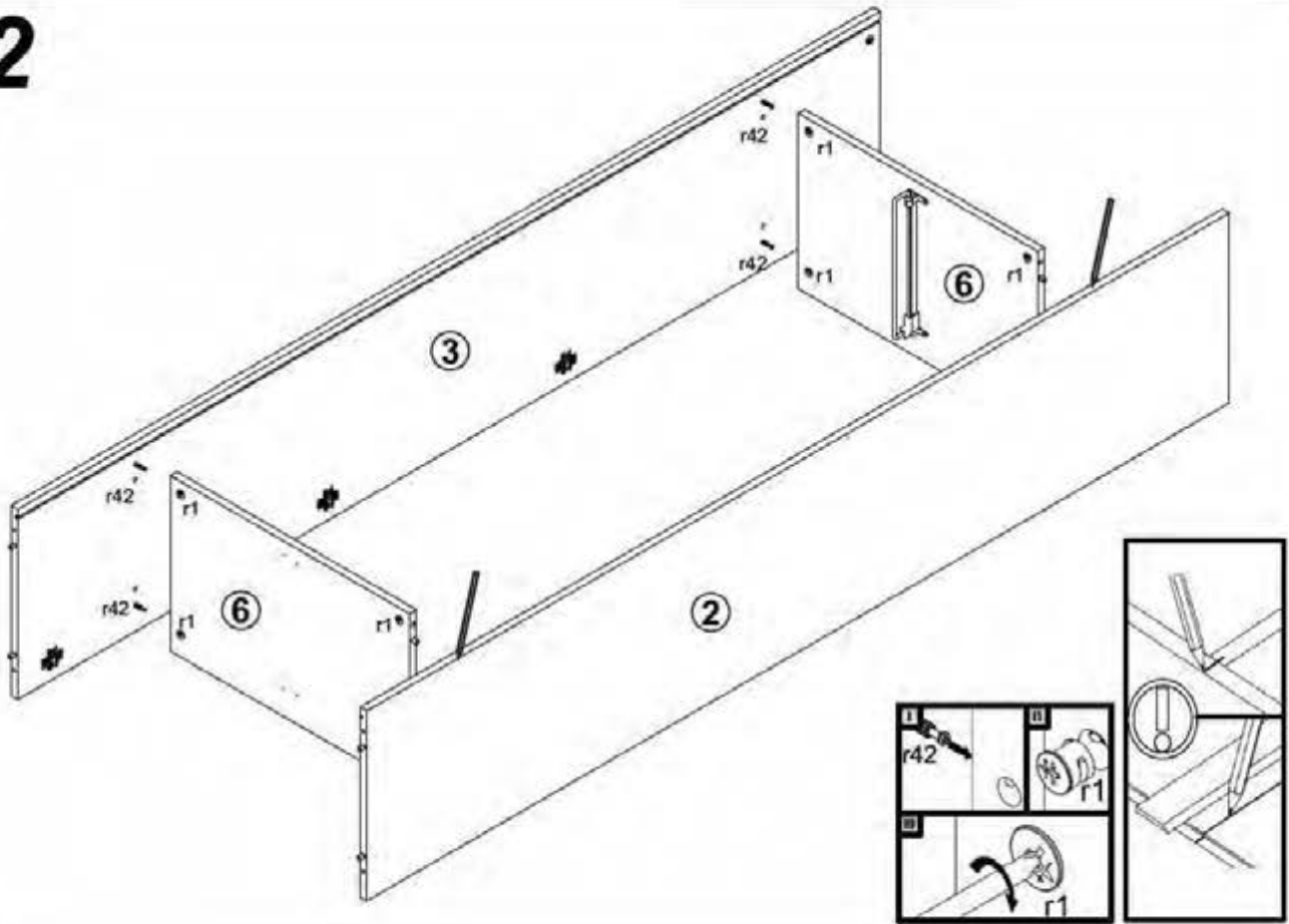

# 3

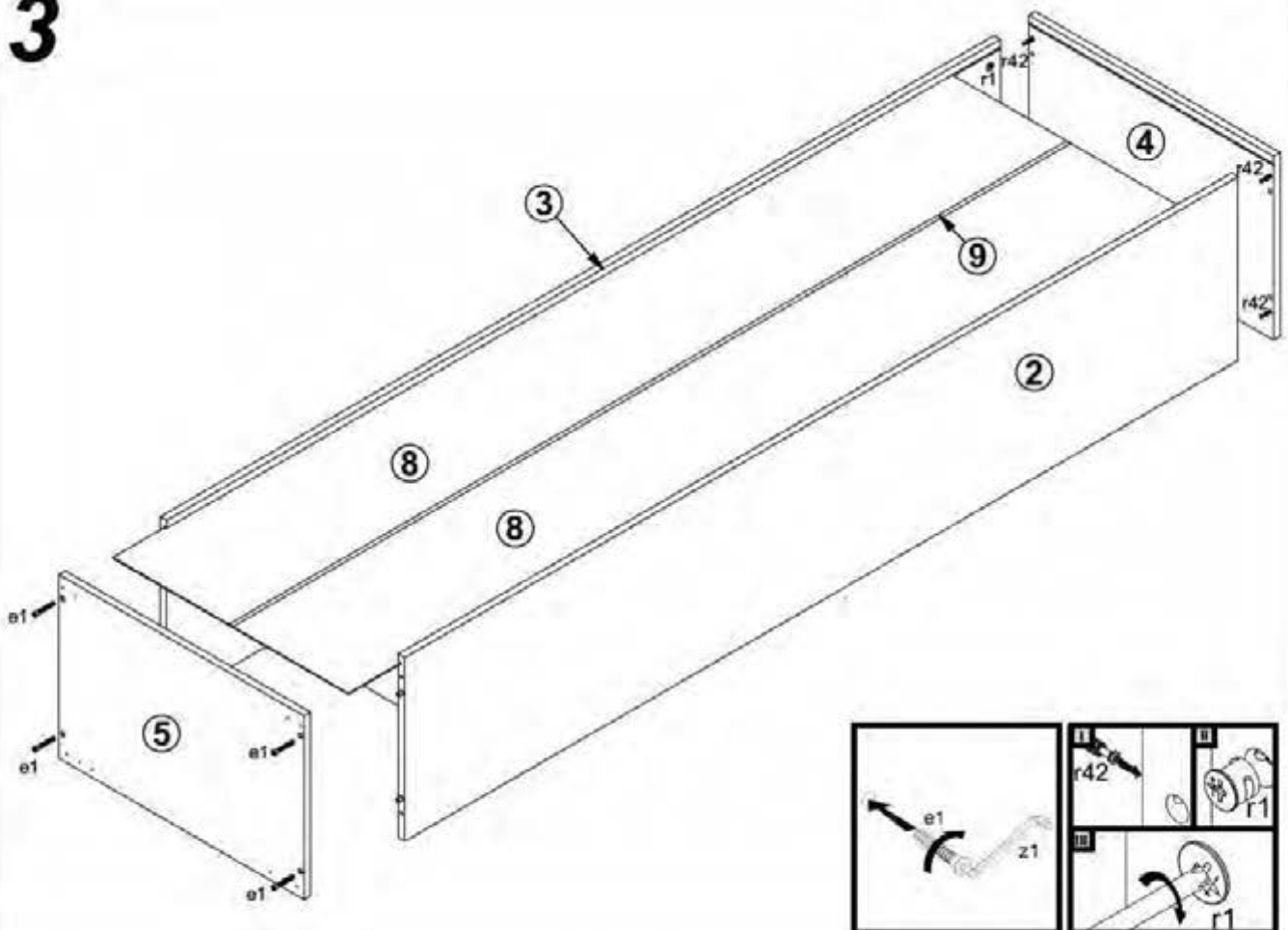

# 4

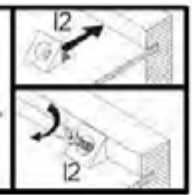
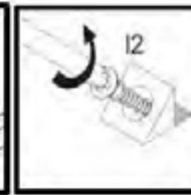
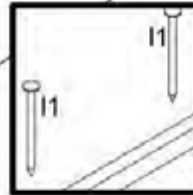
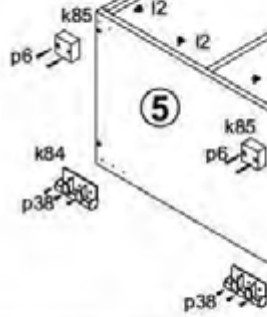
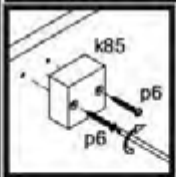
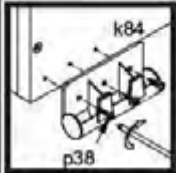
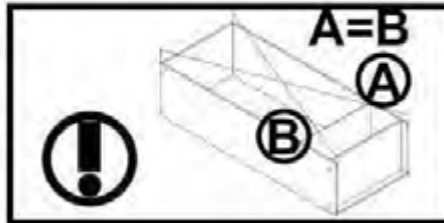
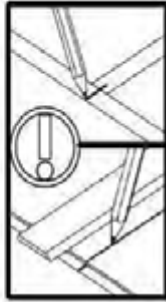

# 5

