

n 5 mm
10mm

A	B	C (mm)		D
1	S205 111	1001	330	1/5
2	S205 112	1001	330	1/5
3	S205 209	600	330	1/5
4	S205 302	567	300	1/5
5	S205 303	560	280	3/5
6	S205 551	563	469	4/5
7	S205 582	345	100	1/5
8	S205 701	403	596	5/5
9	S205 702	200	596	5/5
10	S205 311	567	330	1/5
11	S205 953	994	288	1/5
12	S205 954	994	288	1/5
13	Lh 977	977	14	1/5
14	qc33/1			5/5

60 min

3x a102	3x b59	4x d33	6x e47 ø16 mm	16x f1 ø10.2 mm	2x f35 ø19.6 mm	15x l1	12x l2	1x n165L	1x n165P	6x o54 ø13.98 xø11.5 mm	4x p9 ø4x30 mm	4x p38 ø3.5x15 mm
6x p51 ø3.8x15 mm	2x p127 ø6.0 mm	16x r1 ø15x12 mm, #10	16x r42	16x s2 ø16	6x s4 ø6	3x s33 ø30 mm	6x s59 ø12x0.5 mm					

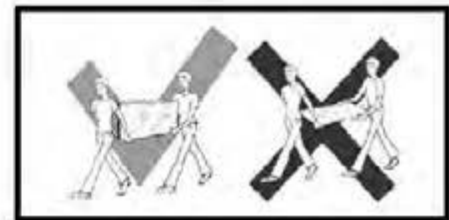
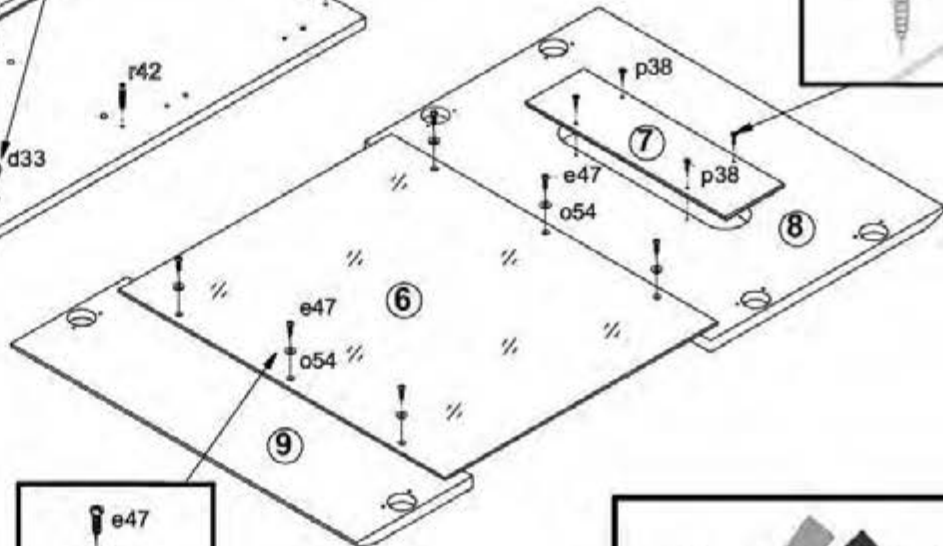
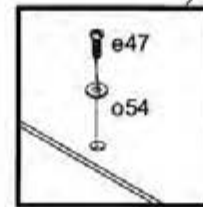
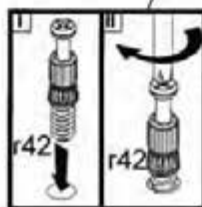
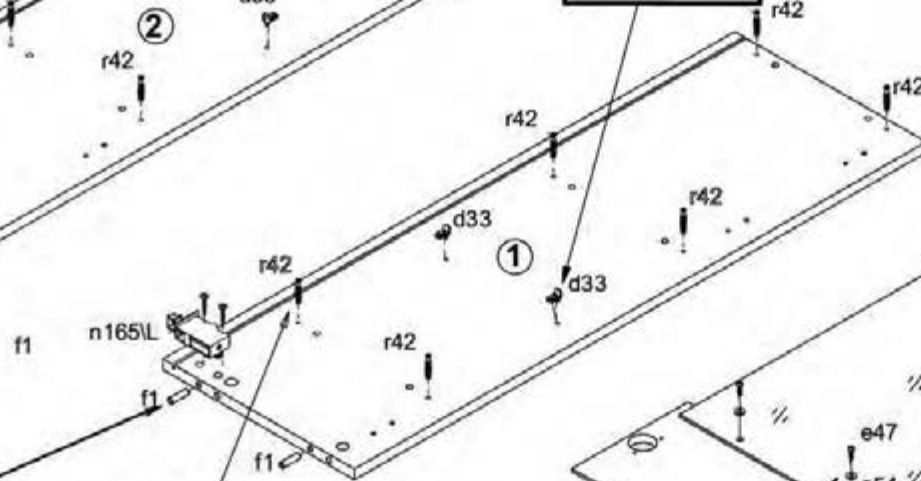
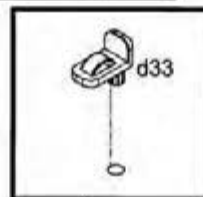
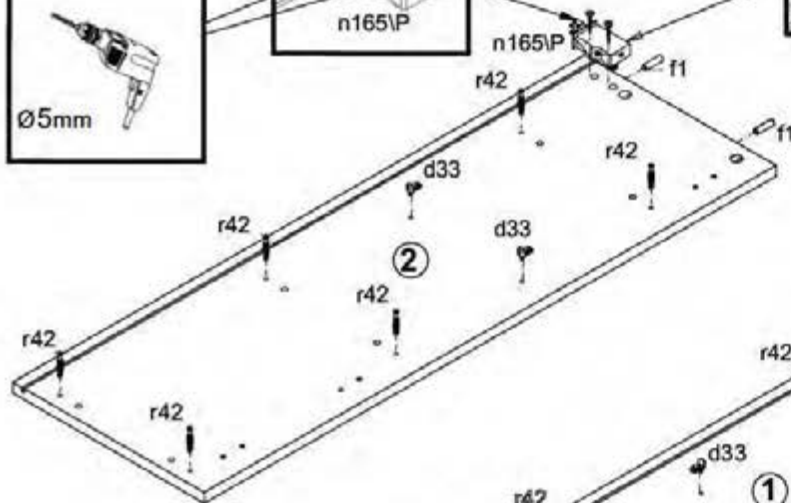
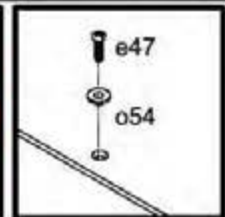
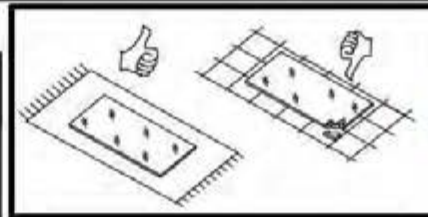
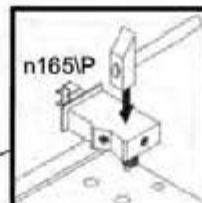
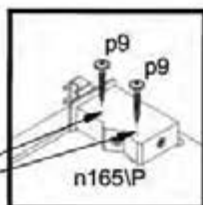

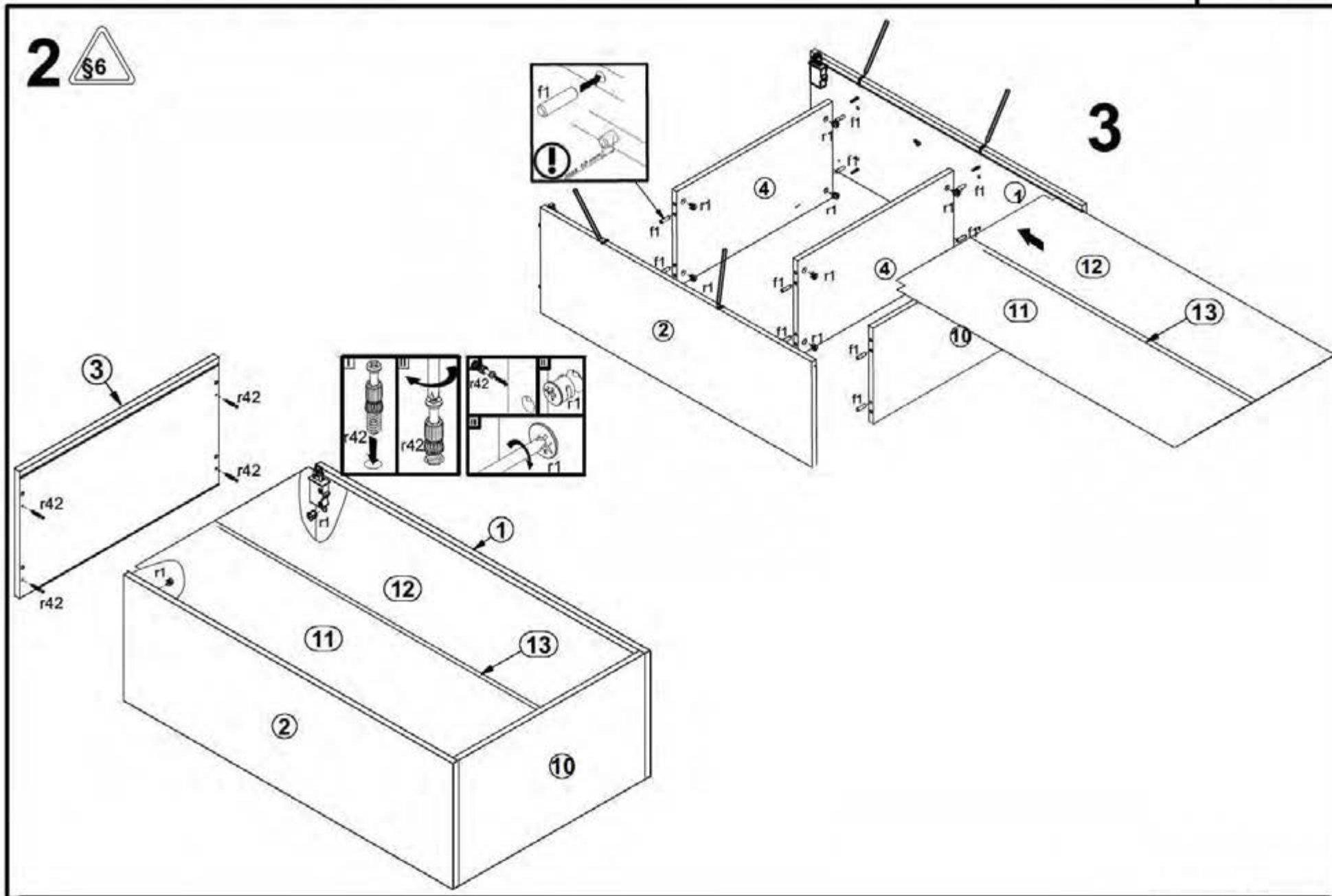

4

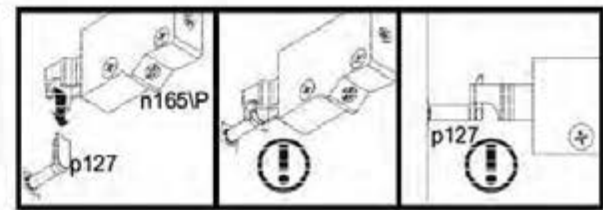
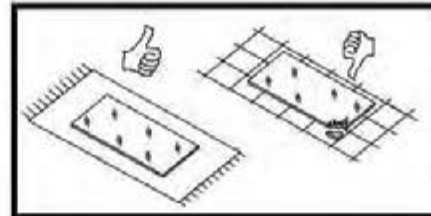
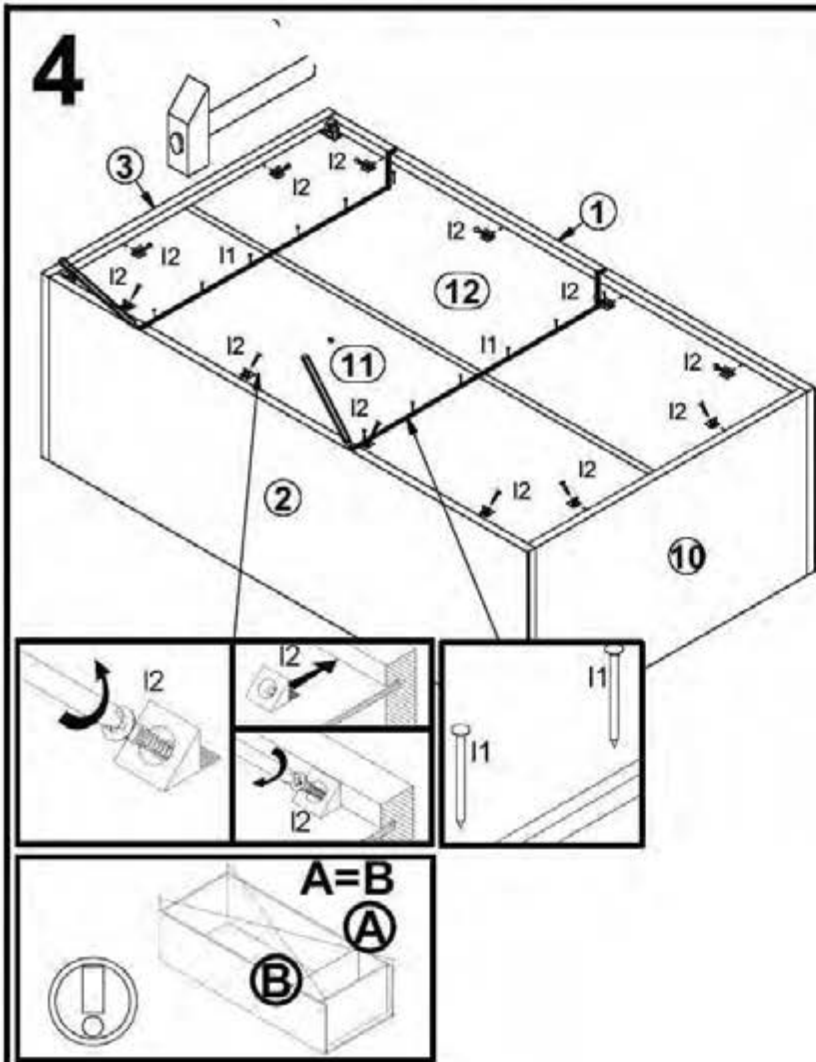

5

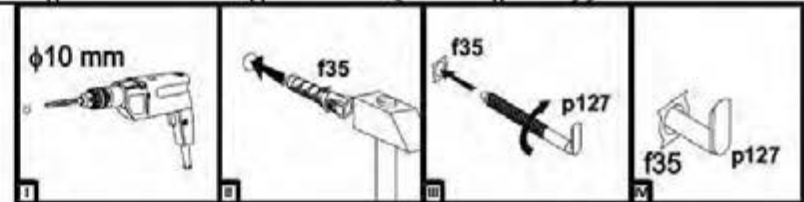
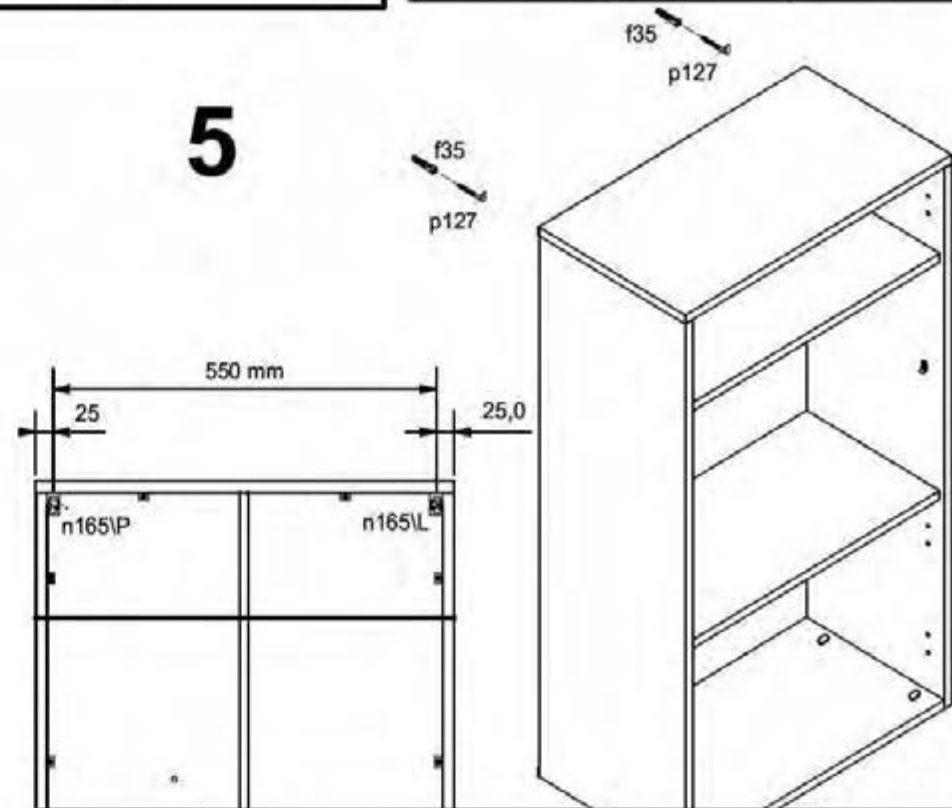

6

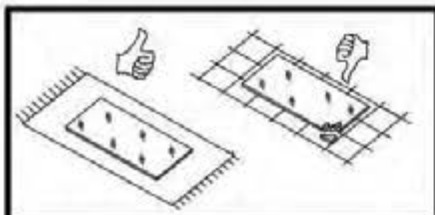
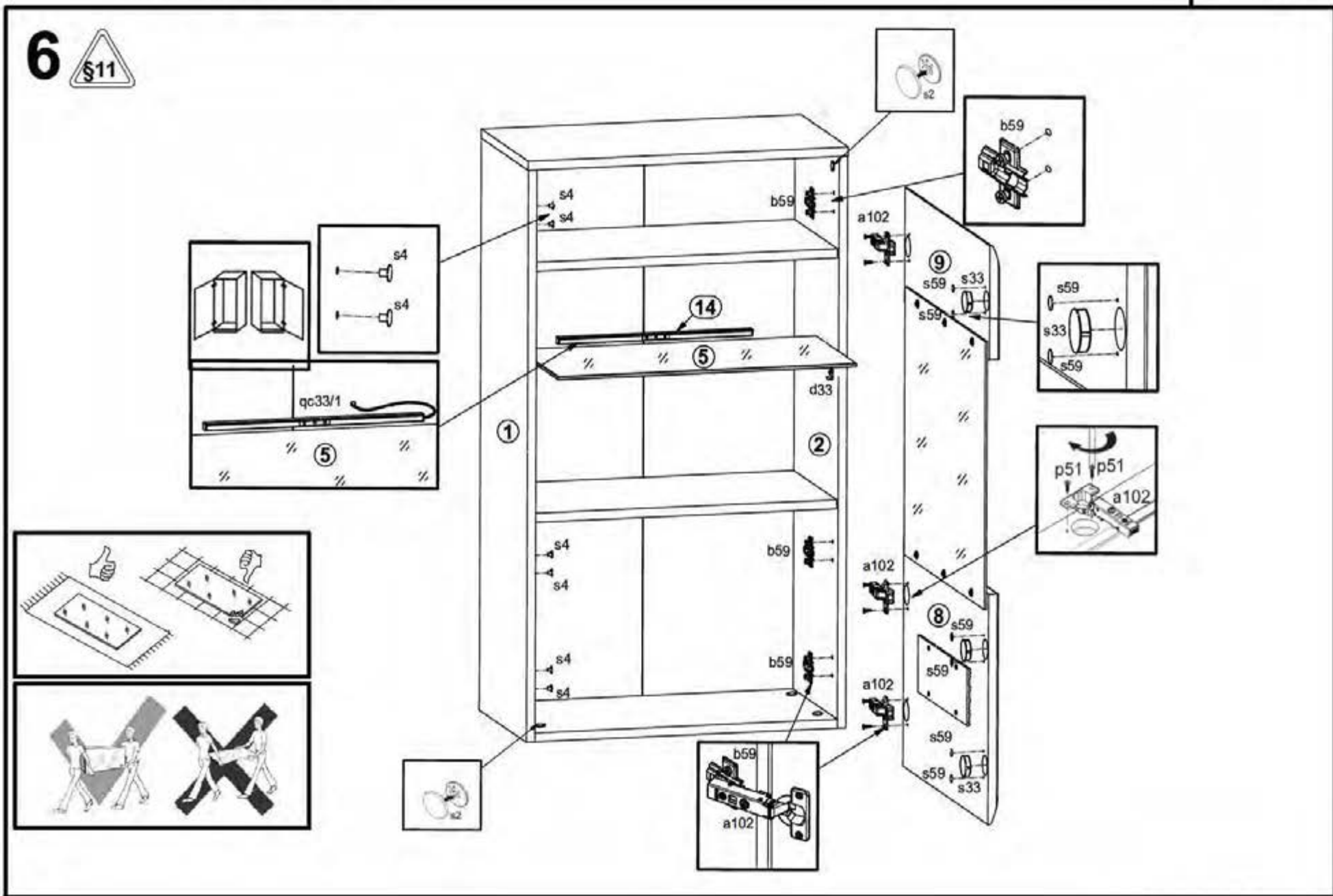

7

