

A	B	C	D	
1	S320-4407	1042	496	1/2
2	S320-525	584	80	2/2
3	S320-526	64	80	2/2
4	S320-527	64	80	2/2

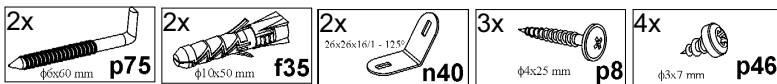

1

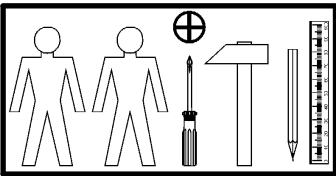
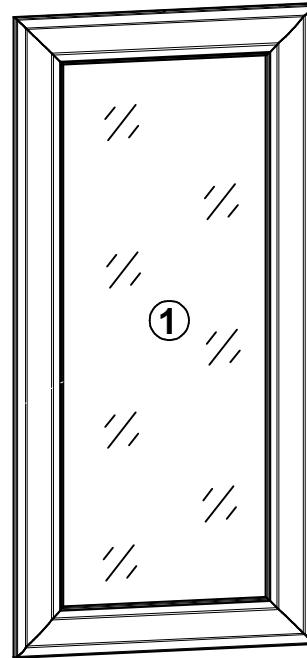
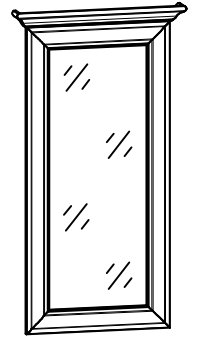
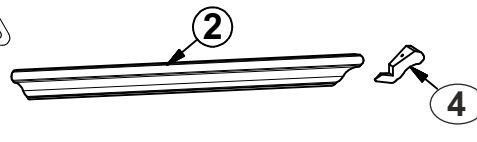
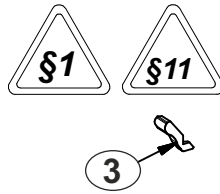
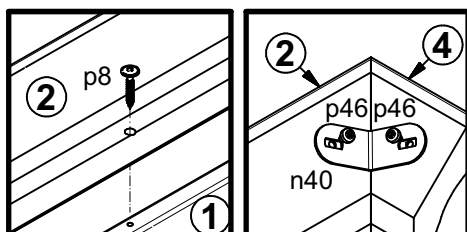
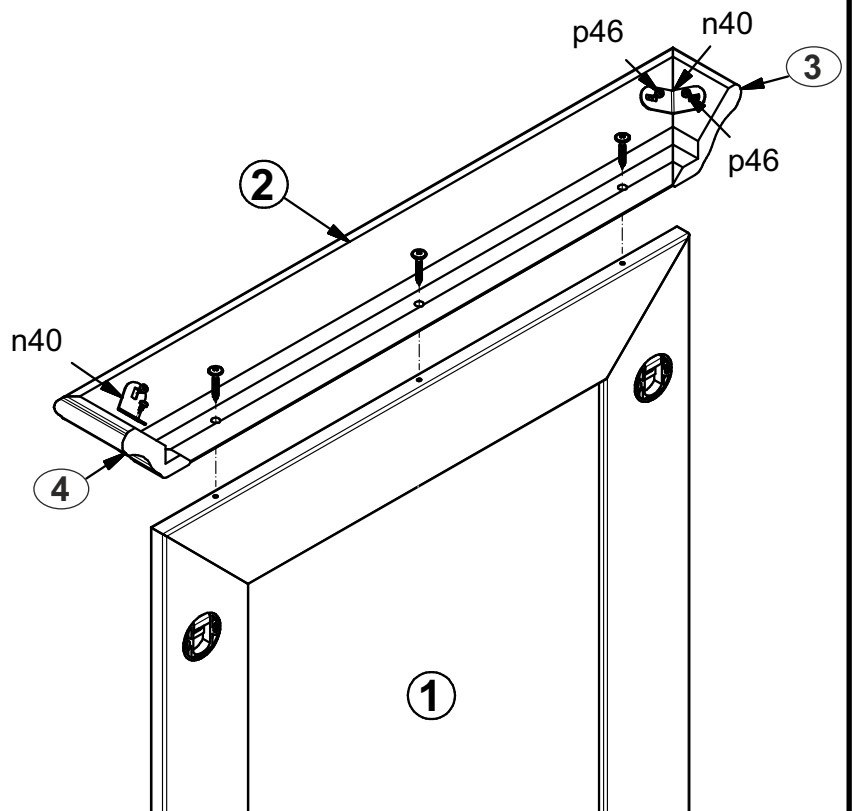

2 §11

