

A	B	C	D	A	B	C	D		
1	S322 0009	396	160	3/3	13	S322 3306	1200	381	2/3
2	S322 0010	396	160	3/3	14	S322 3307	786	356	2/3
3	S322 0011	396	160	3/3	15	S322 3308	396	356	2/3
4	S322 0012	640	396	3/3	16	S322 4408	1200	60	2/3
5	S322 0013	640	396	3/3	17	S322 9912	349	355	2/3
6	S322 0034	640	396	3/3	18	S322 9916	869	404	2/3
7	S322 1111	912	384	1/3	19	S322 9915	370	355	2/3
8	S322 1112	912	384	1/3	20	S322 9916	869	418	2/3
9	S322 1113	666	363	1/3	21	ZB 5504	317	120	1/3
10	S322 1114	168	352	1/3	22	ZB 5505	340	120	1/3
11	S322 1115	168	352	1/3	23	BB 501	350	120	1/3
12	S322 2205	1284	395	2/3	24	BB 502	350	120	1/3
					25	Lh 830	830	14	2/3

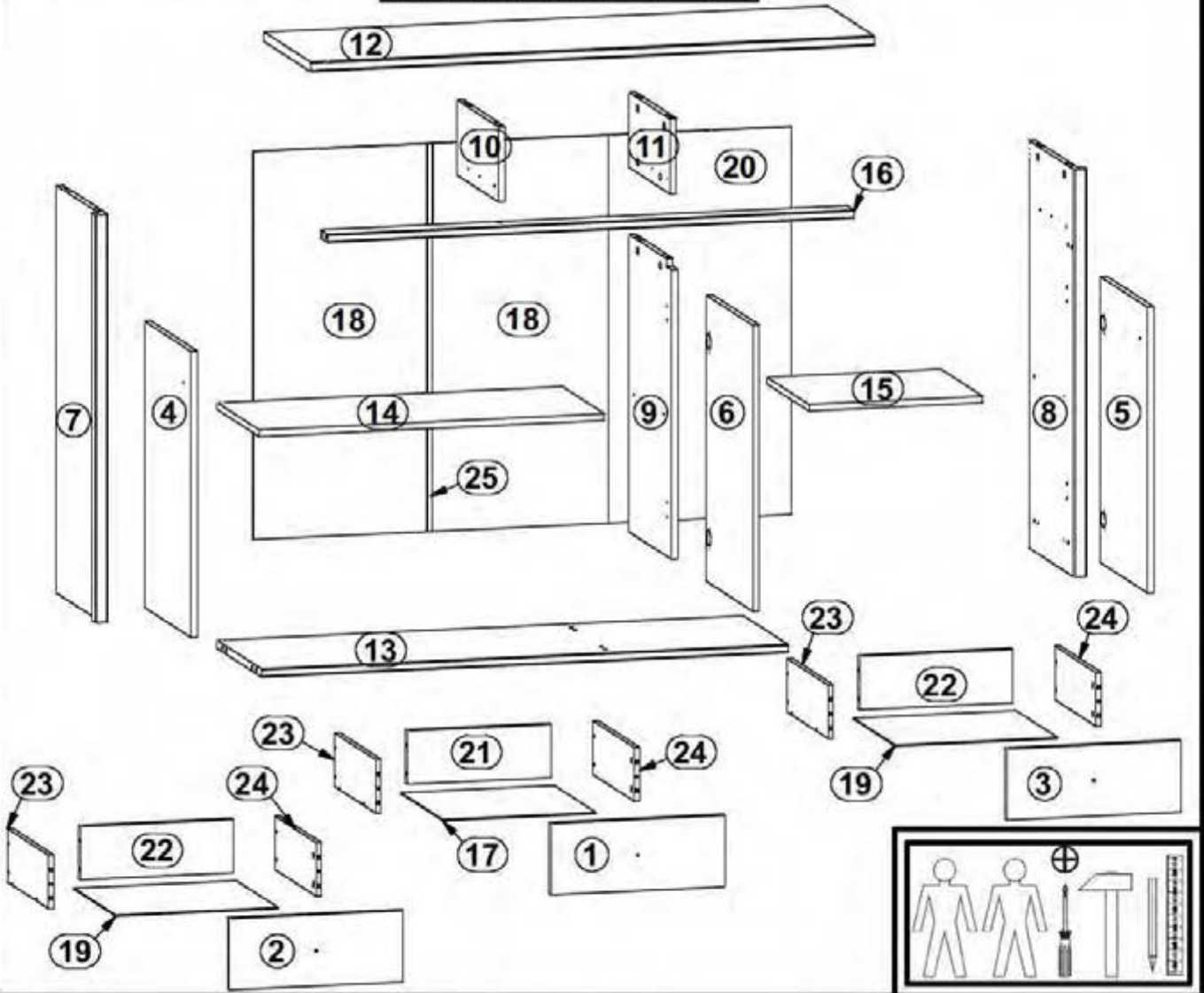

4x a43	2x a44	6x b19	5x c415	8x d1 Ø5x17 mm	2x d4 Ø6.3x15 mm	3x e1 Ø7x50 mm	1x e2 Ø6.3x13 mm	12x e3 Ø6x13 mm
12x e19 Ø5.6 mm	26x f1 Ø8x30 mm	12x f25 Ø6.5x40 mm	5x j1 M4x20 mm	4x k1	1x k38\13 Ø1.4x19 mm	1x k38\8	65x l1	13x p38 Ø3.6x16 mm
12x p51 Ø3.5x15 mm	6x p54 Ø3x12 mm	28x r1 Ø1.5x12 mm Ø10	24x r42 2x11	2x r51 Ø3 mm	3x w45\CL 350 mm	3x w45\CR 350 mm	3x w45\DL 350 mm	3x w45\DR 350 mm
1x p38 Ø3.6x16 mm	1x z1	1x n26\1	2x s2					

1 

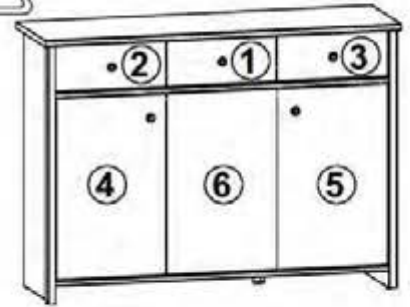
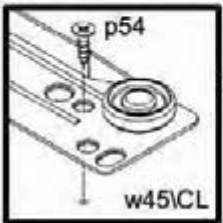
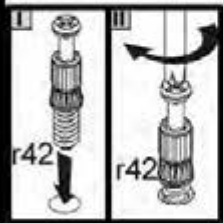
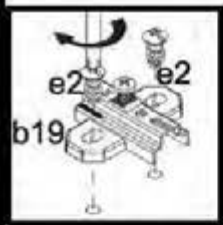
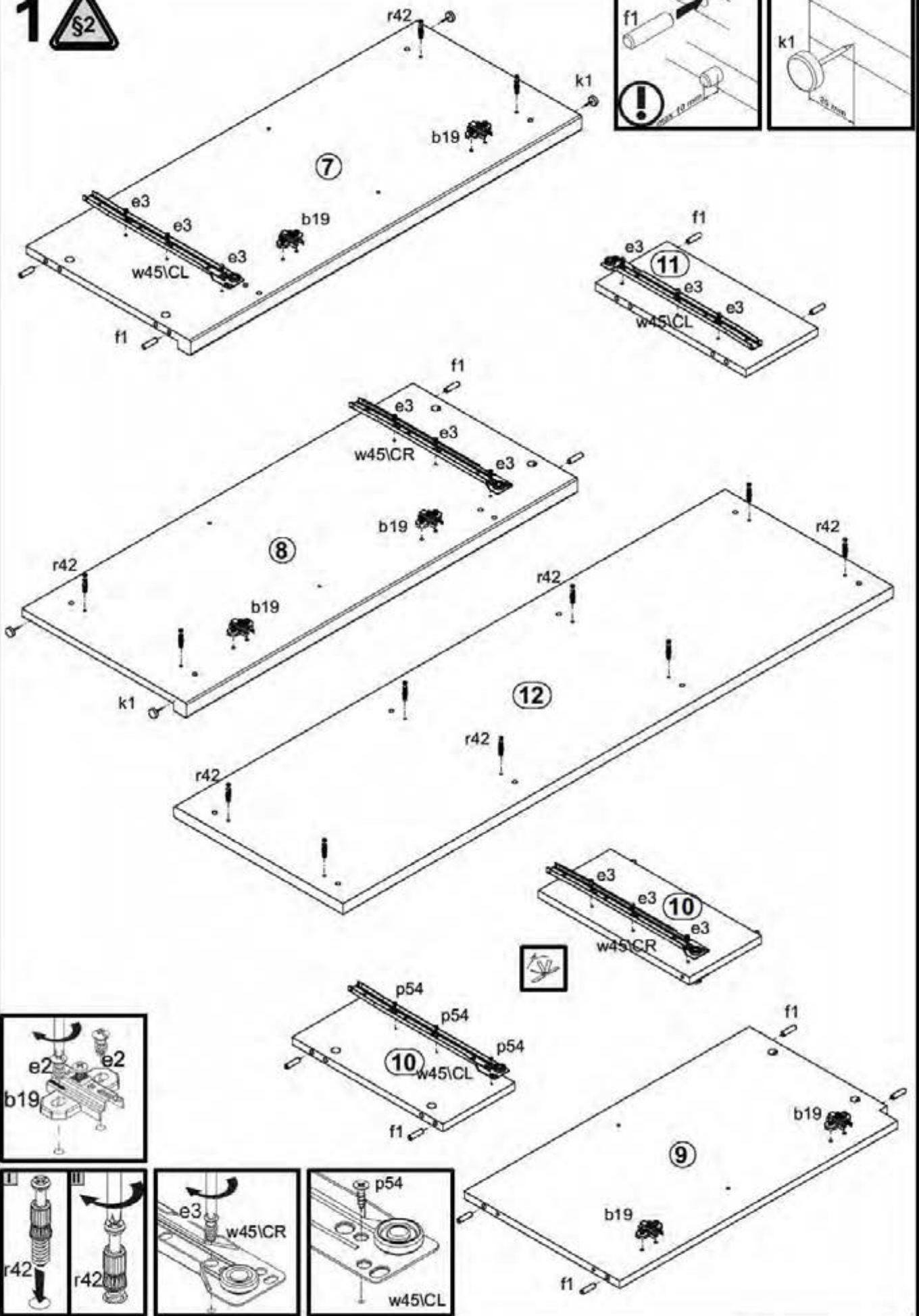
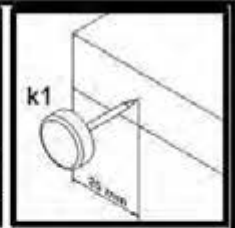
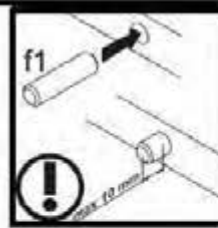

2

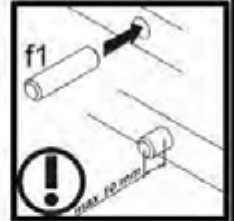
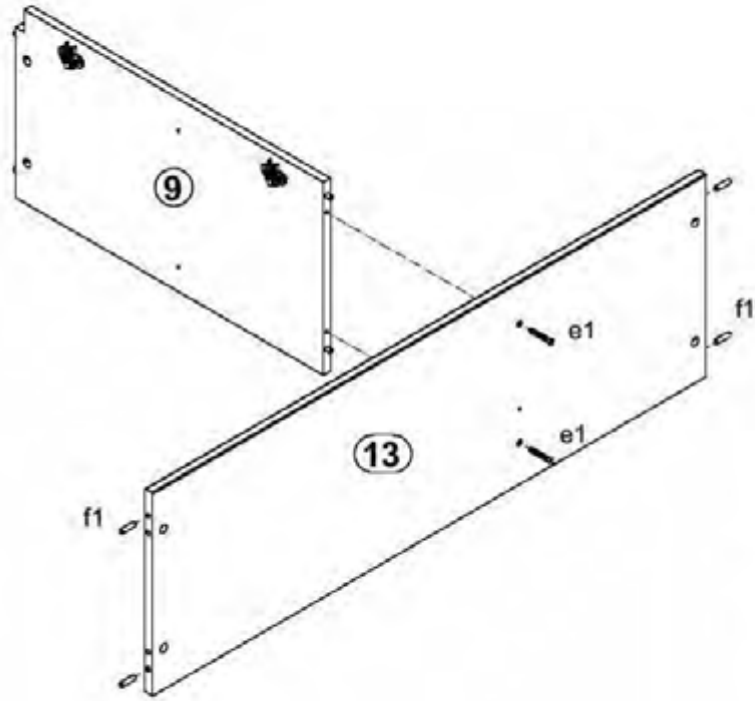

3

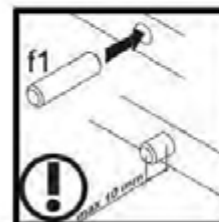
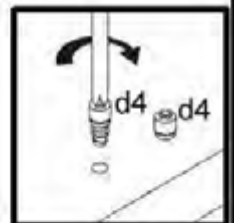
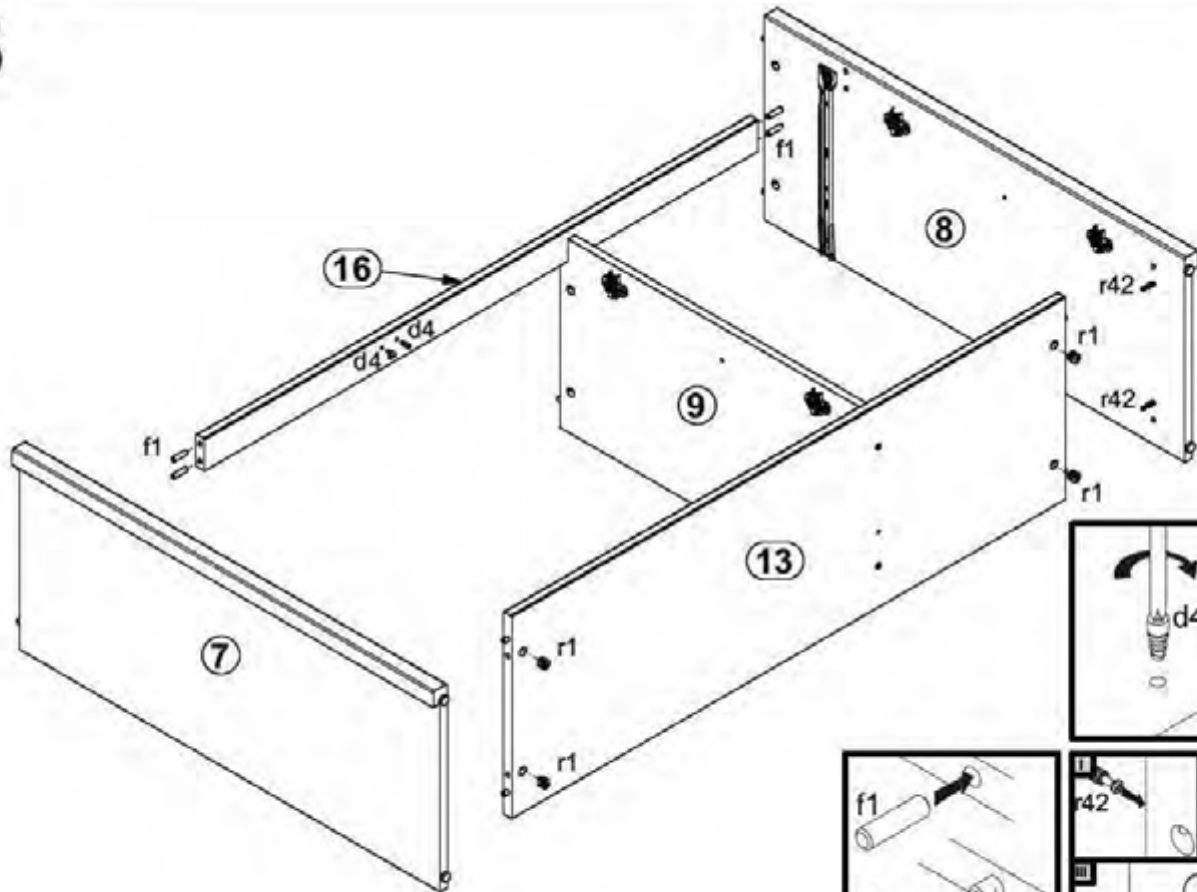

4

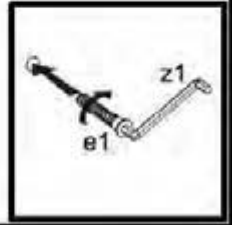
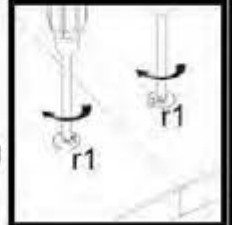
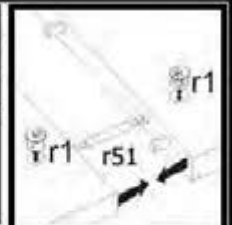
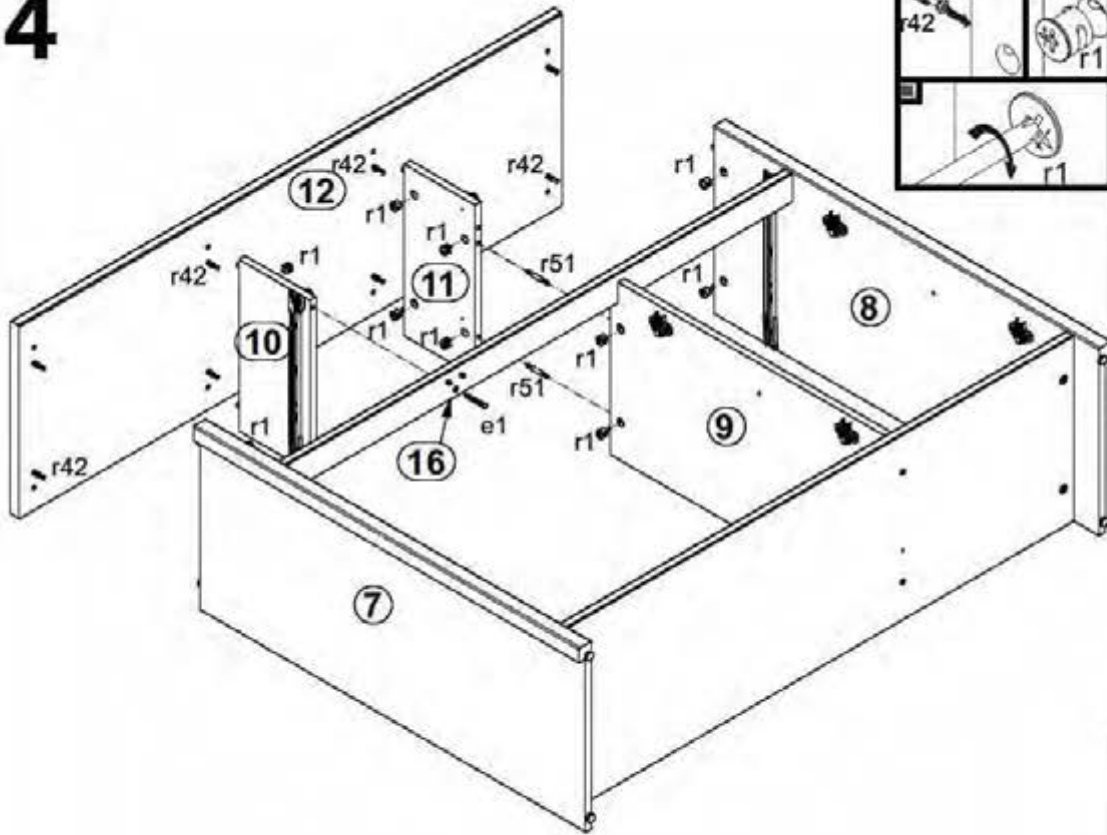

5

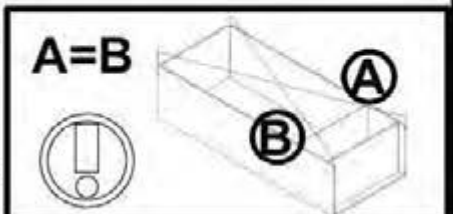
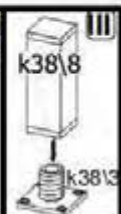
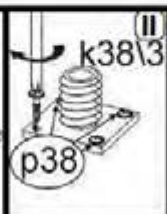
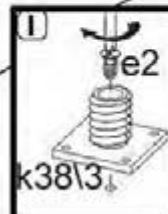
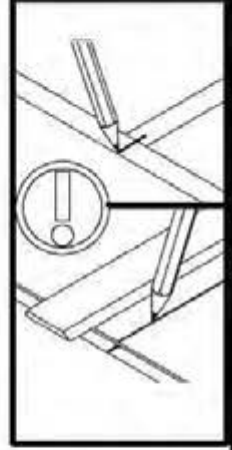
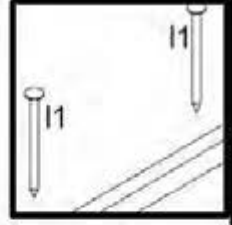
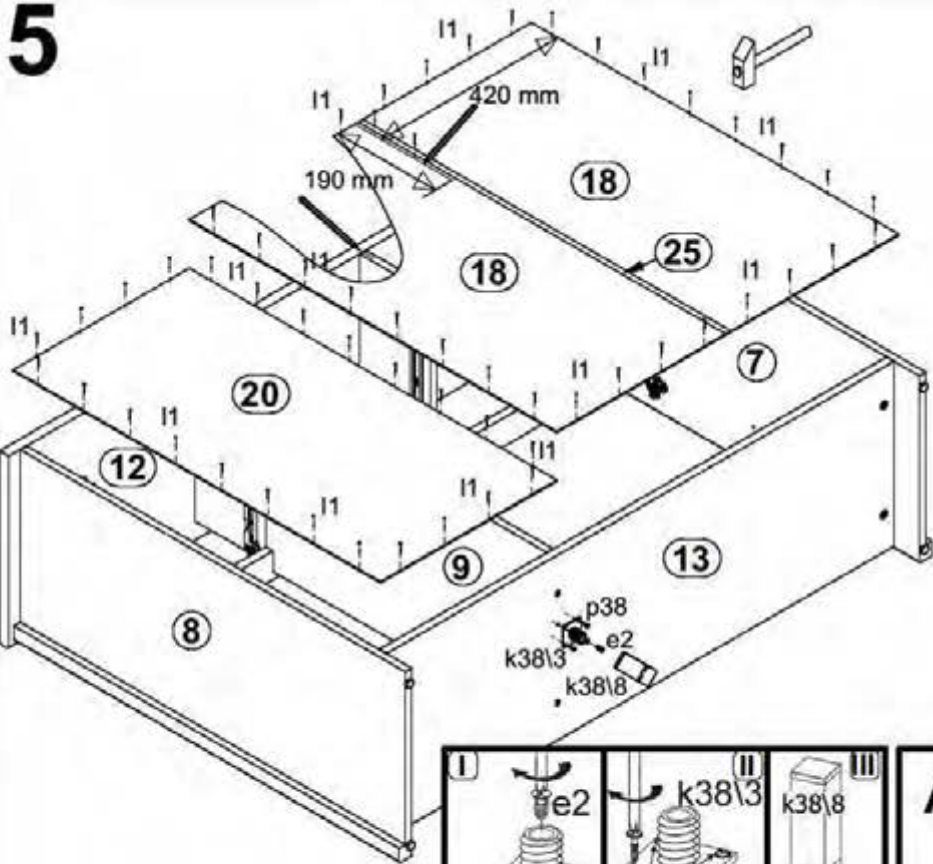

6

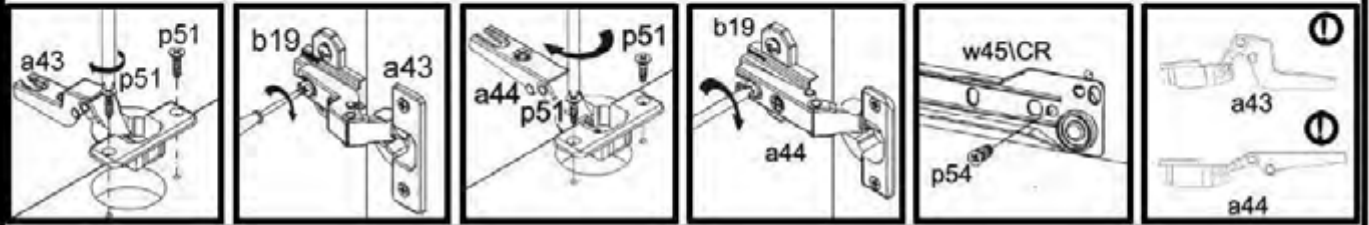
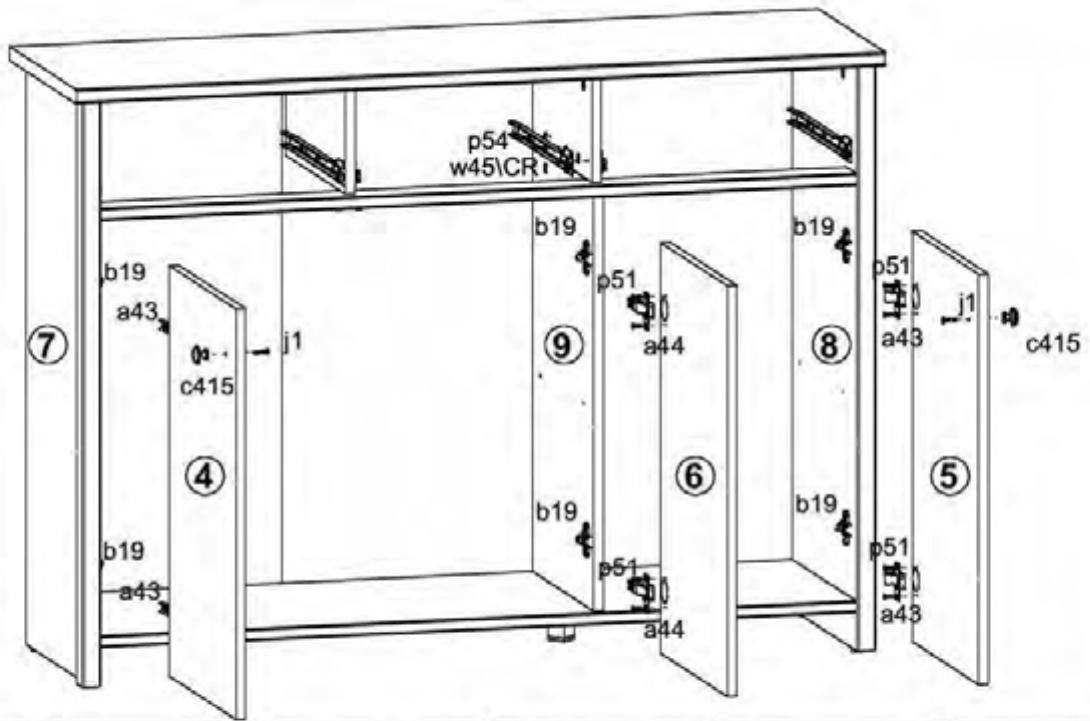

7

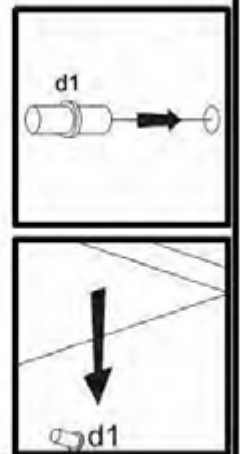
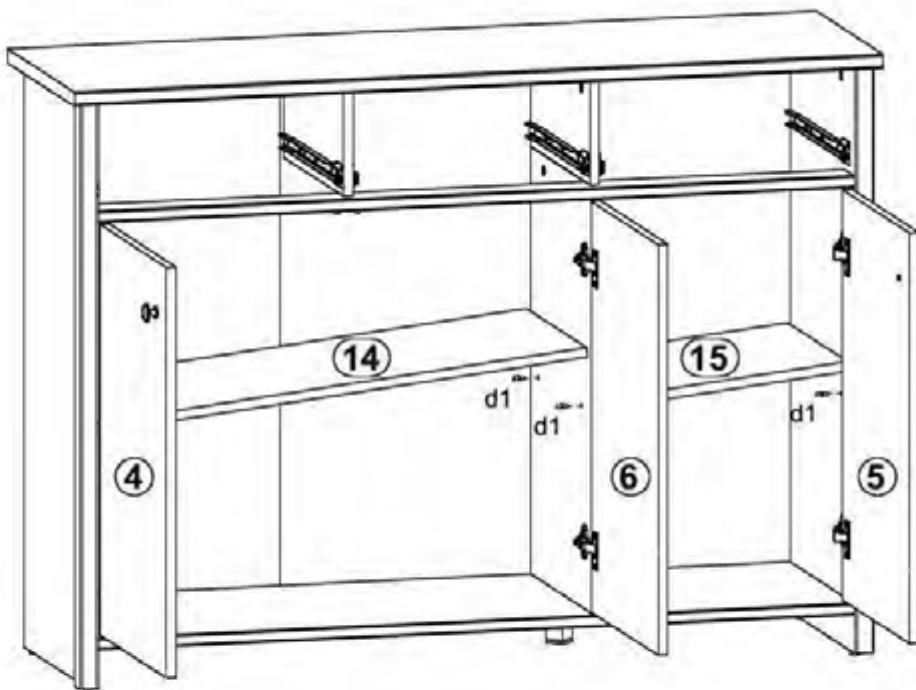

8

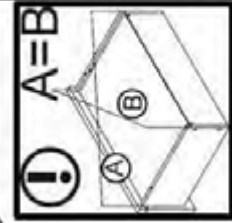
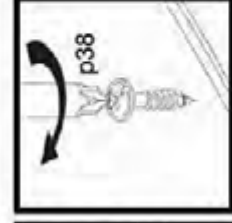
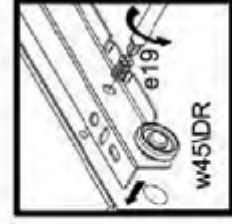
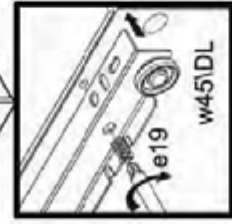
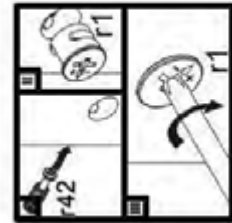
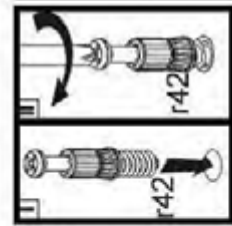
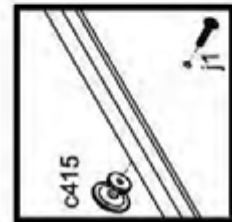
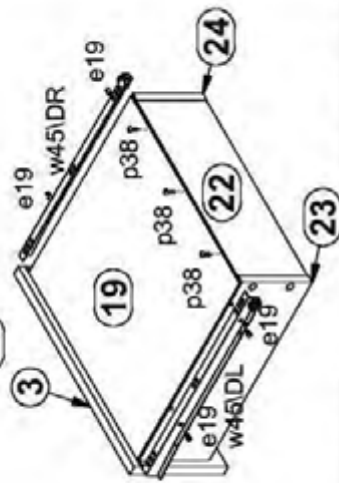
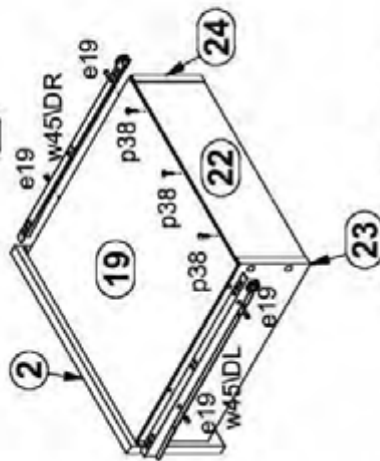
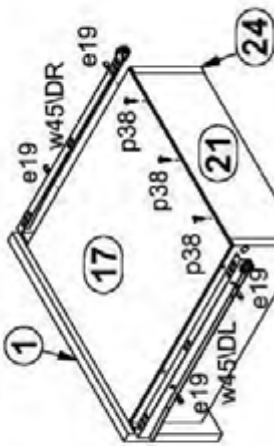
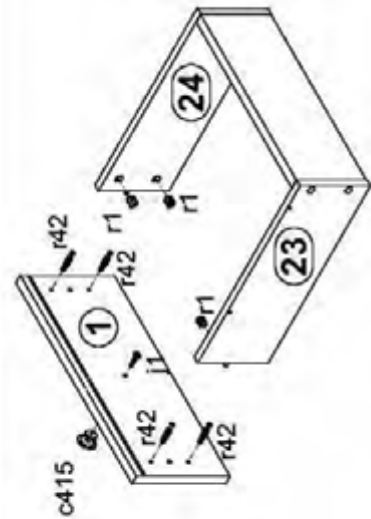
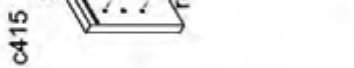
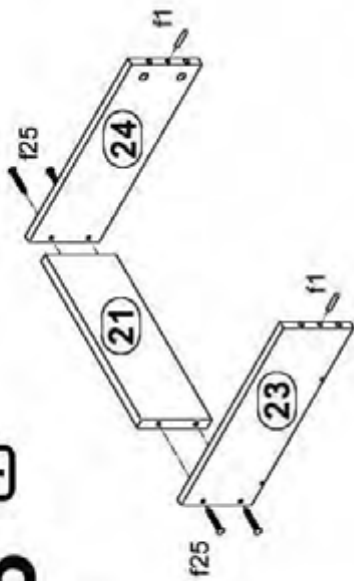

9

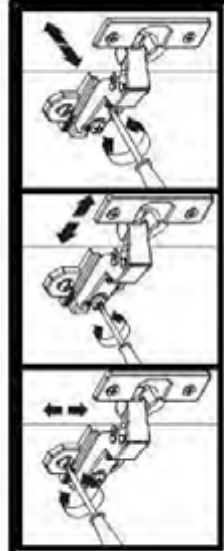
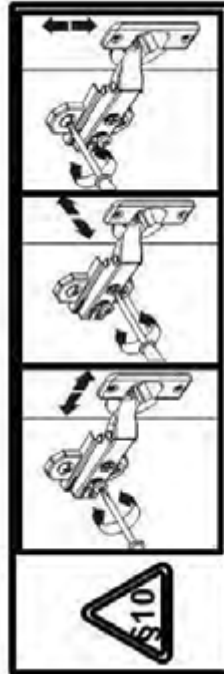
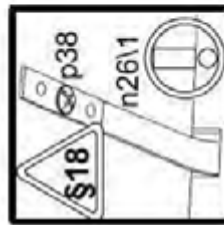
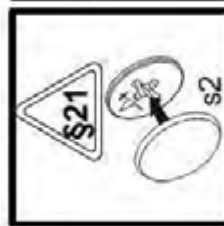
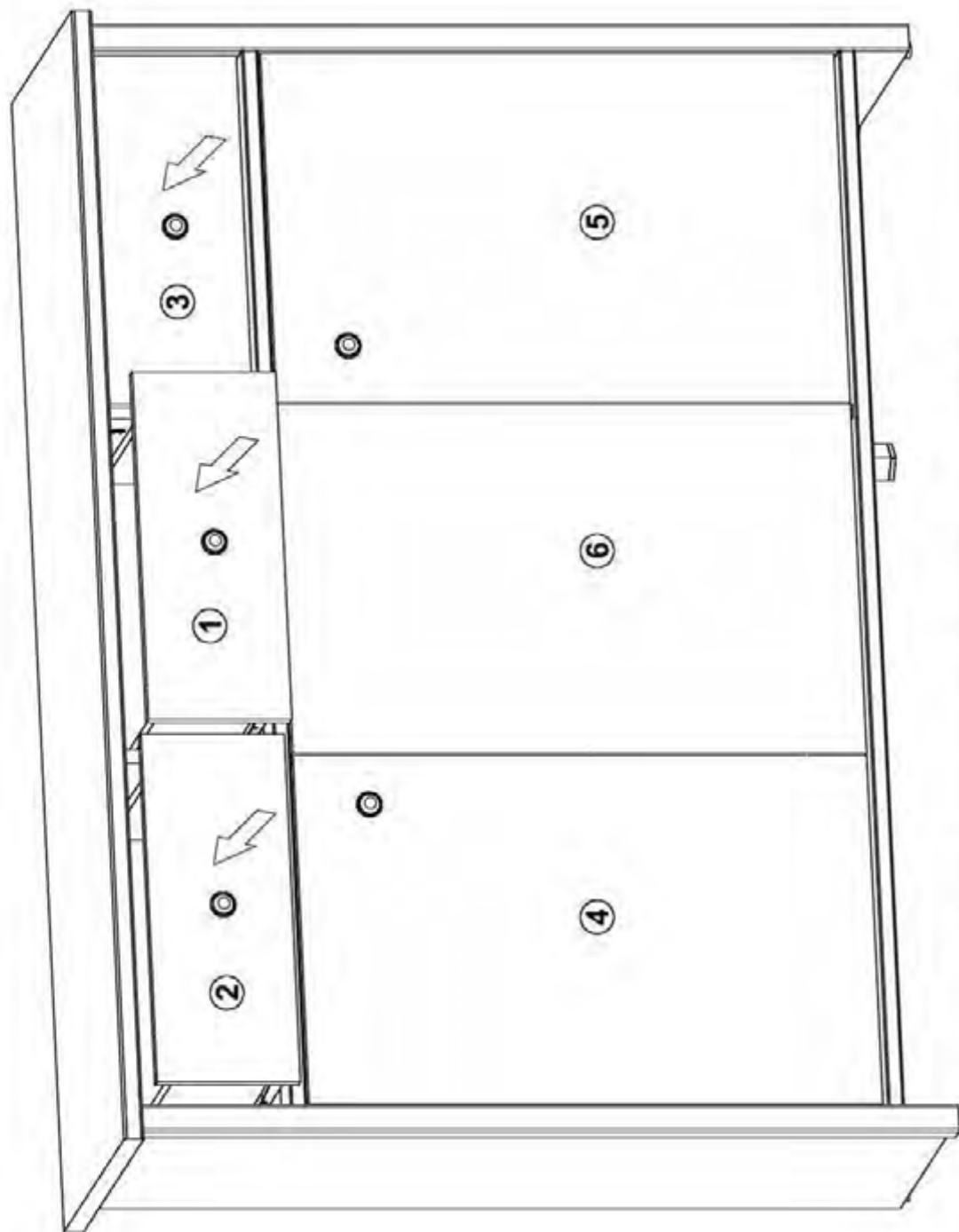

7/17

P26-S322-40-M0005