

MANUAL



OV05T

Introduction

Please read this manual before using the product in order to give you the needed product and installation instruction to assure a seamless installation and non compromised overall sound quality.

Thanks for purchasing our APart OVO5T speaker. Budget and quality sound united: welcome the OVO-speakers. This series of cabinet speakers fit into any décor or interior style. The OVO5T can be used in both 100V- and 16Ohm-systems thanks to an easily accessible selection switch. The OVO5T uses a new bracket system that allows a wide range of positioning. In case you want to place your OVO on a flat surface, you can remove the bracket. We have designed a stand incorporated in the foot of the speaker. The sturdy ABS plastic housing guarantees years of trouble free musical enjoyment. Affordable, but by no means a compromise on sound quality – typically APart!

Safety precaution

- Keep this manual for future reference.
- Take care of your speaker wires, they should be free of damage. Damaged speaker wires might result in poor sound quality and can damage amplifiers.
- Only use accessories specified by the manufacturer
- Make sure the ceiling can support the speakers weight.
- Use sufficient amount of speakers to avoid death-spots.
- No main power shall be connected to the loudspeakers, doing so will damage the speaker.
- This apparatus should only be serviced by qualified personnel. If not warranty might be void.
- The speaker grill is fixed, removing it will damage the speaker.
- Use cable of the right gauge, certainly for long runs.
- Use cables with clear color indication and maintain polarity throughout the

whole system.

- Avoid loud feedback from microphones, this can damage your speaker.
- Please check the units condition after unpacking. If the outside of the carton box has been damaged, inform your shipper immediately.
- Take notice that this speaker is intended for indoor use only. Do not expose the speaker to direct rain.

Features and benefits

- Inconspicuous and elegant design
- Remarkable quality sound and extremely affordable.
- 5.25 inch coated paper woofer and 1 inch silk dome tweeter.
- 80 Watts program power at 8 Ohm
- ABS plastic housing
- Mounting bracket that allows tilting and turning.
- Free stand incorporated in the housing for usage on flat surfaces.
- Quick fit cable clamps for quick and easy mounting.
- Indoor use only
- Can be painted in any RAL color from a minimum of 12 pieces. (ref.: PAINTCAB6)

Connecting the speaker

Use the correct polarity when daisy chaining speakers! When a mistake occurs in your daisy chain, it can severely impact speaker performance as there will be audio-cancellation.

The daisy chain options are endless and the setup will depend on the capabilities of your amplifier. Make sure when daisy chaining speakers that the total impedance is not lower than the lowest specified impedance of your amplifier. Not following this rule might result in distorted sound and might even damage your amplifier.

Series wiring speaker diagram:

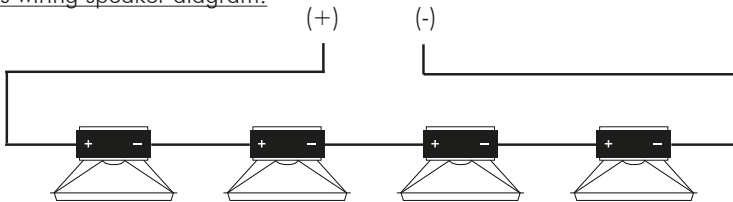

Total resistance = $R_1 + R_2 + R_3 + R_4 + \dots$

Parallel wiring speaker diagram:

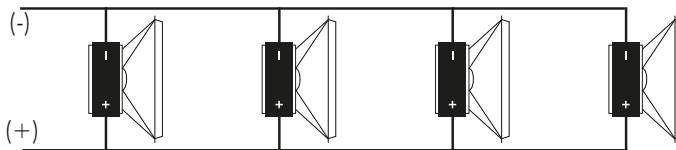

Total resistance = $\frac{1}{1/R_1 + 1/R_2 + 1/R_3 + 1/R_4 + \dots}$

R1 = Resistance of speaker 1

R2 = Resistance of speaker 2

R3 = Resistance of speaker 3

R4 = Resistance of speaker 4

100V technology

70 Watt \geq 20W+ 20W+ 10W+ 5W + 5W + 5W + 2.5W + 2.5W

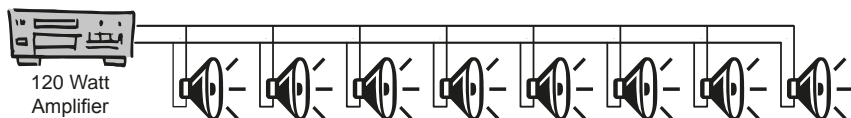

Amplifier power must be equal higher than total power of all speakers

Specifications

Woofers	5,25 inch coated paper
Tweeter	1 inch silk dome tweeter
Shape	cabinet
100 Volt power taps	30W, 15W, 6W, 3W
Music power RMS	80 W / 16 Ohm
Frequency response	70 Hz to 20 kHz
SPL 1W / 1m	90dB
SPL 1m / max rated power	109dB
Dispersion at 1kHz, 4kHz, 8kHz	180°, 90°, 70°
Color	white or black
Cabinet construction	ABS with bass reflex
Grille material	Steel
IP class	40
Fixing type	mounting bracket
Height (mm)	260mm
Width (mm)	170mm
Depth (mm)	180mm
Net weight (pair)	5,7Kg
Gross weight (pair)	6,6Kg

Polar diagram 1000 Hz

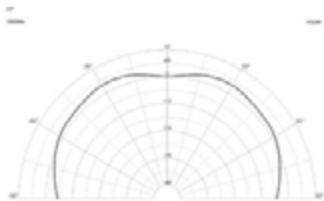

Polar diagram 4000 Hz

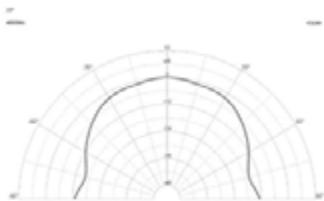

Polar diagram 8000 Hz

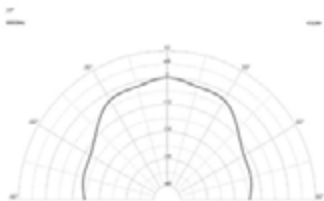

Technical drawing with measurements

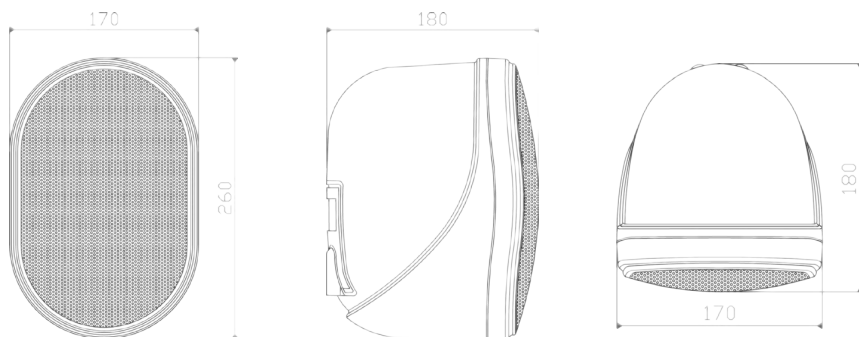

Warranty info

APart-Audio warrants this product to be free of defects in material and workmanship for a period of one year for parts and for a period of one year for labor from the date of original end-user purchase. This warranty is valid only for the original end-user and cannot be transferred.

During the warranty period APart-Audio or one of its authorized service partners shall either repair or replace any product, free of charge, that proves to be defective on inspection by APart-Audio or its authorized service representative.

This warranty does not include, damages or product faults due to abuse, misuse or faulty installation.

Company names, product names, and names of formats etc. are the trademarks or registered trademarks of their respective owners.

© 2011 APart-Audio specifications subject to change without notice.

developed by

*Audioprof nv
Industriepark Brechtsebaan 8 bus 1
2900 Schoten
Belgium*

