

A	B	C	D	
1	S322-0031	865	348	4/4
2	S322-1144	434	368	1/4
3	S322-1145	434	368	1/4
4	S322-2215	954	379	1/4
5	S322-2216	954	337	1/4
6	S322-3330	870	365	1/4
7	S322-3331	869	341	1/4
8	S322-4419	1800	902	2/4
9	S322-4420	1404	559	3/4
10	dr-292	292	22	1/4

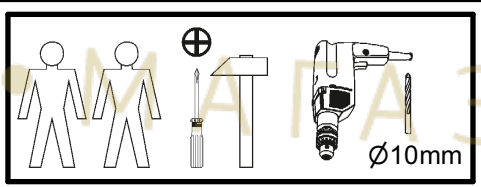

2x a43	2x b19	1x c415	4x d1	7x e1	20x f1	2x f35	3x g49	1x j1
6x j60	4x k1	2x m48	2x n1	2x n14	2x o21	10x p1	2x p17	4x p38
4x p51	17x r1	17x r42	10x s2	1x z1				

1

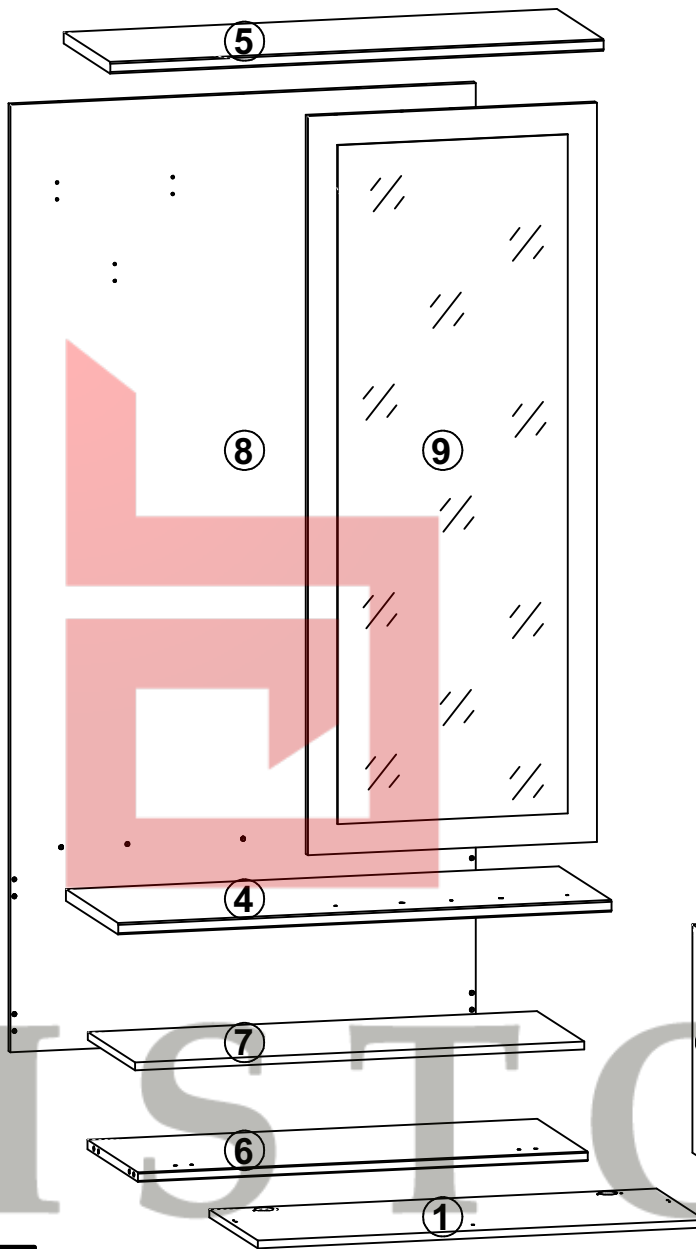
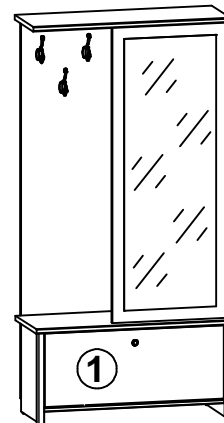
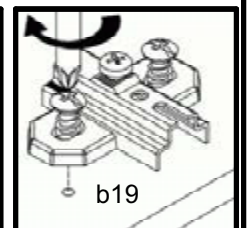
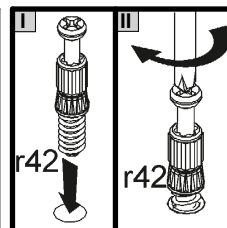
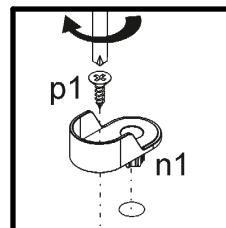
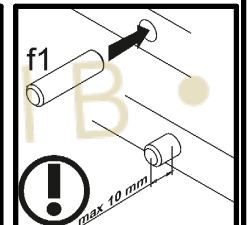
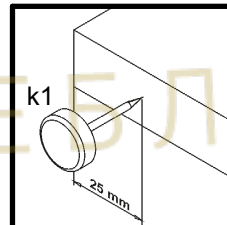
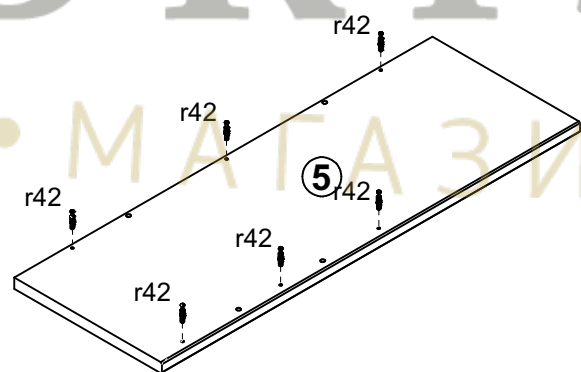
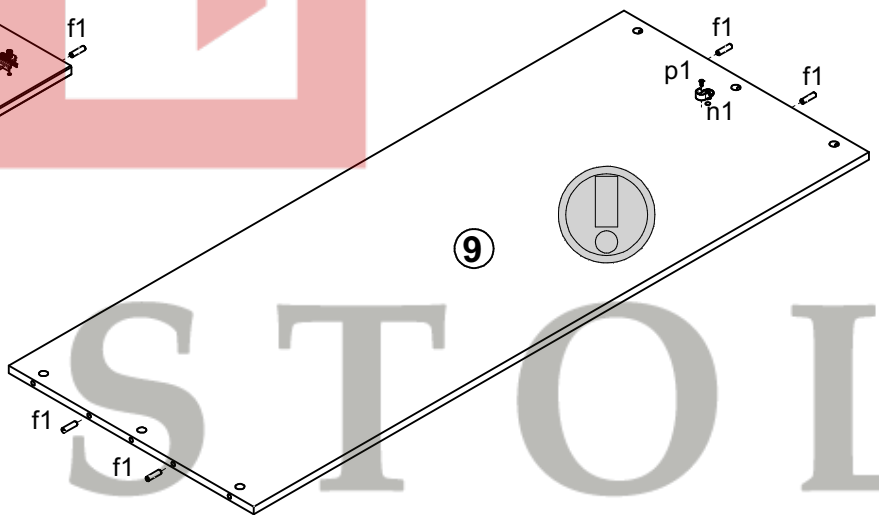
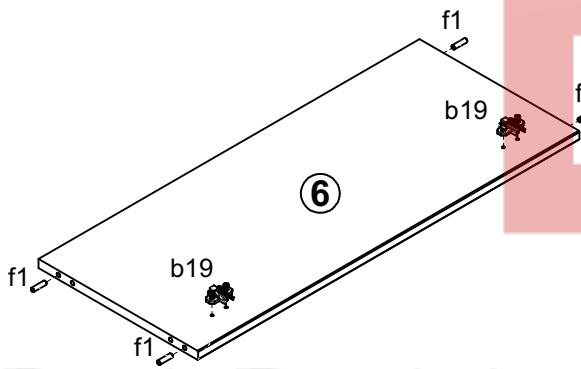
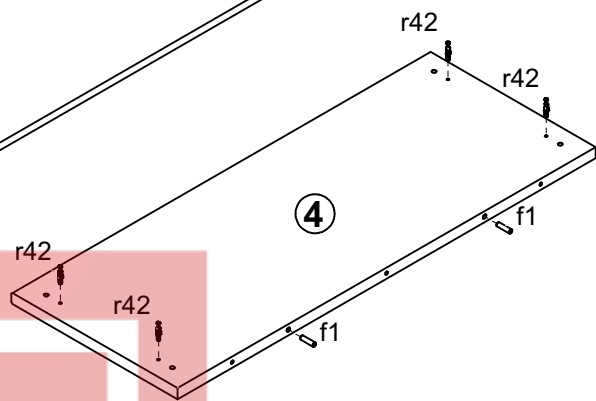
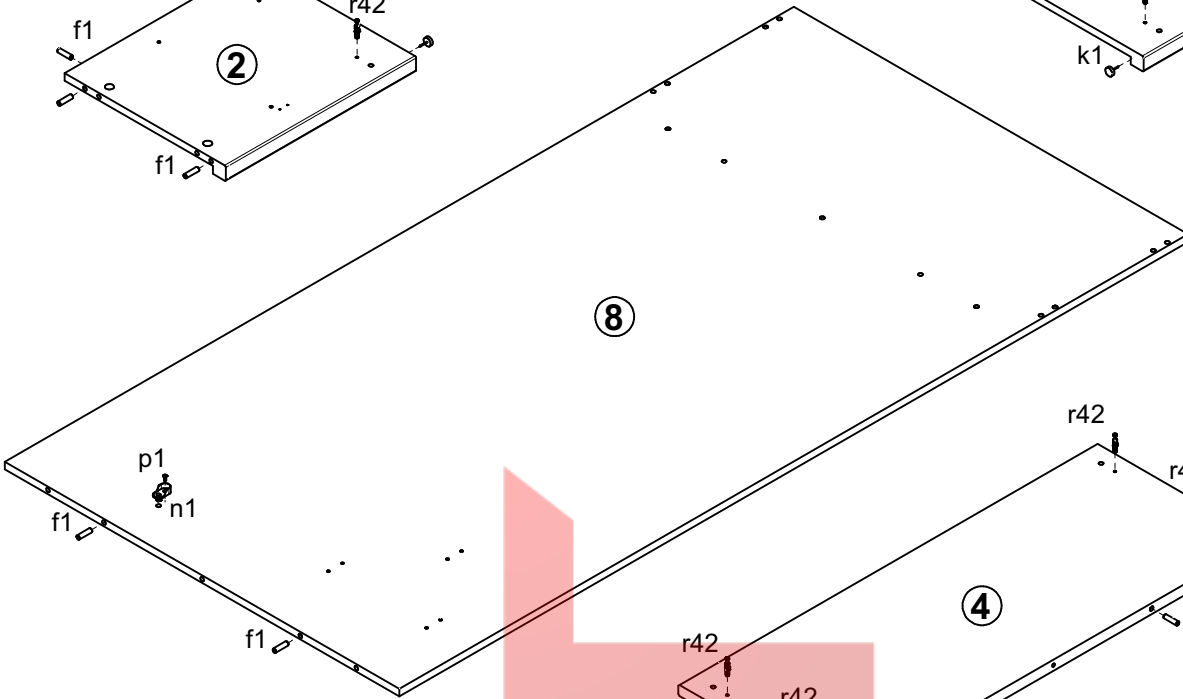
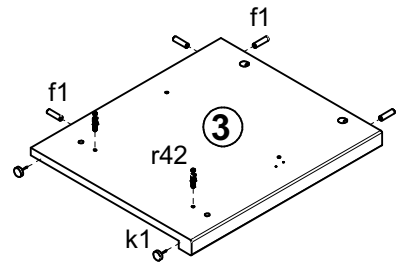
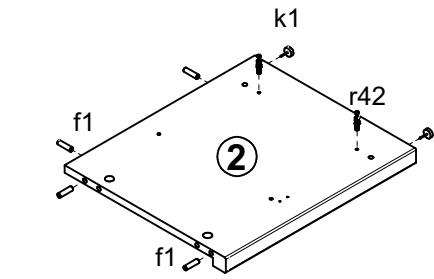

2

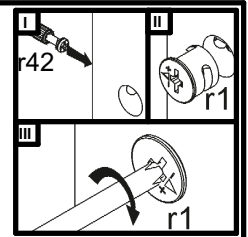

I

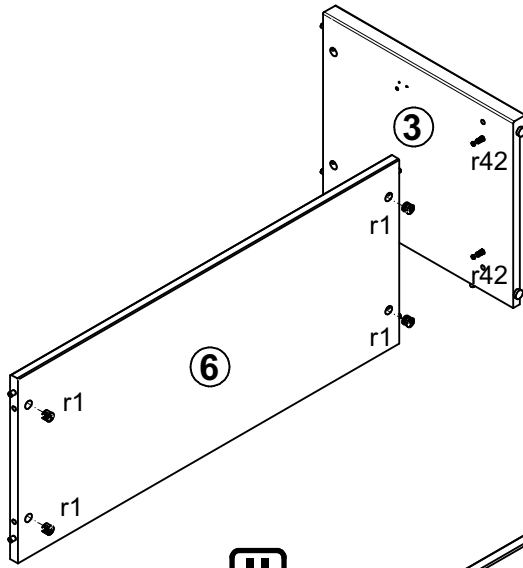
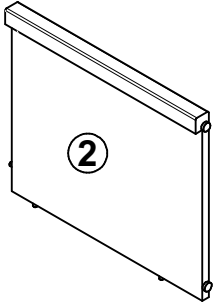

II

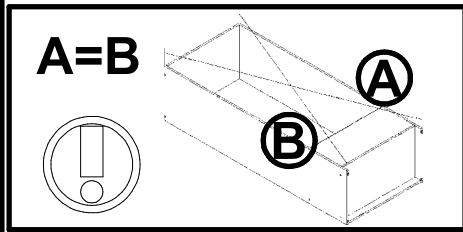
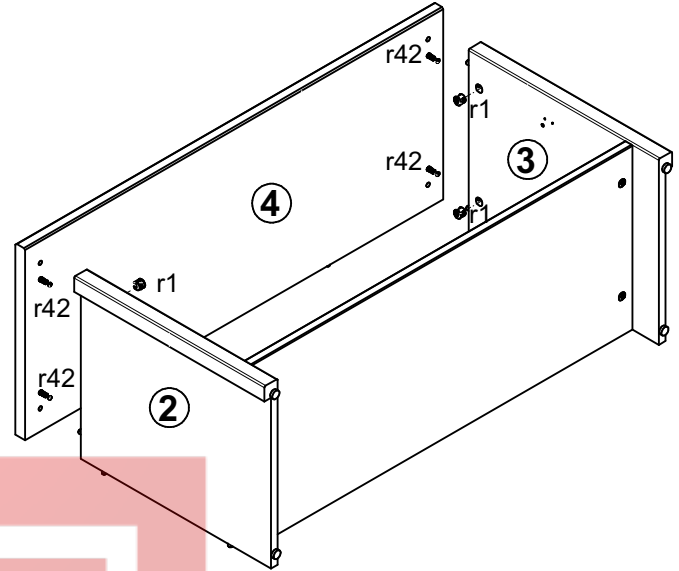

3

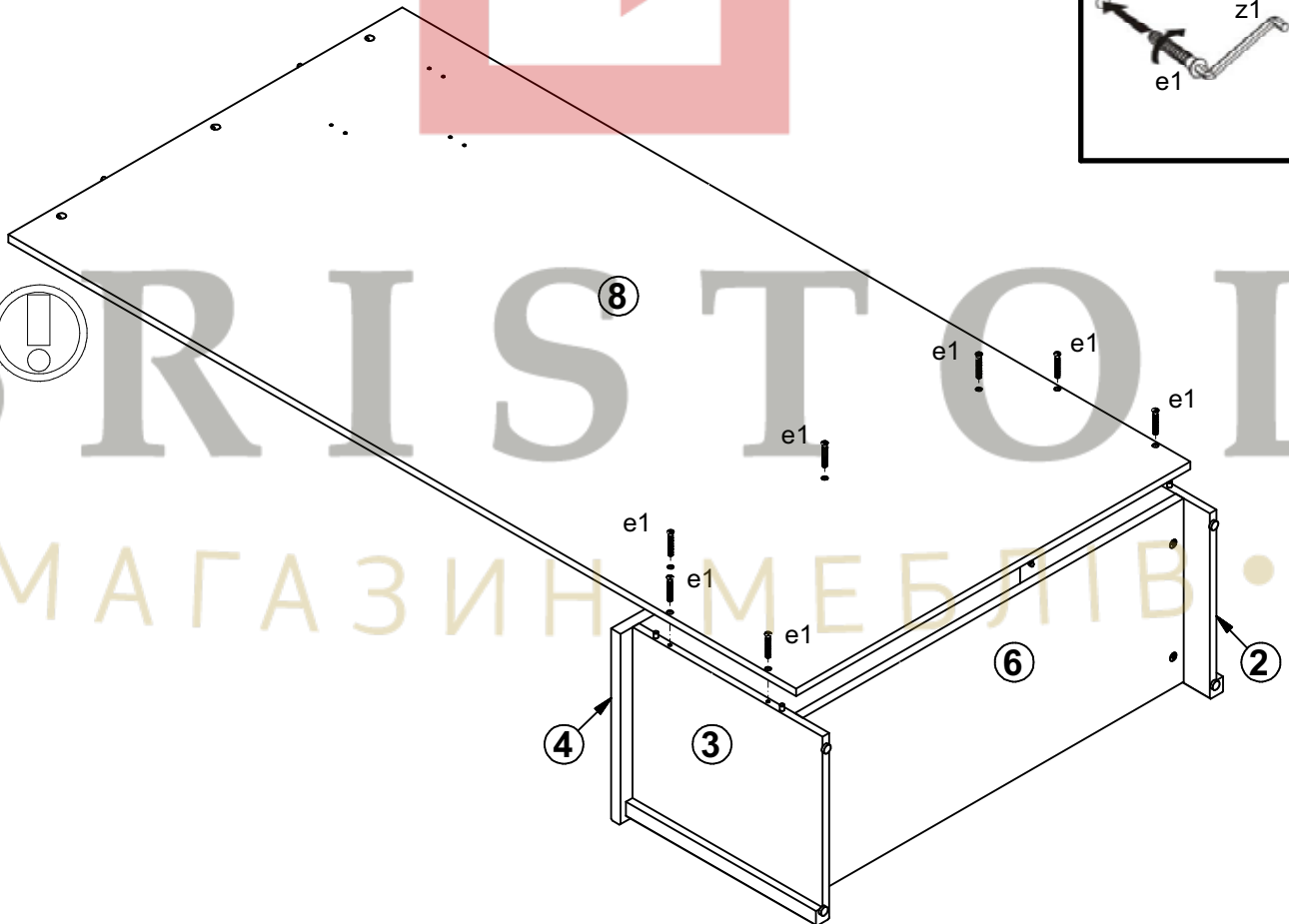
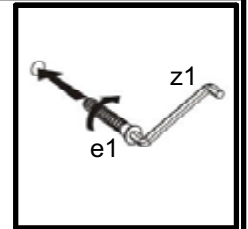

4

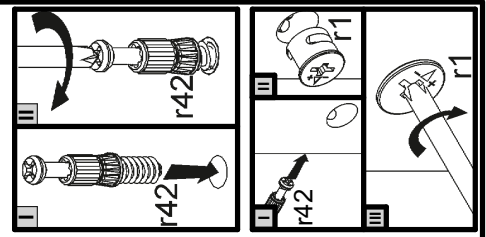
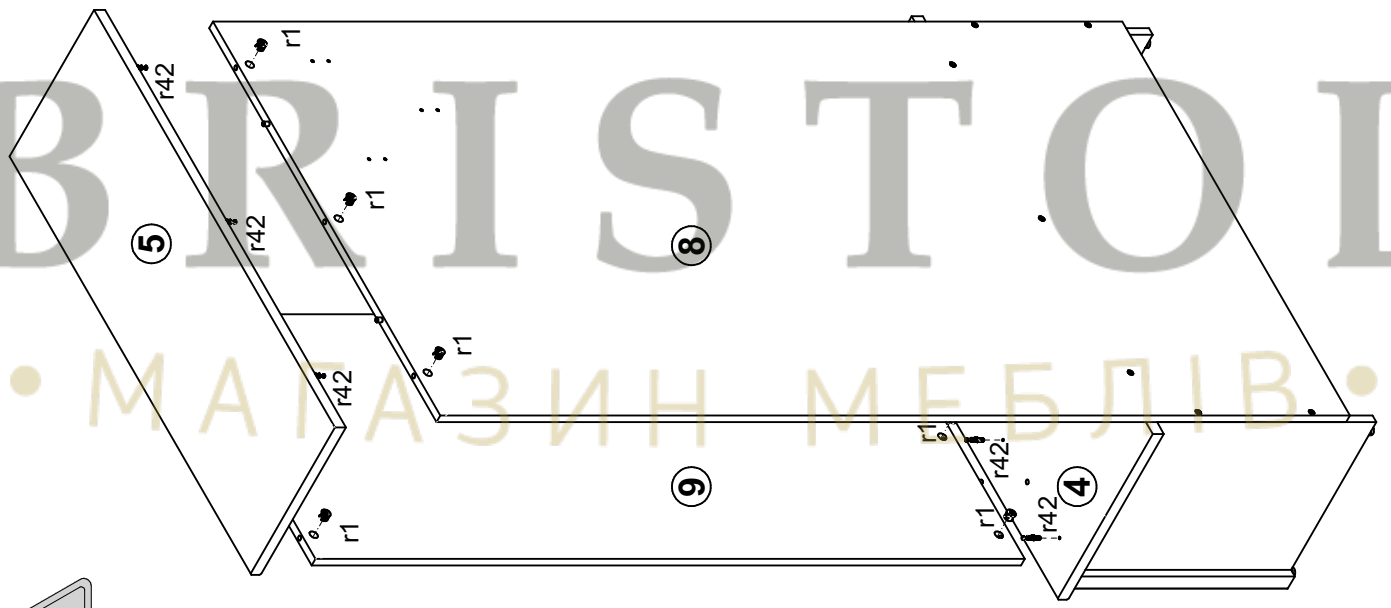

5

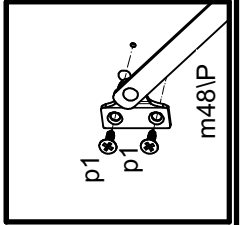
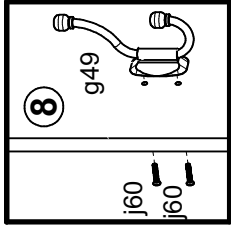
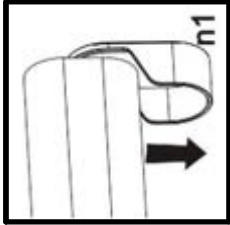
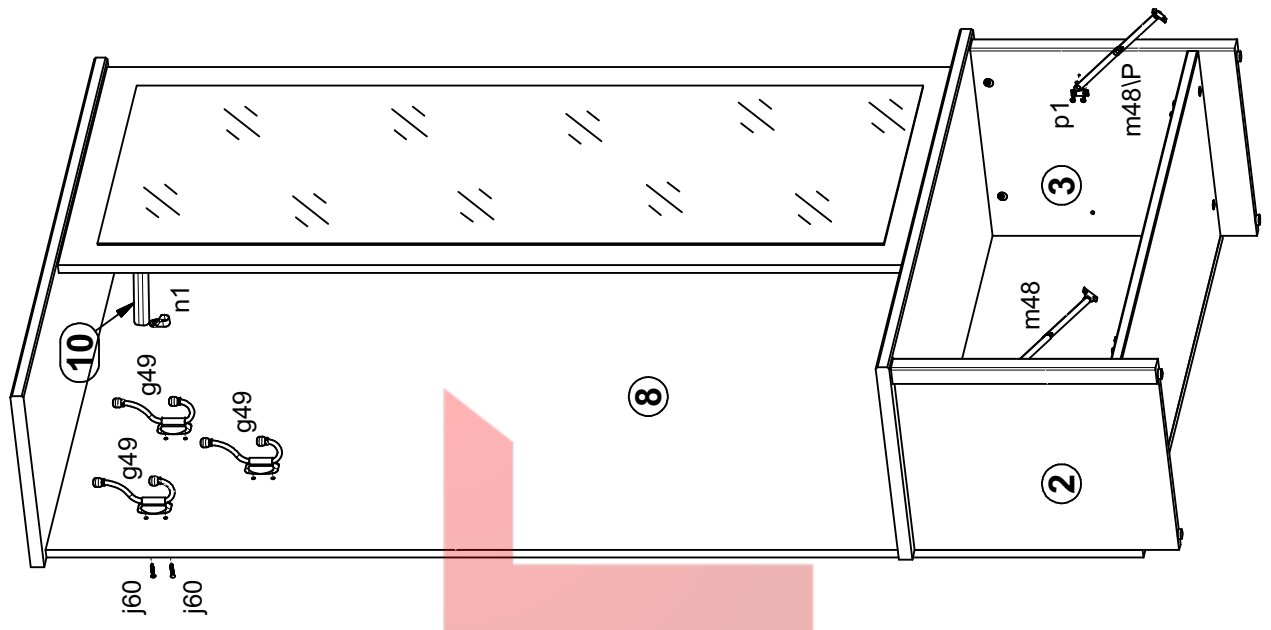

6

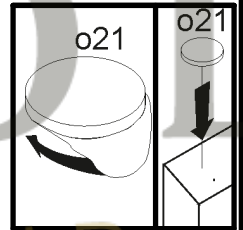
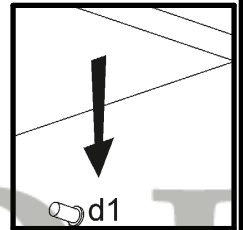
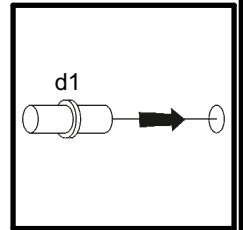
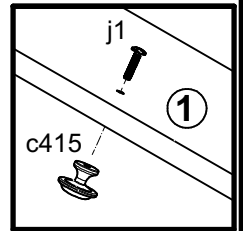
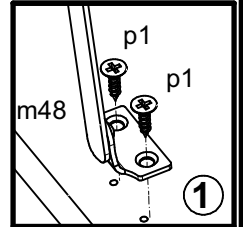
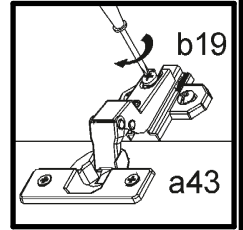
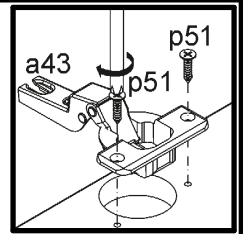
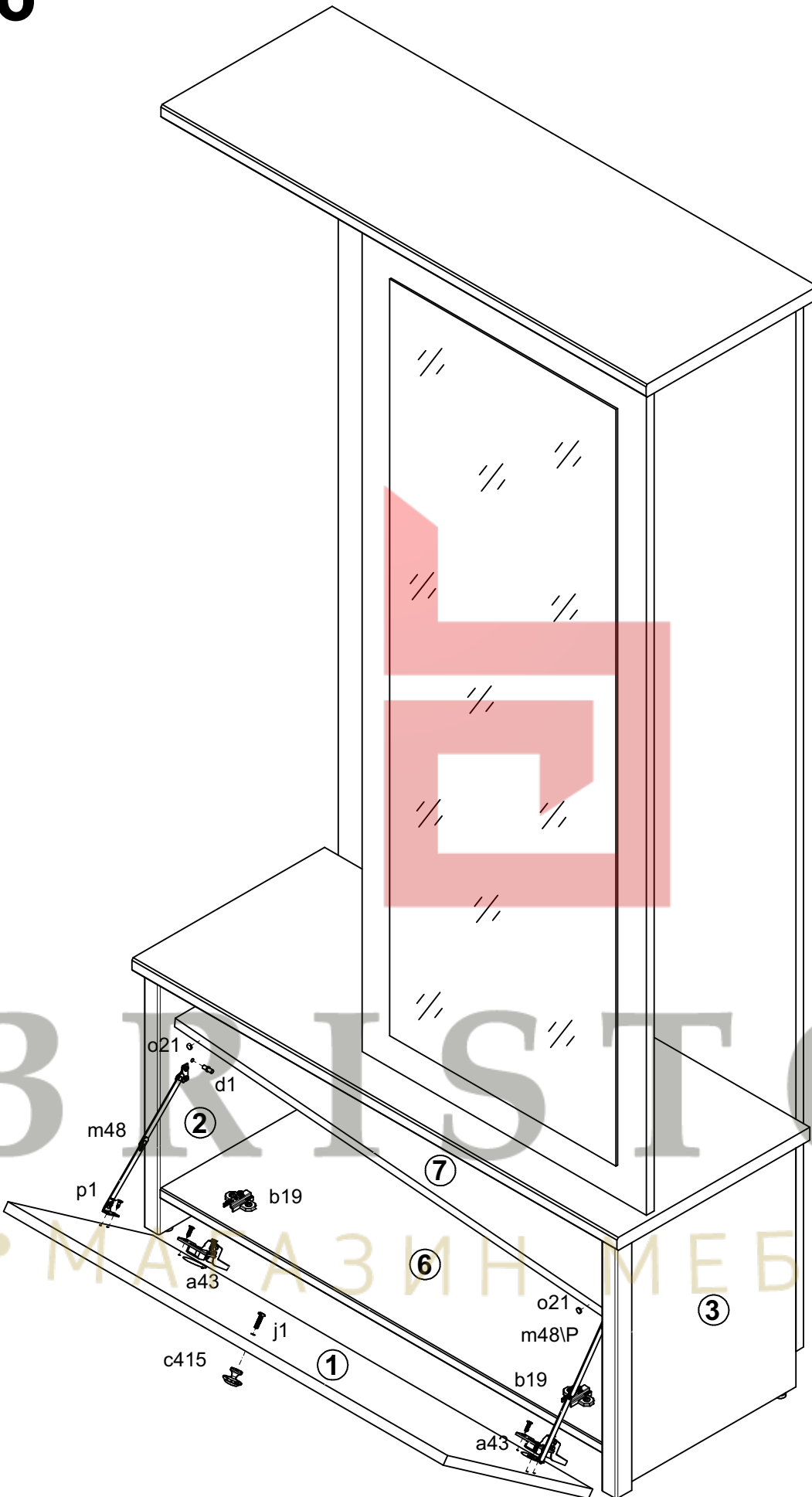

7

