

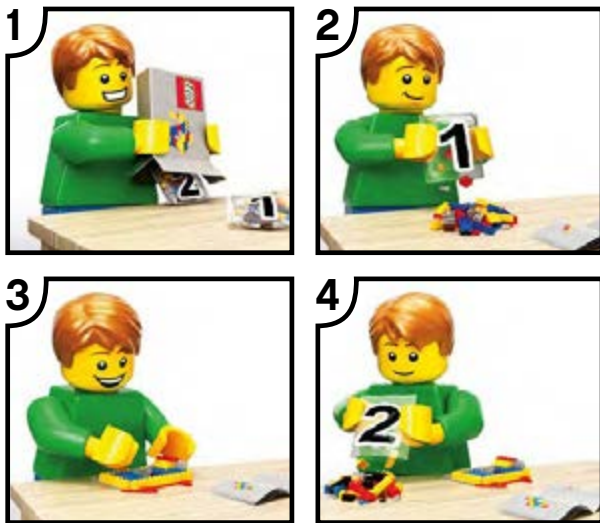

CLASSIC

11013





2



- 1** Scan the code on the front cover
 Scanne den Code auf der Titelseite
 Scanne le code sur la page de couverture
 Scanner le code sur la page couverture
 Scansiona il codice sulla copertina
 Escanea el código de la portada
 Faz scan do código na frente da capa
 Olvasd be a borítón látható kódot!
 Noskenē kodu uz priekšējā vāka
 扫描封面上的二维码



- 2** Get Instructions PLUS
 Hol dir Instructions PLUS
 Obtens les instructions PLUS
 Obtenir les Instructions PLUS
 Scarica Instructions PLUS
 Descubre Instructions PLUS
 Obtém Instruções PLUS
 Szerezd be az Instructions PLUS kiegészítőt!
 Saņem "Instructions PLUS"
 获取更多说明

LEGO.com/apps

Check for compatibility
 Kompatibilität prüfen
 Vérifier la compatibilité
 Controlla la compatibilità
 Comprueba tu compatibilidad

Verificar a compatibilidade
 Ellenőrizd a kompatibilitást
 Pārbaudīt saderību
 检查兼容性

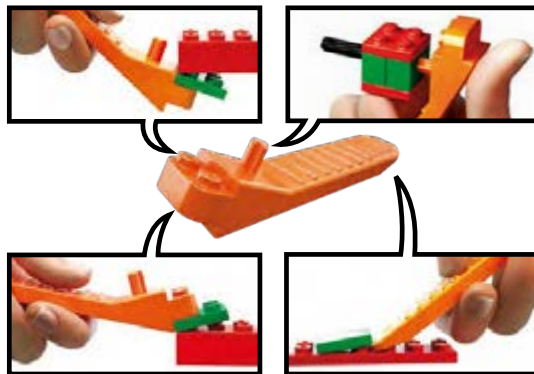

[LEGO.com/brickseparator](https://lego.com/brickseparator)



Page
6



Page
21



Page
41



Page
11



Page
29



Page
52

Page
Seite
Página
Pàgina
Oldalszám
Lpp.
页码

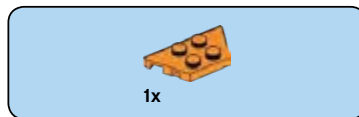
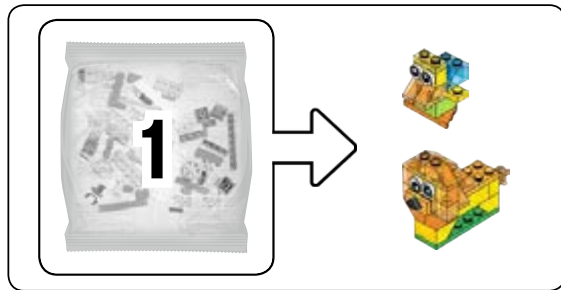

1

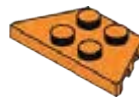



2

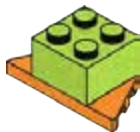

3

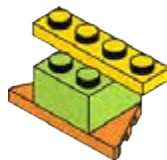



4



8

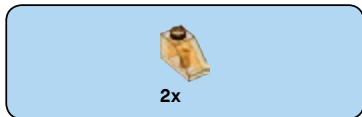

5

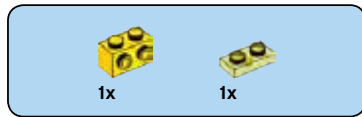
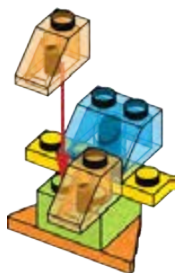

6

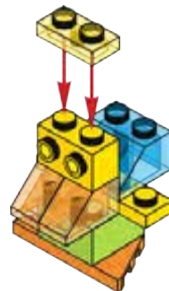

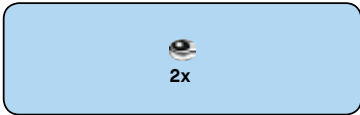

7



10

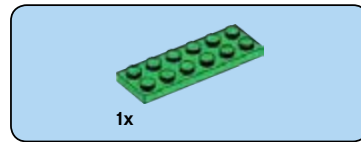

1

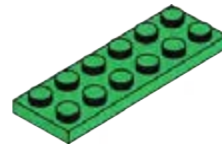



2

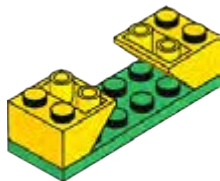

12

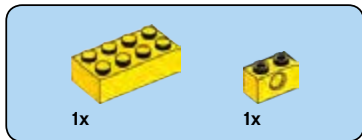

3

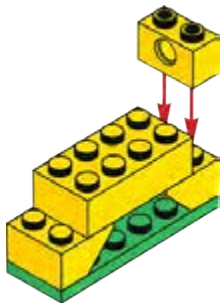

4

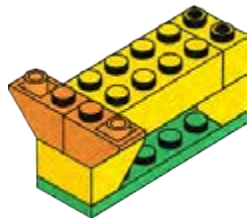

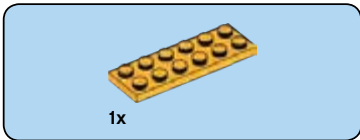

5

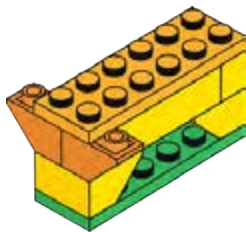

14



6

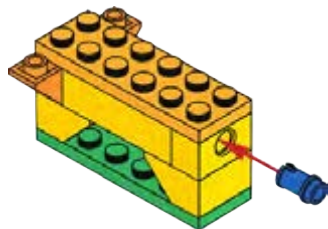

7

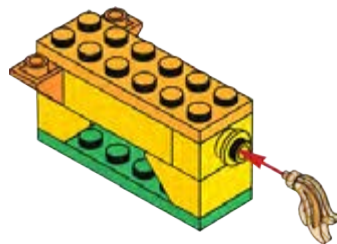



8

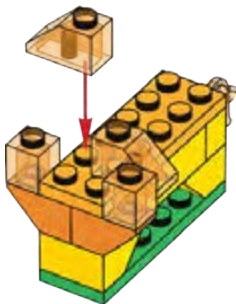

16

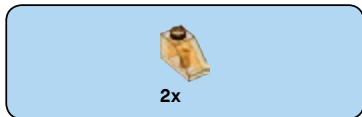

9

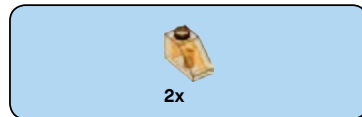
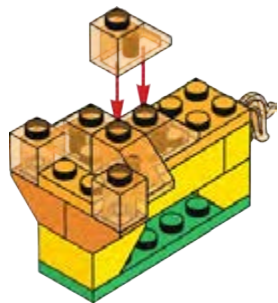

10

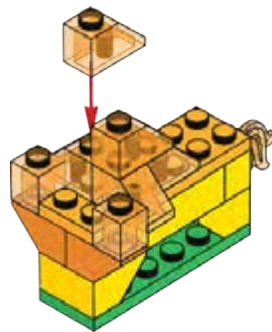



11

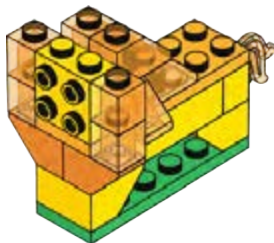

18



12

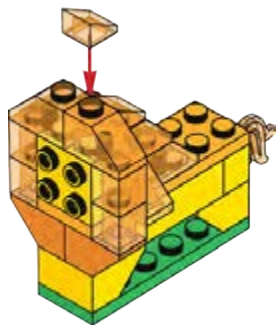

13

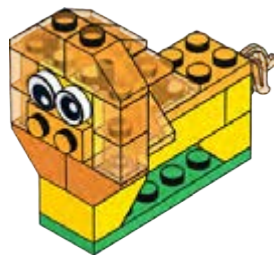



14

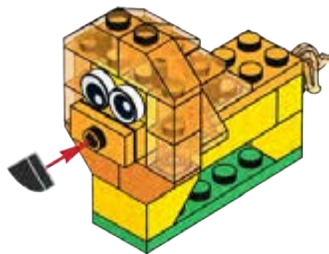

20

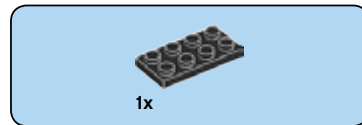
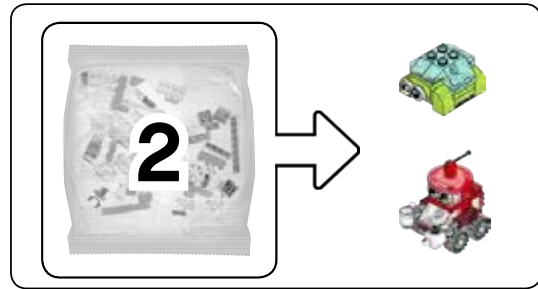

1

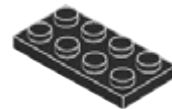



2



22



3

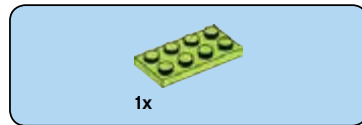

4

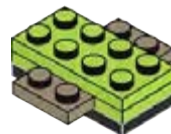



5

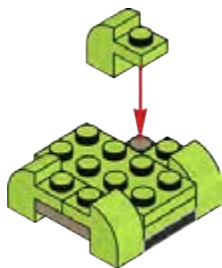

24

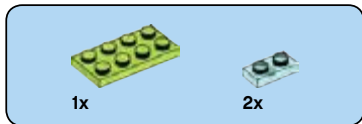

6

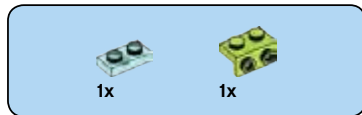
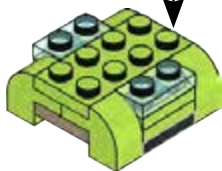

7

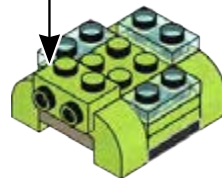

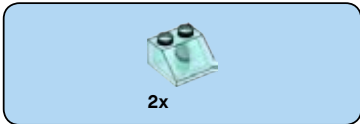

8

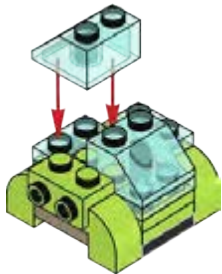

26

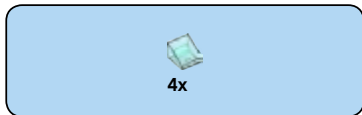

9

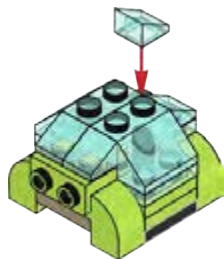

10

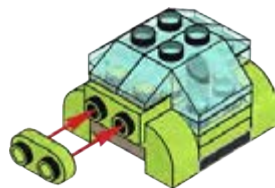

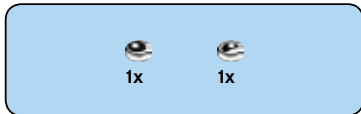

11



28

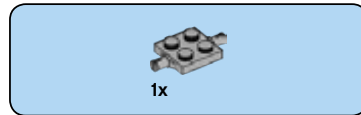

1



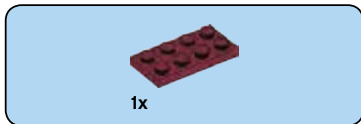

2



30

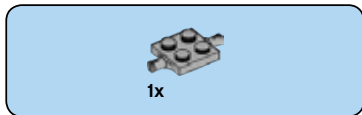

3

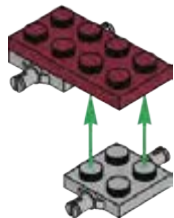

4





5



32

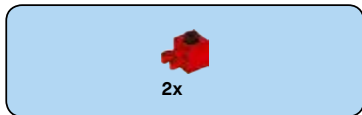

6

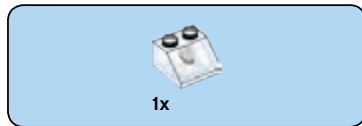

7



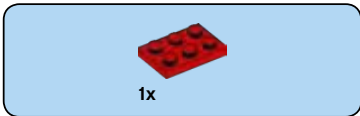

8



34

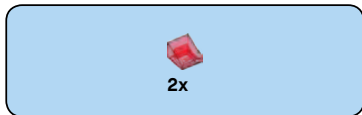

9



10





11



36

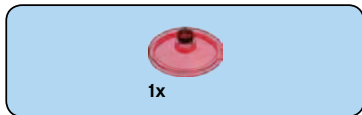

12

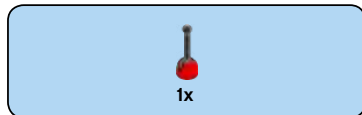

13



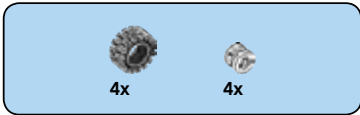

14

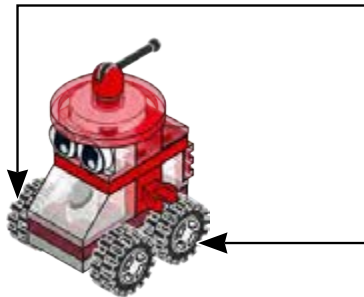
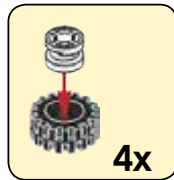

38



15

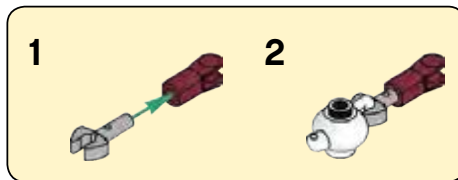



16

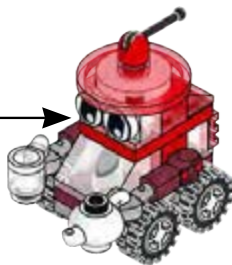
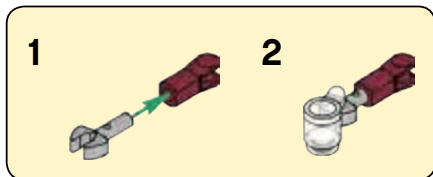

40

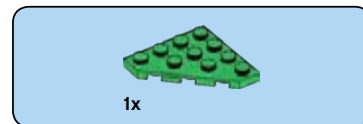
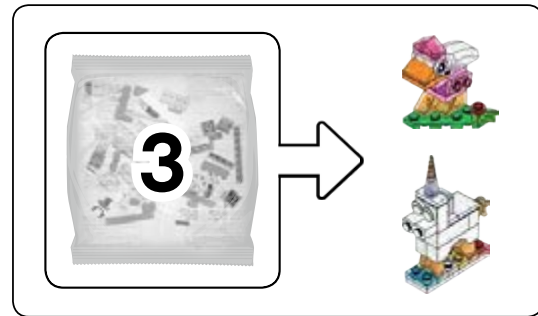

1



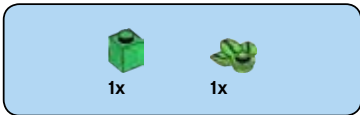

2

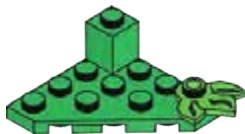

42

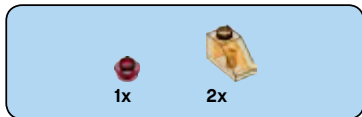

3

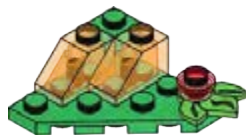

4





5



44



6



7



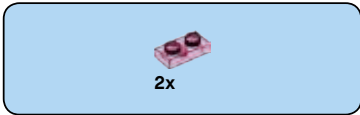

8

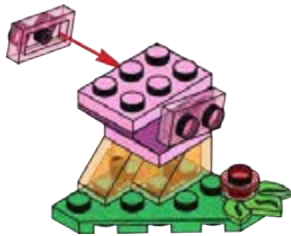

46

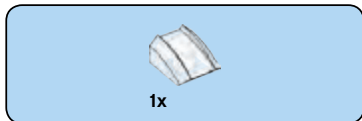

9





10



48



11



12

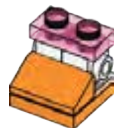



2x

13

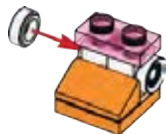

50



14



15

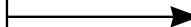

51

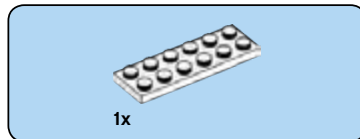

1





2

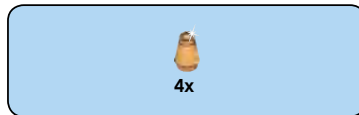

3



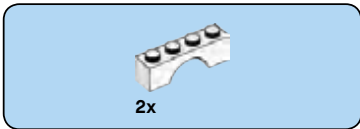

4

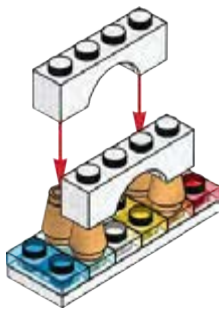

54

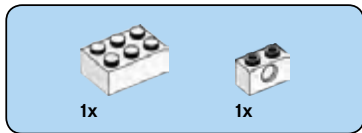

5

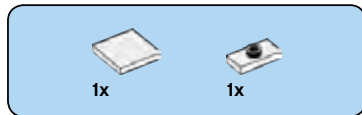
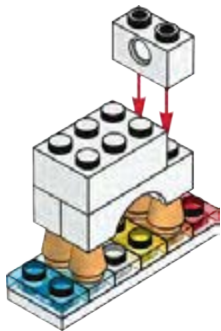

6

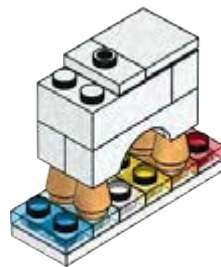



7

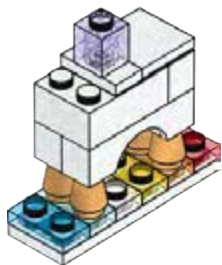

56

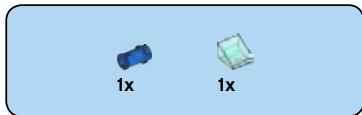

8

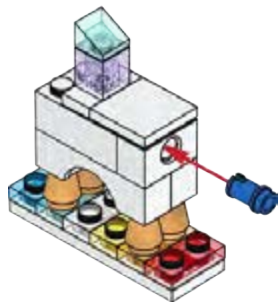

9

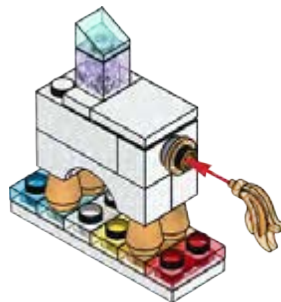

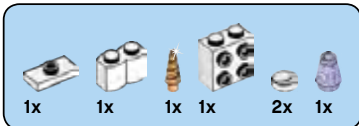

10

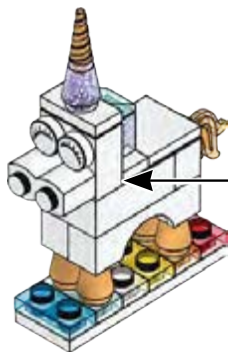
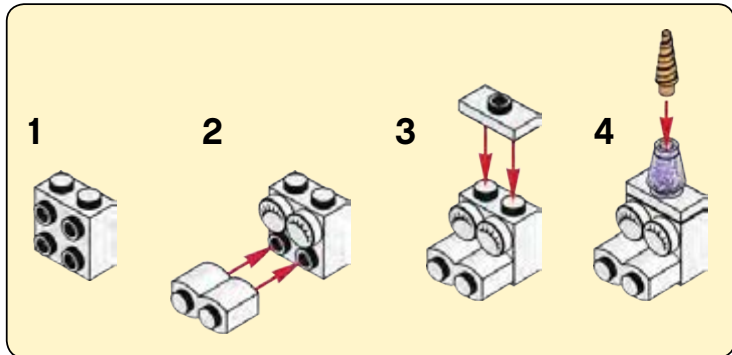

58



CLASSIC



What fun things can you build?
Welche lustigen Sachen kannst du bauen?
Quels objets amusants peux-tu construire ?
Quali cose divertenti sai costruire?
¿Qué cosas divertidas puedes construir?
Que coisas divertidas consegues construir?
Milyen mókás dolgokat tudsz megépíteni?
Kādas interesantas lietas tu uzbūvēsi?
你能拼搭出什么有趣的模型呢？



TM.by
ONLINE STORE

<https://tm.by>
Интернет-магазин TM.by



CLASSIC



10698



10696



10713



11014



11010



10700



10714



10701



[LEGO.com/classic](https://lego.com/classic)

LEGO and the LEGO logo are trademarks of the LEGO Group. ©2021 The LEGO Group. 6349717